

MITSUBISHI

Electronic Multi-Measuring Instrument

Programming Manual (CC-Link)

Model

ME96NSR-MB or ME96NSR with optional Plug-in Module : ME-0040C-NS96

CONTENTS

1. General Description.....	2
2. Specification	2
3. Configuration Conditions of CC-Link System	3
4. Parameter Settings.....	4
4.1 Procedure from Parameter Settings to Data Link Startup	4
4.1.1 CPU Parameter Area and Master Module Parameter Memory	4
4.1.2 Procedure for Parameter Settings to Data Link Startup with GX Developer.....	4
4.2 Parameter Setting Items	5
4.3 Example of Parameter Settings with GX Developer.....	6
4.3.1 Master Station Network Parameter Settings	6
4.3.2 Master Station Automatic Refresh Parameter Settings	10
5. Communication Between the Master Station and ME96NSR.....	12
5.1 Communication Guideline	12
5.2 Initial Communication.....	13
5.3 Normal Communication.....	14
5.4 Error Communication	14
6. Remote I/O and Remote Register	15
6.1 Remote Input RX, Remote Output RY	15
6.1.1 Remote input RX.....	15
6.1.2 Remote Output RY.....	16
6.2 Remote Register (RW _r , RW _w).....	17
6.2.1 Supported Command.....	17
6.2.2 Details of Commands.....	18
6.2.3 About Error Occurrence	34
7. Abbreviations and Special Terms	35
8. Program Example.....	36
8.1 Program Content.....	36
8.2 System Configuration.....	36
8.3 Device Allocation.....	37
8.4 Parameter Settings	38
8.4.1 Network Parameter Settings and Auto Refresh Parameter Settings	38
8.4.2 Operational Settings	39
8.4.3 Station Information Settings	39
8.5 Program Example	40
9. Test Function Mode.....	49
9.1 How to Test	49
9.2 Reply Data	49

1. General Description

This manual describes the programming methods that should be created by the user for monitoring measurement value of the Electronic Multi-Measuring Instrument (called ME96NSR from here on) with the PC CPU through Control & Communication Link (abbreviated as CC-Link from here on).

In programming, read the following related manuals in addition to this manual.

Table 1.1 Related Manuals

Manual Name	Manual No.
CC-Link System Master/Local Module User's Manual Type:QJ61BT11	SH(NA)-080016
CC-Link System Master/Local Module User's Manual Type:QJ61BT11N	SH(NA)-080394
User's Manual for ME96NSR	Supplied with product

2. Specification

ME96NSR specification is shown in Table 2.1.

Table 2.1 ME96NSR Specification

Item	Specification
Station type	Remote device station
Number of occupied stations	1 station
Maximum number of stations per master station	42 stations (In case of connecting only remote device station occupied by 1 station.)
Transmission speed	156kbps/625kbps/2.5Mbps/5Mbps/10Mbps
RX, Ry	32 points each
RWw, RWr	4 points each

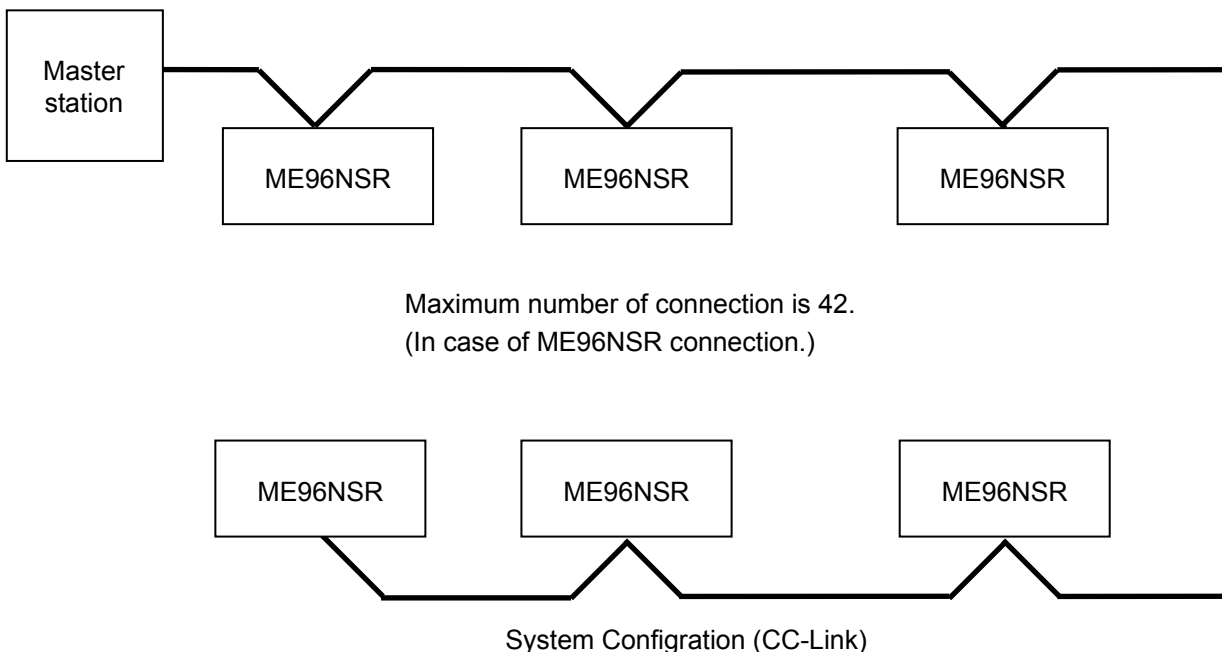

3. Configuration Conditions of CC-Link System

A total of 64 remote I/O stations, remote device stations, or local stations can be connected for one master station. Station type of ME96NSR is remote device station, and the number of occupied stations is 1 station.

However, the following conditions must be satisfied:

- (1) $\{(1 \times a) + (2 \times b) + (3 \times c) + (4 \times d)\} \leq 64$
 a: Number of modules occupying 1 station (ME96NSR is applied.)
 b: Number of modules occupying 2 stations
 c: Number of modules occupying 3 stations
 d: Number of modules occupying 4 stations
- (2) $\{(16 \times A) + (54 \times B) + (88 \times C)\} \leq 2304$
 A: Number of remote I/O stations ≤ 64
 B: Number of remote device stations (ME96NSR is applied.) ≤ 42
 C: Number of local stations, standby master stations and intelligent device stations ≤ 26

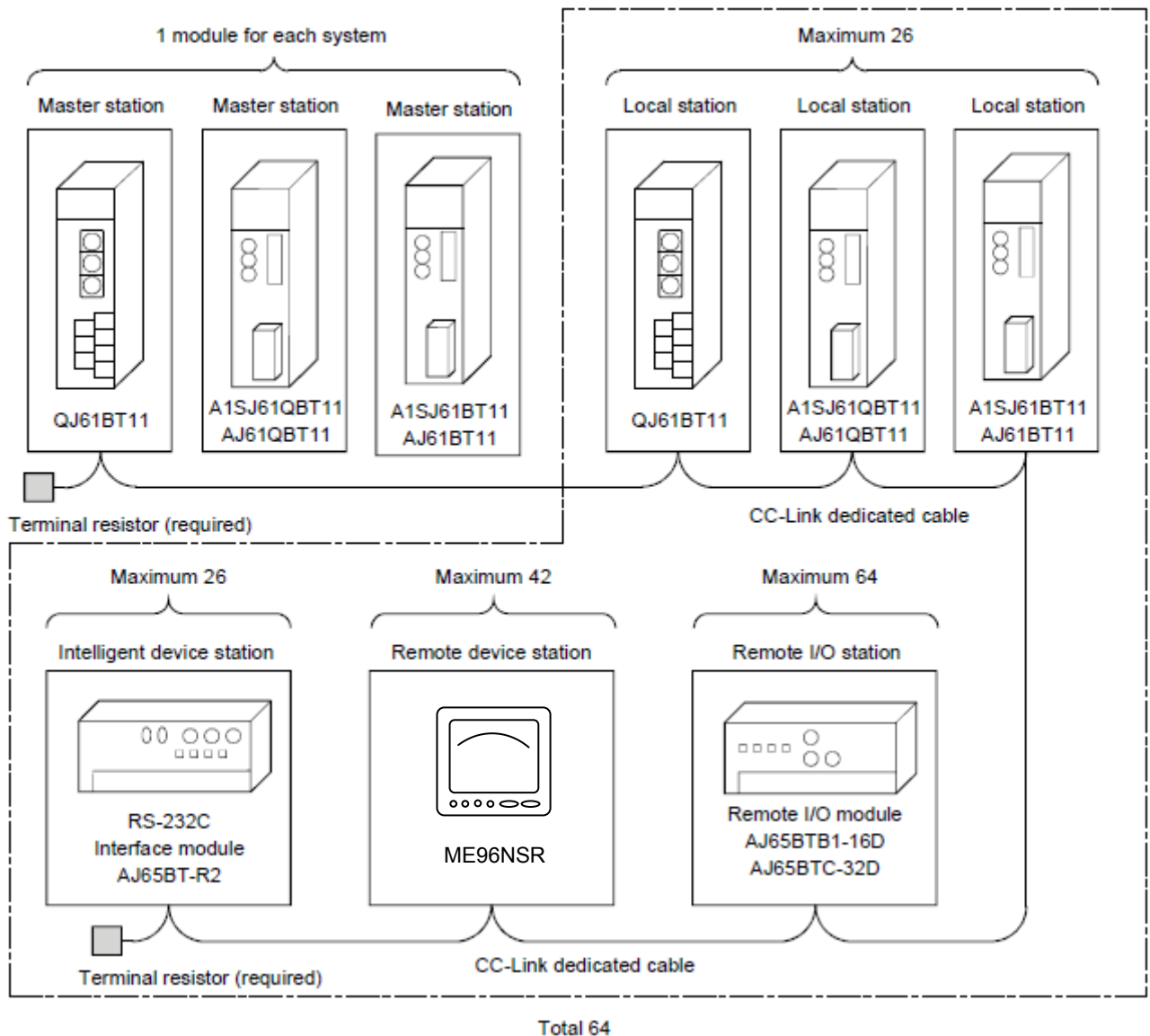

4. Parameter Settings

4.1 Procedure from Parameter Settings to Data Link Startup

The following explains the procedure from setting the parameters to stating the data link.

4.1.1 CPU Parameter Area and Master Module Parameter Memory

(1) CPU Parameter Area

This area is used to set the basic values for controlling the programmable controller system and the network parameters that control the CC-Link system.

(2) Master Station Parameter Memory

This area stores the network parameters for the CC-Link system.

When the module is powered OFF or the programmable controller CPU is reset, the network parameters are erased.

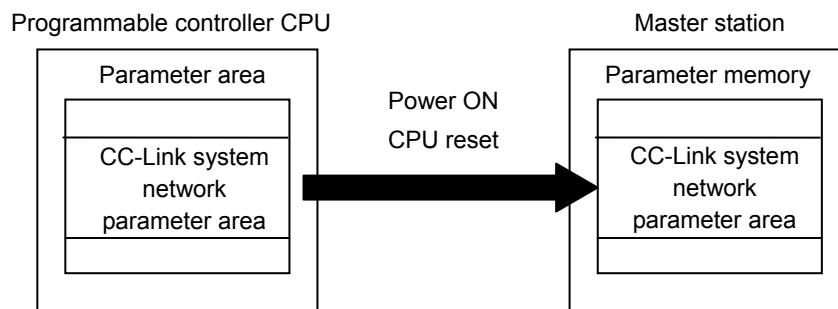

4.1.2 Procedure for Parameter Settings to Data Link Startup with GX Developer

Follow the procedure below for parameter settings to data link startup:

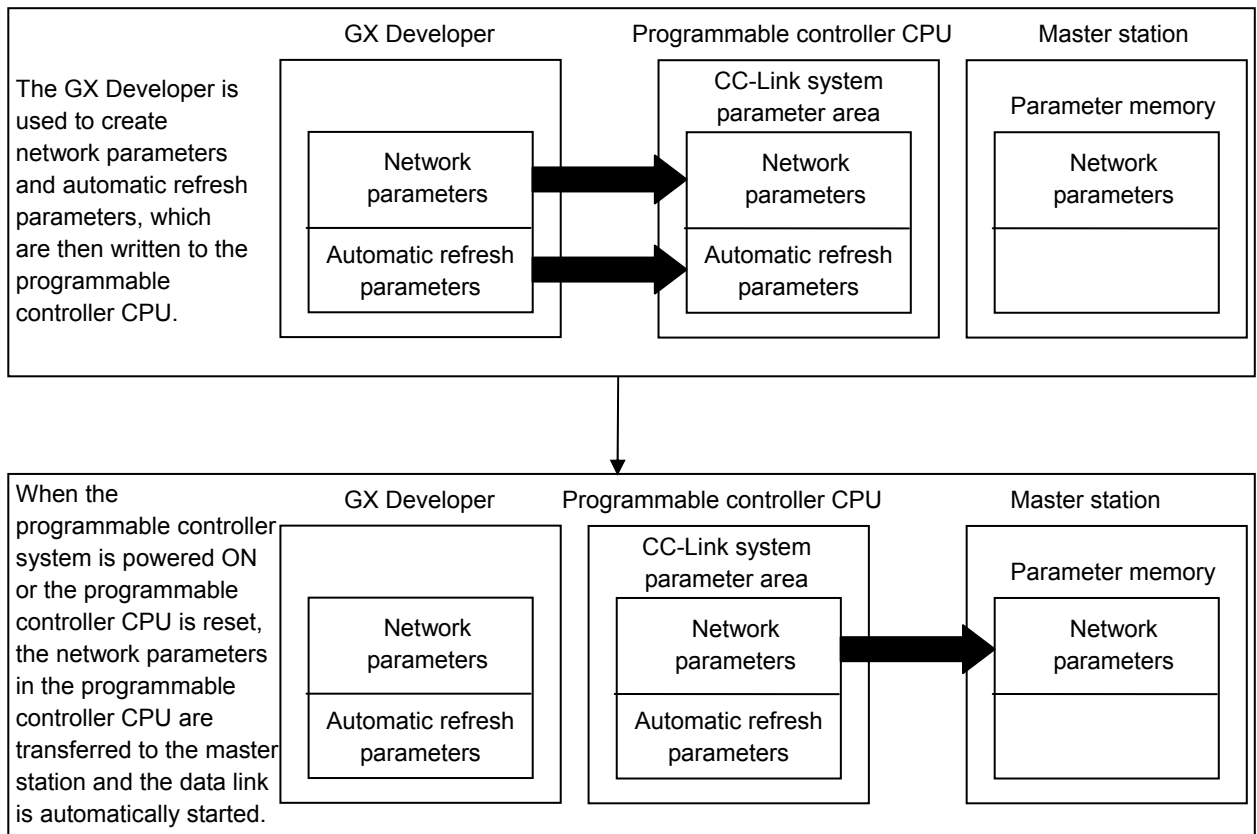

4.2 Parameter Setting Items

The following lists the items to be stored in the master station parameter memory.

Setting item	Description
Number of connected modules	Sets the total number of remote stations, local stations, intelligent device stations and standby master station that are connected to the master station (including reserved stations). Default value : 64 (modules) Setting range : 1 to 64 (modules)
Number of retries	Sets the number of retries when a communication error occurs. Default value : 3 (times) Setting range : 1 to 7 (times)
Number of automatic return modules	Sets the total number of remote stations, local stations, intelligent device stations and standby master stations that can be returned to system operation by a single link scan. Default value : 1 (module) Setting range : 1 to 10 (modules)
Standby master station specification	Specifies the station number of the standby master station. Default value : Blank (no standby master station specified) Setting range : Blank, 1 to 64 (Blank: No standby master station specified)
Operation specification when CPU is down	Specifies the data link status when a master station programmable controller CPU error occurs. Default value : Stop Setting range : Stop, Continue
Scan mode specification	Specifies either synchronous or asynchronous mode for sequence scan. Default value : Asynchronous Setting range : Asynchronous, Synchronous
Delay setting	Sets 0 for the delay time.
Reserved station specification	Specifies the reserved station. Default value : Not specified Setting range : Not specified, Specified
Error invalid station specification	Specifies the error invaled station. Default value : Not specified Setting range : Not specified, Specified
Station information	Sets the station information according to the connected remote station, local station, intelligent device station, and standby master station. Default value : Ver.1 remote I/O station, occupies 1 station, Station number 1 to Ver.1 remote I/O station, occupies 1 station, station number 64 Setting range station type : Remote I/O station, remote device station, intelligent device station/Ver.1, Ver.2 (single, double, quadruple, octuple) Number of occupied stations : 1 to 4 Station number : 1 to 64

4.3 Example of Parameter Settings with GX Developer

This section explains the parameter settings using the GX Developer. In the setting parameters used with GX Developer, the setting of master station network parameters and the setting of automatic refresh parameters are done. For more details on the GX Developer operation, refer to the GX Developer Operating Manual.

The explanations in this section are based on the following example of the system configuration.

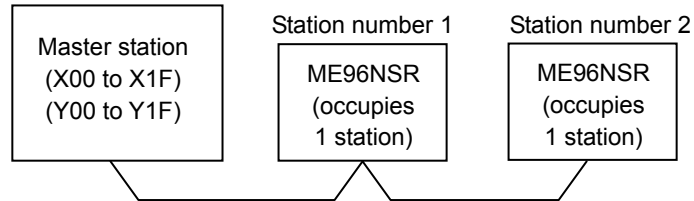

4.3.1 Master Station Network Parameter Settings

(1) The following describes an example of the parameter settings. See (2) for actual settings.

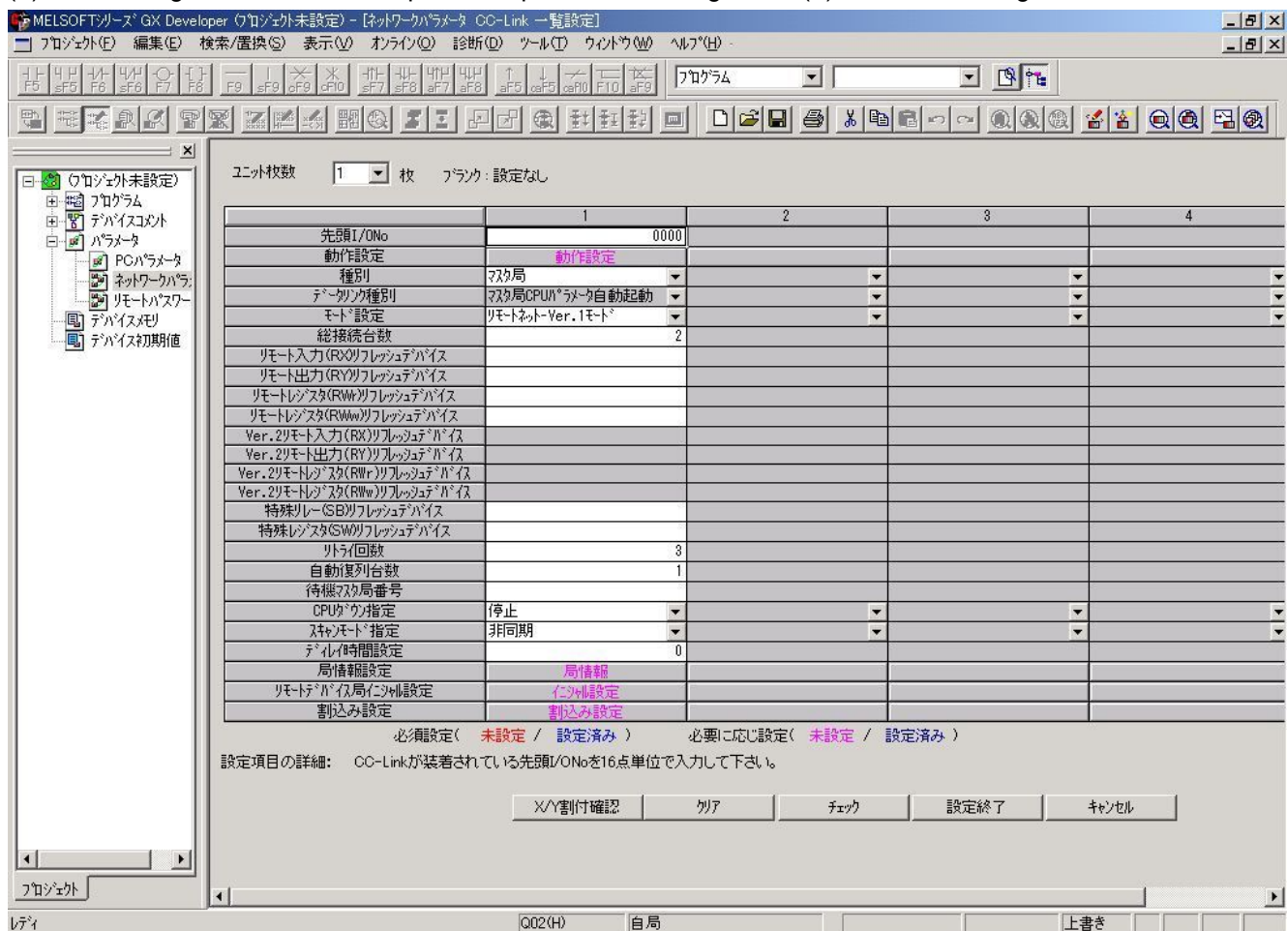

(2) Set the network parameters using the following procedure.

(a) Set the “No. of boards in module” for which the network parameters are to be set.

Default value : None

Setting range : 0~8 (Boards)

※Modules for the parameter setting with the G(P).RLPASET instruction should not be included in the setting for “No. of boards in module”.

Example) Set 1 (Board).

- (b) Set the “Start I/O No.” for the master station.

Default value : None

Setting range : 0000~0FE0

Example) Set 0000.

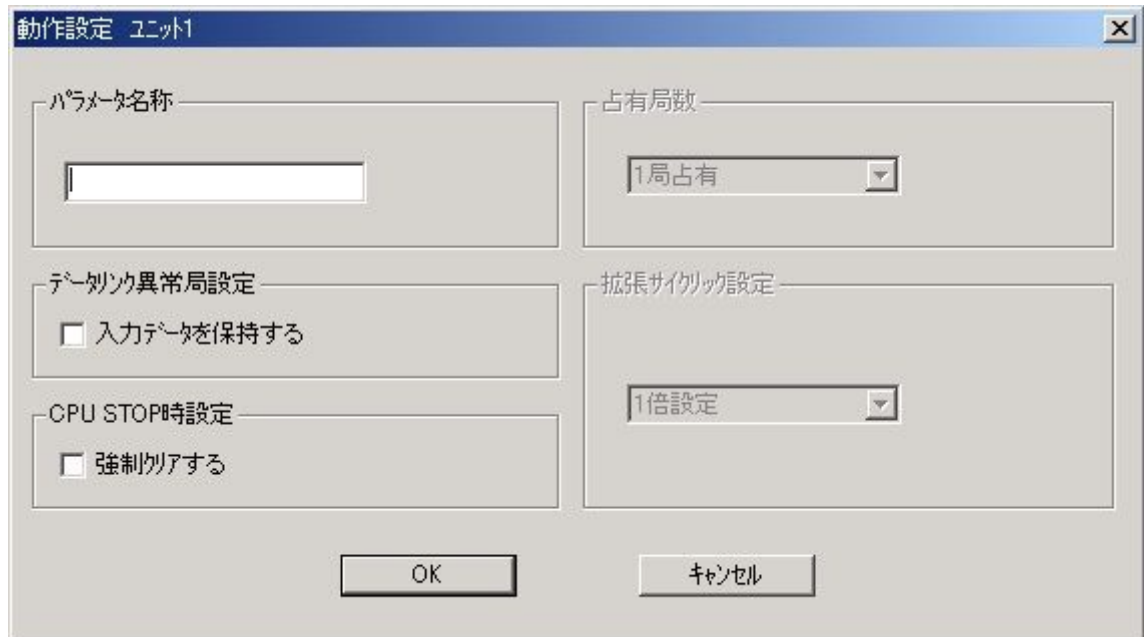

- (c) Set the Parameter name in “Operational Settings.”

Even if the Parameter name is not set, this will not affect the operation of the CC-Link system.

Default value : None

Setting range : 8 characters or less

Example) Set “None”.

- (d) Set the input status for the data link error station in “Operation settings”.

Default value : Clear (“Hold input data” not checked)

Setting range : Hold (“Hold input data” checked)

Clear (“Hold input data” not checked)

Example) Set to Clear (“Hold input data” not checked).

- (e) Set the slave station refresh/compulsory clear setting at programmable controller CPU STOP in “Operational settings”.

Default value : Refresh (“Clears compulsorily” not checked)

Setting range : Refresh (“Clears compulsorily” not checked)

Clears compulsorily (“Clears compulsorily” checked)

Example) Set to Refresh (“Clears compulsorily” not checked).

- (f) Set the station type for “Type”.

Default value : Master station

Setting range : Master station, Mastar station(Duplex function), Local station, Standby master station

Example) Set the Master station.

- (g) Set the CC-Link mode for “Mode”.
 Default value : Remote net (Ver.1 mode)
 Setting range : Remote net (Ver.1 mode), Remote net (Ver.2 mode), Remote net (Additional mode),
 Remote I/O net mode, Off line
 Example) Set to Remote net (Ver.1 mode).
- (h) Set the total number of connected stations in the CC-Link system including reserved stations for
 “All connect count”.
 Default value : 64 (modules)
 Setting range : 1 to 64 (modules)
 Example) Set to 2 (modules).
- (i) Set the number of retries for “Retry count”, when communication error occurs.
 Default value : 3 (times)
 Setting range : 1 to 7 (times)
 Example) Set to 3 (times).
- (j) Set the number of modules that can return to system operation by a single link scan for “Automatic
 reconnection station count”.
 Default value : 1 (module)
 Setting range : 1 to 10 (modules)
 Example) Set to 1 (module).
- (k) Set the station number for the standby master station for “Standby master station No.”.
 Default value : Blank (No standby master station specified)
 Setting range : Blank, 1 to 64 (Blank: No standby master station specified)
 Example) Set to Blank (No standby master station specified).
- (l) Set the data link status for “PLC down select”, when a master station programmable controller CPU
 error occurs.
 Default value : Stop
 Setting range : Stop, Continue
 Example) Set to Stop.
- (m) Set whether the link scan for the sequence scan is synchronous or asynchronous for “Scan mode
 setting”.
 Default value : Asynchronous
 Setting range : Asynchronous, Synchronous
 Example) Set to Asynchronous.
- (n) Set 0 for the delay time.

(o) Set the station data for “Station information settings”.

Default value : Remote I/O station, single, Occupies 1 station, 32 points, or no setting for reserved stations/error invalid.

Setting range : Station type - No setting

Remote I/O station

Remote device station

Intelligent device station

(including local station and standby master station)

Expanded cyclic setting (cannot be changed) -

single

Number of occupied stations -

No setting

Occupies 1 station

Occupies 2 stations

Occupies 3 stations

Occupies 4 stations

Remote station points (cannot be changed) -

32 points [when occupies 1 station]

64 points [when occupies 2 station]

96 points [when occupies 3 station]

128 points [when occupies 4 station]

Reserved/invalid station select -

No setting

Reserved station

Invalid station (error invalid station)

Intelligent buffer select -

No setting

Send 0, 64 to 4096

Receive 0, 64 to 4096

Automatic 0, 128 to 4096

Example) Set the station data according to the system configuration specified in Section 4.3.

As ME96NSR is remote device station, and the number of occupied stations is 1 station, it becomes the following.

台数/局番	局種別	拡張サイクル 設定	占有 局数	リモート局 点数	予約/無効局 指定	インテリジェント用バッファ指定(ワード)		
						送信	受信	自動
1/1	リモートデバイス局	1倍設定	1局占有	32点	設定なし			
2/2	リモートデバイス局	1倍設定	1局占有	32点	設定なし			

Default Check Setting Complete Cancel

4.3.2 Master Station Automatic Refresh Parameter Settings

(1) The following shows an example of the parameter settings. See (2) for actual settings.

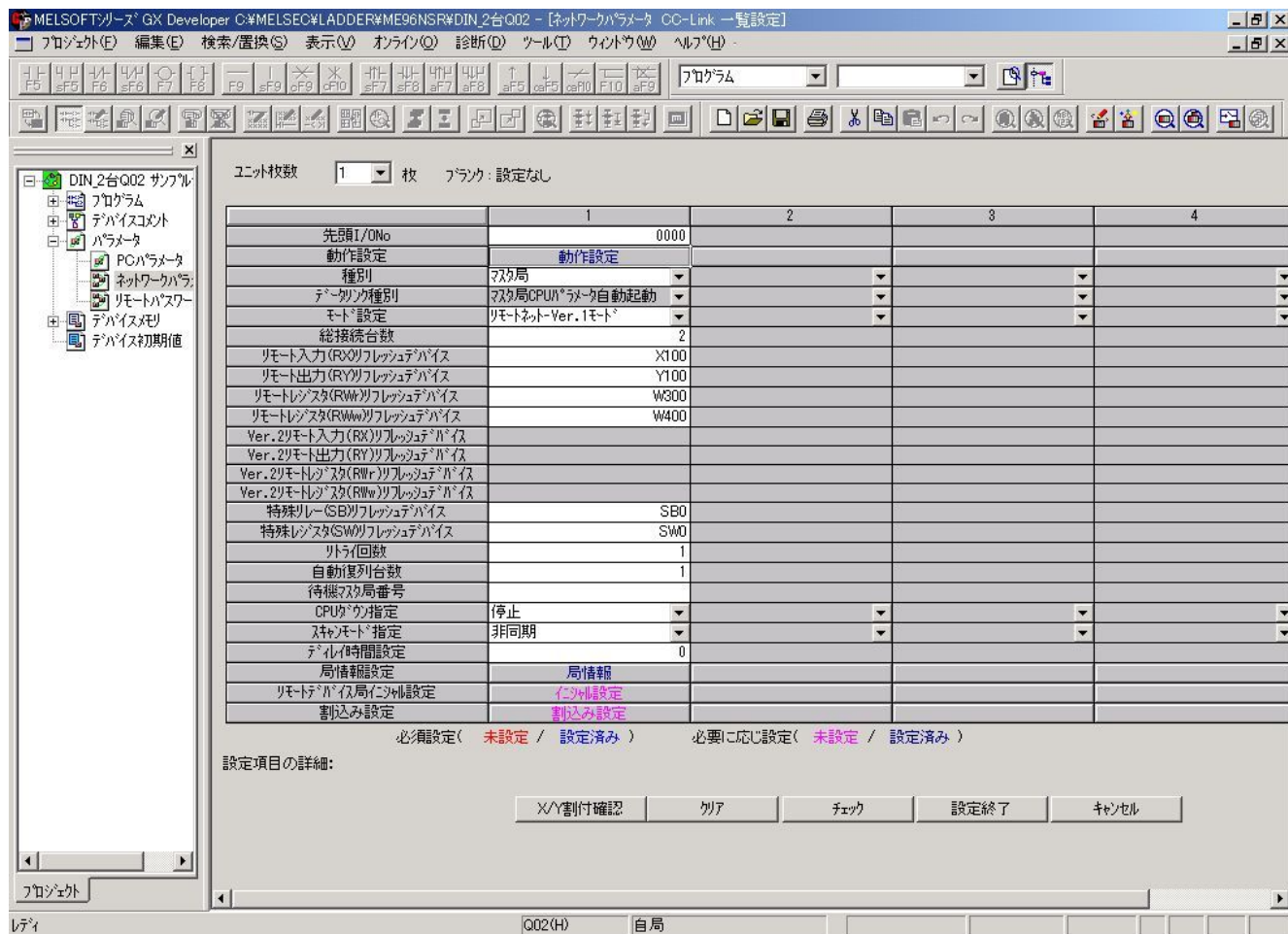

(2) Set the automatic refresh parameters using the following procedure.

- (a) Set the remote input (RX) refresh device for “Remote input (RX)”.
 - Default value : None
 - Setting range : Device name – Select from X, M, L, B, D, W, R or ZR.
 - Device number – Within the range of the device points that the CPU has.
 - Example) Set to X100
- (b) Set the remote output (RY) refresh device for “Remote output (RY)”.
 - Default value : None
 - Setting range : Device name – Select from Y, M, L, B, T, C, ST, D, W, R or ZR.
 - Device number – Within the range of the device points that the CPU has.
 - Example) Set to Y100.
- (c) Set the remote register (RWw) refresh device for “Remote register (RWw)”.
 - Default value : None
 - Setting range : Device name – Select from M, L, B, D, W, R or ZR.
 - Device number – Within the range of the device points that the CPU has.
 - Example) Set to W300.

- (d) Set the remote register (RWw) refresh device for “Remote register (RWw)”.
- Default value : None
- Setting range : Device name – Select from M, L, B, T, C, ST, D, W, R or ZR.
Device number – Within the range of the device points that the CPU has.
- Example) Set to W400.
- (e) Set the link special relay (SB) refresh device for “Special relay (SB)”.
- Default value : None
- Setting range : Device name – Select from M, L, B, D, W, R, SB or ZR.
Device number – Within the range of the device points that the CPU has.
- Example) Set to SB0.
- (f) Set the link special register (SW) refresh device for “Special register (SW)”.
- Default value : None
- Setting range : Device name – Select from M, L, B, D, W, R, SW or ZR.
Device number – Within the range of the device points that the CPU has.
- Example) Set to SW0.

POINT
<p>(1) For the automatic refresh parameter setting, set the start device only. Devices are automatically assigned until the last station number including reserved stations and occupied stations.</p> <p>(2) When setting X, Y, B, W, SB and SW as refresh devices, make setting so that they do not overlap with the device numbers used on the other networks, etc.</p>

5. Communication Between the Master Station and ME96NSR

5.1 Communication Guideline

There are three communication statuses (Initial Communication, Normal Communication, Error Communication) between the Master station and ME96NSR.

The following can be performed at normal communication.

- Monitoring of the measurement values such as the current, voltage and energy, etc.
- Monitoring of the bit data of the alarm state and the digital input state.
- Setting the set data of the time constant for current demand.

ME96NSR has a special-purpose command for each measurement items and each setting items. It becomes possible to monitor measurement value or to set the setting value by writing the command into the remote register RWw of the master station.

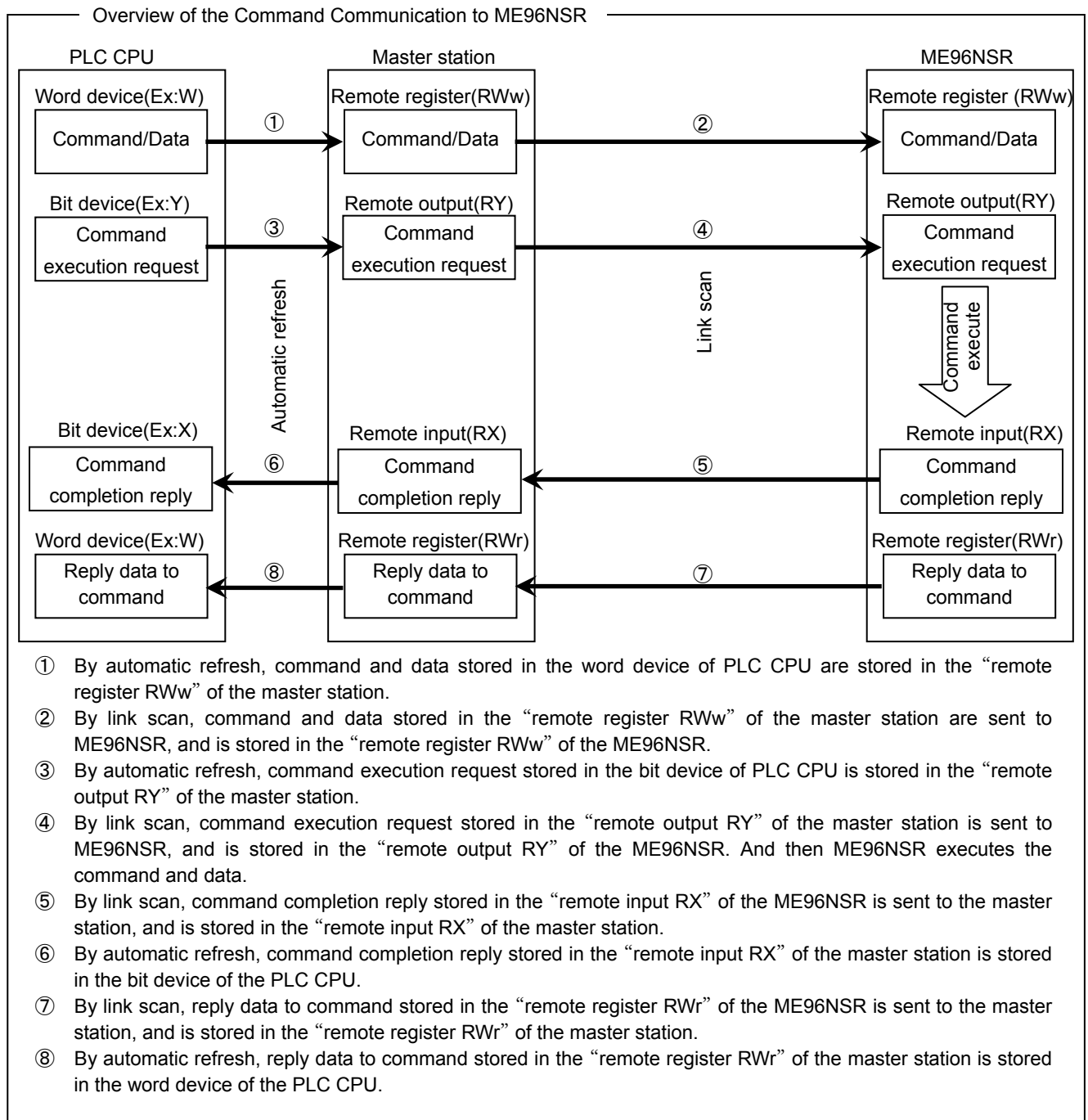

5.2 Initial Communication

Initial communication is performed at the beginning after the power supply is turned on or hardware is reset. Refer to section 6.1 about the remote input RX and the remote output RY.

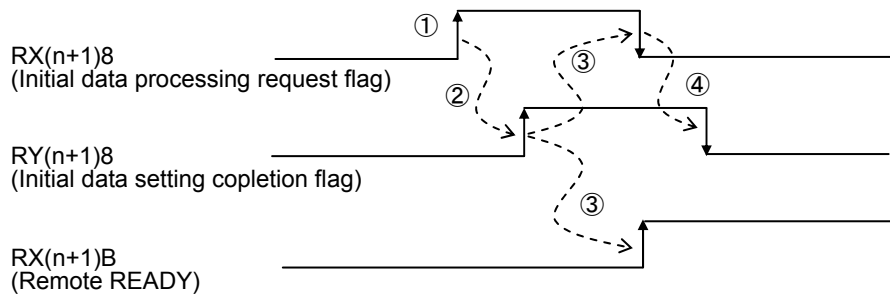

- ① After the power supply is turned on, or hardware is reset, the initial data processing request flag is turned on by ME96NSR.
- ② After the initial data processing request flag is turned on, turn on the initial data setting completion flag.
- ③ After the initial data setting completion flag is turned on, the initial data processing request flag is turned off and the remote READY is turned on.
- ④ After the initial data processing request flag is turned off, turned off the initial data setting completion flag.

5.3 Normal Communication

After initial data processing is complete, the normally communication is performed to monitor the measurement values and to set the parameters.

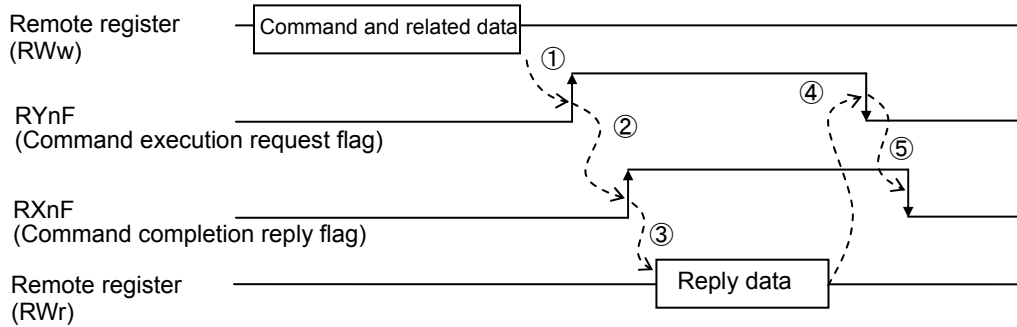

- ① After writing the command and related data into the remote register RWw, turn on the command execution request flag.
- ② After receiving the reply data corresponding to the command, the command completion reply flag turned on.
- ③ After the command completion reply flag is turned on, read the reply data from the remote register RWw.
- ④ After reading the reply data, cancel the command execution request by turning off the command execution request flag.
- ⑤ After the command execution request flag is turned off, the command completion reply flag is turned off.

Note: When sending commands successively, repeat ① to ⑤ above.
The command can be sent only when the remote READY is ON.

5.4 Error Communication

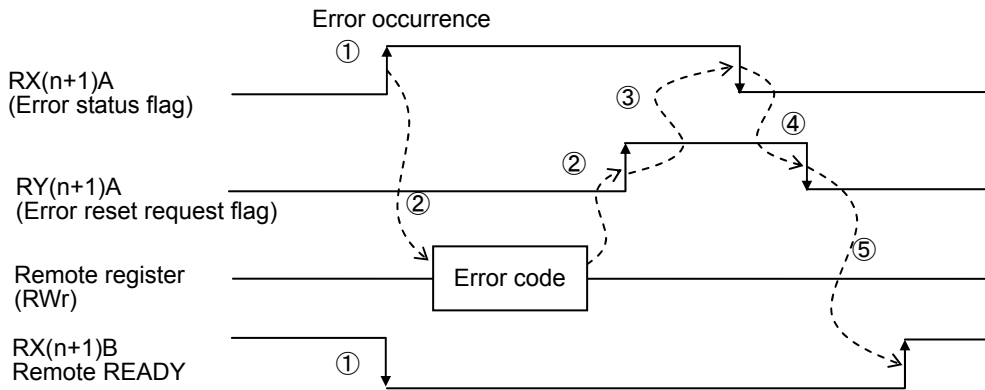

- ① When an error occurs in ME96NSR, error status flag is turned on and the remote READY is turned off.
- ② When the error status flag is turned on, read the error code from the remote register RWr. Eliminate the cause of the error while referring to the red error code. When resuming communication with ME96NSR, turn on the error reset request flag.
- ③ After the error reset request flag is turned on, the error status flag is turned off.
- ④ After the error status flag is turned off, turn off the error reset request flag.
- ⑤ After the error reset request flag is turned off, the remote READY is turned on and normal communication is resumed.

Note: Refer to "6.2.3 About error occurrence" for error code.

6. Remote I/O and Remote Register

6.1 Remote Input RX, Remote Output RY

The remote input RX and remote output RY are used to communicate for bit data between the master station and ME96NSR.

6.1.1 Remote input RX

The allocation of the remote input RX of ME96NSR is shown in the table below.

Device No.	Signal name	Description		Note
		OFF(0)	ON(1)	
RXn0	Digital input 1 (DI1)	OFF	ON	
RXn1	Digital input 2 (DI2)	OFF	ON	
RXn2	Digital input 3 (DI3)	OFF	ON	
RXn3	Digital input 4 (DI4)	OFF	ON	
RXn4	Unusable	—	—	
RXn5	Alarm (total)	Non-Alarm state	Alarm state	Note 2
RXn6	Alarm of Demand current	Non-Alarm state	Alarm state	Note 2
RXn7	Unusable	—	—	
RXn8	Alarm of Voltage	Non-Alarm state	Alarm state	Note 2
RXn9	Alarm of Current	Non-Alarm state	Alarm state	Note 2
RXnA	Alarm of Active power	Non-Alarm state	Alarm state	Note 2
RXnB	Alarm of Reactive power	Non-Alarm state	Alarm state	Note 2
RXnC	Alarm of Frequency	Non-Alarm state	Alarm state	Note 2
RXnD	Alarm of Power factor	Non-Alarm state	Alarm state	Note 2
RXnE	Alarm of T.H.D (Voltage)	Non-Alarm state	Alarm state	Note 2
RXnF	Command completion reply flag	No receiving of reply data	Receiving of reply data	Note 1, 4
RX(n+1)0	Unusable	—	—	
RX(n+1)1	Unusable	—	—	
RX(n+1)2	Unusable	—	—	
RX(n+1)3	Unusable	—	—	
RX(n+1)4	Unusable	—	—	
RX(n+1)5	Unusable	—	—	
RX(n+1)6	Unusable	—	—	
RX(n+1)7	Unusable	—	—	
RX(n+1)8	Initial data processing request flag	Power OFF, remote READY ON, or error status flag ON	Power supply is turned ON or hardware reset	Note 1
RX(n+1)9	Unusable	—	—	
RX(n+1)A	Error status flag	No error occurrence	Error occurrence	Note 1
RX(n+1)B	Remote READY	Command sending not possible	Normally communication status (Command sending possible)	Note 1
RX(n+1)C	Unusable	—	—	
RX(n+1)D	Unusable	—	—	
RX(n+1)E	Unusable	—	—	
RX(n+1)F	Unusable	—	—	

n: it can be obtained by converting “(station number -1)×2” to hexadecimal.

Note 1: For the details, refer to “5.Communication Between the Master Station and ME96NSR”

Note 2: “ON(1)” shows the state where the upper limit or the lower limit is exceeded.

Note 3: The number of alarms which can monitor are 4 items set up at ME96NSR.

Note 4: Alarm of harmonics current cannot be shown by remote input RX.

6.1.2 Remote Output RY

The allocation of the remote output RY of ME96NSR is shown in the table below.

Device No.	Signal name	Description		Note
		ON (1) → OFF (0)	OFF (0) → ON (1)	
RYn0	Unusable	—	—	
RYn1	Unusable	—	—	
RYn2	Unusable	—	—	
RYn3	Unusable	—	—	
RYn4	Unusable	—	—	
RYn5	Unusable	—	—	
RYn6	Unusable	—	—	
RYn7	Unusable	—	—	
RYn8	Unusable	—	—	
RYn9	Unusable	—	—	
RYnA	Unusable	—	—	
RYnB	Unusable	—	—	
RYnC	Unusable	—	—	
RYnD	Unusable	—	—	
RYnE	Unusable	—	—	
RYnF	Command execution request flag	Cancel command request	Command request	Note 1
RY(n+1)0	Unusable	—	—	
RY(n+1)1	Unusable	—	—	
RY(n+1)2	Unusable	—	—	
RY(n+1)3	Unusable	—	—	
RY(n+1)4	Unusable	—	—	
RY(n+1)5	Unusable	—	—	
RY(n+1)6	Unusable	—	—	
RY(n+1)7	Unusable	—	—	
RY(n+1)8	Initial data setting completion flag	Cancel normal communication request	Normal communication request	Note 1
RY(n+1)9	Unusable	—	—	
RY(n+1)A	Error reset request flag	Cancel error reset request	Error reset request	Note 1
RY(n+1)B	Unusable	—	—	
RY(n+1)C	Unusable	—	—	
RY(n+1)D	Unusable	—	—	
RY(n+1)E	Unusable	—	—	
RY(n+1)F	Unusable	—	—	

n: it can be obtained by converting “(station number -1)×2” to hexadecimal.

Note 1: For the details, refer to “5.Communication Between the Master Station and ME96NSR”

Point
Do not read or write to unusable remote registers. If reading or writing is performed, the functions of ME96NSR are not guaranteed.

6.2 Remote Register (RWr, RWw)

The remote register RWr and RWw are used to communicate word data between the master station and ME96NSR. Because it occupies 1 station, the remote registers RWr and RWw each have 4 words in length.

ME96NSR has the special-purpose commands for each measurement items and setting items. It becomes possible to monitor each measurement values or set each parameters by writing into the remote register RWw of the master station command and the related data allocated to the item you want to monitor or set.

6.2.1 Supported Command

The commands supported by ME96NSR are listed in the table below. For the details of each commands, refer to "6.2.2 Details of Commands".

Table 6.1 Supported Commands

Command	Name	Description	Note	page
1H	Data Monitor	For monitoring measurement		19
2H	Data Set	For setting measurement		31

Note) 1: The command can be sent only when the remote READY is ON.

2: The command execution request flag and command completion reply flag are used to send the command and receive replay data. For details of each flag, refer to "5.3 Normal Communication".

3: In case of monitoring the present value and its maximum continuously according to the renewal data timing of ME96NSR, the maximum may be smaller than the present value.

6.2.2 Details of Commands

The details of the command and reply data supported by ME96NSR are described here. How to view the details of each command described is the following page is shown below.

Command value	Command name	Description																																																							
1H	Data Monitor	<ul style="list-style-type: none"> After writing the command as shown below into the remote register RWwm, set the command execution request flag to ON(1). When the command completion reply flag turned on, the specified item is reset. The details of data written into the remote register RWwm are shown in the table below. 																																																							
Remote register RWwm (PLC→ME96NSR)		Remote register RWrn (ME96NSR→PLC)																																																							
<table border="1"> <tr> <td></td> <td>b15</td> <td>b8</td> <td>b7.....b4</td> <td>b3.....b0</td> <td></td> </tr> <tr> <td>m</td> <td colspan="2">Group No.</td> <td>Unit No.</td> <td>1H</td> <td>^{*1}1</td> </tr> <tr> <td>m+1</td> <td colspan="2">00H</td> <td colspan="2">Channel No.</td> <td></td> </tr> <tr> <td>m+2</td> <td colspan="2">00H</td> <td colspan="2">00H</td> <td></td> </tr> <tr> <td>m+3</td> <td colspan="2">00H</td> <td colspan="2">00H</td> <td></td> </tr> </table>			b15	b8	b7.....b4	b3.....b0		m	Group No.		Unit No.	1H	^{*1} 1	m+1	00H		Channel No.			m+2	00H		00H			m+3	00H		00H			<table border="1"> <tr> <td></td> <td>b15</td> <td>b8</td> <td>b7</td> <td>b0</td> </tr> <tr> <td>n</td> <td colspan="2">Channel No.</td> <td colspan="2">Group No.</td> </tr> <tr> <td>n+1</td> <td colspan="2">Index number</td> <td colspan="2">00H</td> </tr> <tr> <td>n+2</td> <td colspan="4">Low data</td> </tr> <tr> <td>n+3</td> <td colspan="4">High data</td> </tr> </table>		b15	b8	b7	b0	n	Channel No.		Group No.		n+1	Index number		00H		n+2	Low data				n+3	High data			
	b15	b8	b7.....b4	b3.....b0																																																					
m	Group No.		Unit No.	1H	^{*1} 1																																																				
m+1	00H		Channel No.																																																						
m+2	00H		00H																																																						
m+3	00H		00H																																																						
	b15	b8	b7	b0																																																					
n	Channel No.		Group No.																																																						
n+1	Index number		00H																																																						
n+2	Low data																																																								
n+3	High data																																																								

m, n: Address is allocated to the master module by the station number setting.

Contents of the register sent from the master station to the remote device station (ME96NSR). The command value should be stored in the 1st byte of the register to be transmitted. Because the length of transmission data is fixed to 4 words, 00H should be stored in areas in which no data is contained.

Contents of the register received by the master station from the remote device station (ME96NSR). Because the length of receive data is fixed to 4 words, 00H is stored in areas in which no reply data is contained.

*1: It is described as 8 bits data by combining the unit No. (high 4 bits) and the command (low 4 bits).

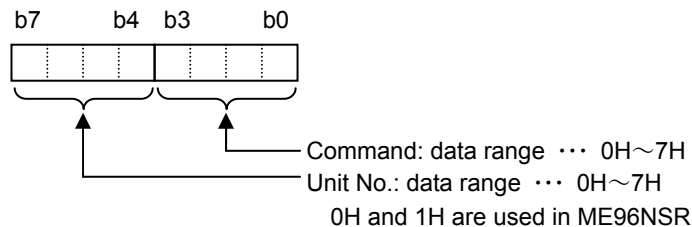

For example, When the unit No. is 0H and the command is 1H, it becomes "01H".

(1) Data Monitor Command (1H)

1H	Data Monitor	
<ul style="list-style-type: none"> • After writing the command as shown below into the remote register RWwm, set the command execution request flag to ON(1). When the command completion reply frag is turned on, the item specified is reset. • The details of the data written into the remote register RWwm are shown in the table Table 6.2 to Table 6.10. • The item can carry out monitor changes with phase and wiring types. (Refer to Table 6.2 to Table 6.4) 		
Remote register RWwm (PLC→ME96NSR)		Remote register RWrn (ME96NSR→PLC)
m	b15 b8 b7 b4 b3 b0	n
	Group No. Unit No. 1H	Channel No. Group No.
m+1	00H Channel No.	n+1
m+2	00H 00H	n+2
m+3	00H 00H	n+3
<p>(※) 0H and 1H is used in the unit No. of ME96NSR</p>		

m, n : Address is allocated to the master module by the station number setting.

Note: ME96NSR can monitor the data of the measurement item which is not displayed.

Table 6.2 Group Channel List (1/3)

Unit No.	Group (h)	Ch. (h)	Name of Channel	Data Type	Note	Unit No.	Group (h)	Ch. (h)	Name of Channel	Data Type	Note			
0	F0	2	Model code		⑤	0	3	1	Average L-N voltage	:V	Inst.	① *2		
0	E0	11	Primary current		④	0	3	21	1-N voltage	:V	Inst.	① *2		
0	E0	12	Primary voltage(L-L)		④	0	3	41	2-N voltage	:V	Inst.	① *2		
0	E0	1B	Primary voltage (L-N)		④	*2	0	3	61	3-N voltage	:V	Inst.	① *2	
0	E0	1C	Secondary voltage (L-N)		④		0	3	2	Average L-N voltage	:V	max.	① *2	
0	E0	13	Phase & Wiring		⑤		0	3	22	1-N voltage	:V	max.	① *2	
0	E0	18	Alarm Items		⑥		0	3	42	2-N voltage	:V	max.	① *2	
0	E0	19	Byte monitor		⑤		0	3	62	3-N voltage	:V	max.	① *2	
0	E0	1A	reserved				0	3	5	Average L-N voltage	:V	min.	① *2	
0	2	E0	Time constant for DA	:sec.	⑤		0	3	25	1-N voltage	:V	min.	① *2	
0	1	1	Average current	:A	Inst.	①	0	3	45	2-N voltage	:V	min.	① *2	
0	1	21	Phase 1 current	:A	Inst.	①	0	3	65	3-N voltage	:V	min.	① *2	
0	1	41	Phase 2 current	:A	Inst.	①	0	7	1	Total active power	:kW	Inst.	①	
0	1	61	Phase 3 current	:A	Inst.	①	0	7	21	Phase 1 active power	:kW	Inst.	① *2	
0	1	81	Phase N current	:A	Inst.	①	*2	0	7	41	Phase 2 active power	:kW	Inst.	① *2
0	1	2	Average current	:A	max.	①	0	7	61	Phase 3 active power	:kW	Inst.	① *2	
0	1	22	Phase 1 current	:A	max.	①	0	7	2	Total active power	:kW	max.	①	
0	1	42	Phase 2 current	:A	max.	①	0	7	22	Phase 1 active power	:kW	max.	① *2	
0	1	62	Phase 3 current	:A	max.	①	0	7	42	Phase 2 active power	:kW	max.	① *2	
0	1	82	Phase N current	:A	max.	①	*2	0	7	62	Phase 3 active power	:kW	max.	① *2
0	1	5	Average current	:A	min.	①	0	7	5	Total active power	:kW	min.	①	
0	1	25	Phase 1 current	:A	min.	①	0	7	25	Phase 1 active power	:kW	min.	① *2	
0	1	45	Phase 2 current	:A	min.	①	0	7	45	Phase 2 active power	:kW	min.	① *2	
0	1	65	Phase 3 current	:A	min.	①	0	7	65	Phase 3 active power	:kW	min.	① *2	
0	1	85	Phase N current	:A	min.	①	*2	0	9	1	Total reactive power	:kvar	Inst.	①
0	2	1	Average current demand	:A	Inst.	①	0	9	21	Phase 1 reactive power	:kvar	Inst.	① *2	
0	2	21	Phase 1 current demand	:A	Inst.	①	0	9	41	Phase 2 reactive power	:kvar	Inst.	① *2	
0	2	41	Phase 2 current demand	:A	Inst.	①	0	9	61	Phase 3 reactive power	:kvar	Inst.	① *2	
0	2	61	Phase 3 current demand	:A	Inst.	①	0	9	2	Total reactive power	:kvar	max.	①	
0	2	81	Phase N current demand	:A	Inst.	①	*2	0	9	22	Phase 1 reactive power	:kvar	max.	① *2
0	2	2	Average current demand	:A	max.	①	0	9	42	Phase 2 reactive power	:kvar	max.	① *2	
0	2	22	Phase 1 current demand	:A	max.	①	0	9	62	Phase 3 reactive power	:kvar	max.	① *2	
0	2	42	Phase 2 current demand	:A	max.	①	0	9	5	Total reactive power	:kvar	min.	①	
0	2	62	Phase 3 current demand	:A	max.	①	0	9	25	Phase 1 reactive power	:kvar	min.	① *2	
0	2	82	Phase N current demand	:A	max.	①	*2	0	9	45	Phase 2 reactive power	:kvar	min.	① *2
0	2	5	Average current demand	:A	min.	①	0	9	65	Phase 3 reactive power	:kvar	min.	① *2	
0	2	25	Phase 1 current demand	:A	min.	①	1	0B	1	Total apparent power	:kVA	Inst.	① *2	
0	2	45	Phase 2 current demand	:A	min.	①	1	0B	21	Phase 1 apparent power	:kVA	Inst.	① *2	
0	2	65	Phase 3 current demand	:A	min.	①	1	0B	41	Phase 2 apparent power	:kVA	Inst.	① *2	
0	2	85	Phase N current demand	:A	min.	①	*2	1	0B	61	Phase 3 apparent power	:kVA	Inst.	① *2
0	5	1	Average L-L voltage	:V	Inst.	①	1	0B	2	Total apparent power	:kVA	max.	① *2	
0	5	21	1-2 voltage	:V	Inst.	①	1	0B	22	Phase 1 apparent power	:kVA	max.	① *2	
0	5	41	2-3 voltage	:V	Inst.	①	1	0B	42	Phase 2 apparent power	:kVA	max.	① *2	
0	5	61	3-1 voltage	:V	Inst.	①	1	0B	62	Phase 3 apparent power	:kVA	max.	① *2	
0	5	2	Average L-L voltage	:V	max.	①	1	0B	5	Total apparent power	:kVA	min.	① *2	
0	5	22	1-2 voltage	:V	max.	①	1	0B	25	Phase 1 apparent power	:kVA	min.	① *2	
0	5	42	2-3 voltage	:V	max.	①	1	0B	45	Phase 2 apparent power	:kVA	min.	① *2	
0	5	62	3-1 voltage	:V	max.	①	1	0B	65	Phase 3 apparent power	:kVA	min.	① *2	
0	5	5	Average L-L voltage	:V	min.	①								
0	5	25	1-2 voltage	:V	min.	①								
0	5	45	2-3 voltage	:V	min.	①								
0	5	65	3-1 voltage	:V	min.	①								

* 1: Cannot be used by 3P4W.

* 2: Can only be used by 3P4W.

H.A: Current Harmonics

H.V: Voltage Harmonics

D.ratio: Distortion ratio

Inst.: Instantaneous value

Table 6.3 Group Channel List (2/3)

Unit No.	Group (h)	Ch. (h)	Name of Channel	Data Type	Note	Unit No.	Group (h)	Ch. (h)	Name of Channel	Data Type	Note						
0	0D	1	Total power factor	%	Inst.	①	0	4B	21	1-N H.V	V	Inst.	Total	①	*2		
0	0D	21	Phase 1 power factor	%	Inst.	①	*2	0	35	21	1-N H.V	V	Inst.	1st	①	*2	
0	0D	41	Phase 2 power factor	%	Inst.	①	*2	1	37	21	1-N H.V	V	Inst.	3rd	①	*2	
0	0D	61	Phase 3 power factor	%	Inst.	①	*2	1	39	21	1-N H.V	V	Inst.	5th	①	*2	
0	0D	2	Total power factor	%	max.	①		1	3B	21	1-N H.V	V	Inst.	7th	①	*2	
0	0D	22	Phase 1 power factor	%	max.	①	*2	1	3D	21	1-N H.V	V	Inst.	9th	①	*2	
0	0D	42	Phase 2 power factor	%	max.	①	*2	1	3F	21	1-N H.V	V	Inst.	11th	①	*2	
0	0D	62	Phase 3 power factor	%	max.	①	*2	1	41	21	1-N H.V	V	Inst.	13th	①	*2	
0	0D	5	Total power factor	%	min.	①		0	77	86	1-N H.V D. ratio	%	Inst.	Total	①	*2	
0	0D	25	Phase 1 power factor	%	min.	①	*2	0	77	73	1-N H.V D. ratio	%	Inst.	3rd	①	*2	
0	0D	45	Phase 2 power factor	%	min.	①	*2	0	77	75	1-N H.V D. ratio	%	Inst.	5th	①	*2	
0	0D	65	Phase 3 power factor	%	min.	①	*2	0	77	77	1-N H.V D. ratio	%	Inst.	7th	①	*2	
0	0F	1	Frequency	Hz	Inst.	①		0	77	79	1-N H.V D. ratio	%	Inst.	9th	①	*2	
0	0F	2	Frequency	Hz	max.	①		0	77	7B	1-N H.V D. ratio	%	Inst.	11th	①	*2	
0	0F	5	Frequency	Hz	min.	①		0	77	7D	1-N H.V D. ratio	%	Inst.	13th	①	*2	
0	63	21	1-2 H.V	V	Inst.	Total	①	*1	0	4B	41	2-N H.V	V	Inst.	Total	①	*2
0	4D	21	1-2 H.V	V	Inst.	1st	①	*1	0	35	41	2-N H.V	V	Inst.	1st	①	*2
0	4F	21	1-2 H.V	V	Inst.	3rd	①	*1	1	37	41	2-N H.V	V	Inst.	3rd	①	*2
0	51	21	1-2 H.V	V	Inst.	5th	①	*1	1	39	41	2-N H.V	V	Inst.	5th	①	*2
0	53	21	1-2 H.V	V	Inst.	7th	①	*1	1	3B	41	2-N H.V	V	Inst.	7th	①	*2
0	55	21	1-2 H.V	V	Inst.	9th	①	*1	1	3D	41	2-N H.V	V	Inst.	9th	①	*2
0	57	21	1-2 H.V	V	Inst.	11th	①	*1	1	3F	41	2-N H.V	V	Inst.	11th	①	*2
0	59	21	1-2 H.V	V	Inst.	13th	①	*1	1	41	41	2-N H.V	V	Inst.	13th	①	*2
0	76	86	1-2 H.V D. ratio	%	Inst.	Total	①	*1	0	77	9C	2-N H.V D. ratio	%	Inst.	Total	①	*2
0	76	73	1-2 H.V D. ratio	%	Inst.	3rd	①	*1	0	77	89	2-N H.V D. ratio	%	Inst.	3rd	①	*2
0	76	75	1-2 H.V D. ratio	%	Inst.	5th	①	*1	0	77	8B	2-N H.V D. ratio	%	Inst.	5th	①	*2
0	76	77	1-2 H.V D. ratio	%	Inst.	7th	①	*1	0	77	8D	2-N H.V D. ratio	%	Inst.	7th	①	*2
0	76	79	1-2 H.V D. ratio	%	Inst.	9th	①	*1	0	77	8F	2-N H.V D. ratio	%	Inst.	9th	①	*2
0	76	7B	1-2 H.V D. ratio	%	Inst.	11th	①	*1	0	77	91	2-N H.V D. ratio	%	Inst.	11th	①	*2
0	76	7D	1-2 H.V D. ratio	%	Inst.	13th	①	*1	0	77	93	2-N H.V D. ratio	%	Inst.	13th	①	*2
0	63	41	2-3 H.V	V	Inst.	Total	①	*1	0	4B	61	3-N H.V	V	Inst.	Total	①	*2
0	4D	41	2-3 H.V	V	Inst.	1st	①	*1	0	35	61	3-N H.V	V	Inst.	1st	①	*2
0	4F	41	2-3 H.V	V	Inst.	3rd	①	*1	1	37	61	3-N H.V	V	Inst.	3rd	①	*2
0	51	41	2-3 H.V	V	Inst.	5th	①	*1	1	39	61	3-N H.V	V	Inst.	5th	①	*2
0	53	41	2-3 H.V	V	Inst.	7th	①	*1	1	3B	61	3-N H.V	V	Inst.	7th	①	*2
0	55	41	2-3 H.V	V	Inst.	9th	①	*1	1	3D	61	3-N H.V	V	Inst.	9th	①	*2
0	57	41	2-3 H.V	V	Inst.	11th	①	*1	1	3F	61	3-N H.V	V	Inst.	11th	①	*2
0	59	41	2-3 H.V	V	Inst.	13th	①	*1	1	41	61	3-N H.V	V	Inst.	13th	①	*2
0	76	9C	2-3 H.V D. ratio	%	Inst.	Total	①	*1	0	77	B2	3-N H.V D. ratio	%	Inst.	Total	①	*2
0	76	89	2-3 H.V D. ratio	%	Inst.	3rd	①	*1	0	77	9F	3-N H.V D. ratio	%	Inst.	3rd	①	*2
0	76	8B	2-3 H.V D. ratio	%	Inst.	5th	①	*1	0	77	A1	3-N H.V D. ratio	%	Inst.	5th	①	*2
0	76	8D	2-3 H.V D. ratio	%	Inst.	7th	①	*1	0	77	A3	3-N H.V D. ratio	%	Inst.	7th	①	*2
0	76	8F	2-3 H.V D. ratio	%	Inst.	9th	①	*1	0	77	A5	3-N H.V D. ratio	%	Inst.	9th	①	*2
0	76	91	2-3 H.V D. ratio	%	Inst.	11th	①	*1	0	77	A7	3-N H.V D. ratio	%	Inst.	11th	①	*2
0	76	93	2-3 H.V D. ratio	%	Inst.	13th	①	*1	0	77	A9	3-N H.V D. ratio	%	Inst.	13th	①	*2
0	76	DE	L-L H.V D. ratio	%	max.	Total	①	*1	0	77	DE	L-N H.V D. ratio	%	max.	Total	①	*2
0	4D	A2	L-L H.V	V	max.	1st	①	*1	0	35	A2	L-N H.V	V	max.	1st	①	*2
0	76	CB	L-L H.V D. ratio	%	max.	3rd	①	*1	0	77	CB	L-N H.V D. ratio	%	max.	3rd	①	*2
0	76	CD	L-L H.V D. ratio	%	max.	5th	①	*1	0	77	CD	L-N H.V D. ratio	%	max.	5th	①	*2
0	76	CF	L-L H.V D. ratio	%	max.	7th	①	*1	0	77	CF	L-N H.V D. ratio	%	max.	7th	①	*2
0	76	D1	L-L H.V D. ratio	%	max.	9th	①	*1	0	77	D1	L-N H.V D. ratio	%	max.	9th	①	*2
0	76	D3	L-L H.V D. ratio	%	max.	11th	①	*1	0	77	D3	L-N H.V D. ratio	%	max.	11th	①	*2
0	76	D5	L-L H.V D. ratio	%	max.	13th	①	*1	0	77	D5	L-N H.V D. ratio	%	max.	13th	①	*2

* 1: Cannot be used by 3P4W.

* 2: Can only be used by 3P4W.

H.A: Current Harmonics

H.V: Voltage Harmonics

D.ratio: Distortion ratio

Inst.: Instantaneous value

Table 6.4 Group Channel List (3/3)

Unit No.	Group (h)	Ch. (h)	Name of Channel	Data Type	Note	Unit No.	Group (h)	Ch. (h)	Name of Channel	Data Type	Note			
0	33	21	Phase 1 H.A	A	Inst. Total	①	0	33	A2	H.A	A	max. Total	①	
0	1D	21	Phase 1 H.A	A	Inst. 1st	①	0	1D	A2	H.A	A	max. 1st	①	
0	1F	21	Phase 1 H.A	A	Inst. 3rd	①	0	1F	A2	H.A	A	max. 3rd	①	
0	21	21	Phase 1 H.A	A	Inst. 5th	①	0	21	A2	H.A	A	max. 5th	①	
0	23	21	Phase 1 H.A	A	Inst. 7th	①	0	23	A2	H.A	A	max. 7th	①	
0	25	21	Phase 1 H.A	A	Inst. 9th	①	0	25	A2	H.A	A	max. 9th	①	
0	27	21	Phase 1 H.A	A	Inst. 11th	①	0	27	A2	H.A	A	max. 11th	①	
0	29	21	Phase 1 H.A	A	Inst. 13th	①	0	29	A2	H.A	A	max. 13th	①	
0	75	86	Phase 1 H.A D. ratio	%	Inst. Total	①	1	33	82	Phase N H.A	A	max. Total	①	* 2
1	75	73	Phase 1 H.A D. ratio	%	Inst. 3rd	①	1	1D	82	Phase N H.A	A	max. 1st	①	* 2
1	75	75	Phase 1 H.A D. ratio	%	Inst. 5th	①	1	1F	82	Phase N H.A	A	max. 3rd	①	* 2
1	75	77	Phase 1 H.A D. ratio	%	Inst. 7th	①	1	21	82	Phase N H.A	A	max. 5th	①	* 2
1	75	79	Phase 1 H.A D. ratio	%	Inst. 9th	①	1	23	82	Phase N H.A	A	max. 7th	①	* 2
1	75	7B	Phase 1 H.A D. ratio	%	Inst. 11th	①	1	25	82	Phase N H.A	A	max. 9th	①	* 2
1	75	7D	Phase 1 H.A D. ratio	%	Inst. 13th	①	1	27	82	Phase N H.A	A	max. 11th	①	* 2
0	33	41	Phase 2 H.A	A	Inst. Total	①	1	29	82	Phase N H.A	A	max. 13th	①	* 2
0	1D	41	Phase 2 H.A	A	Inst. 1st	①	0	80	1	active energy import	kWh	count	②	
0	1F	41	Phase 2 H.A	A	Inst. 3rd	①	0	80	63	active energy export	kWh	count	②	
0	21	41	Phase 2 H.A	A	Inst. 5th	①	0	80	64	active energy import	kWh	count	expand ②	
0	23	41	Phase 2 H.A	A	Inst. 7th	①	0	80	65	active energy export	kWh	count	expand ②	
0	25	41	Phase 2 H.A	A	Inst. 9th	①	0	81	1	reactive energy import lag	kvar	count	②	
0	27	41	Phase 2 H.A	A	Inst. 11th	①	0	81	63	reactive energy export lag	kvar	count	②	
0	29	41	Phase 2 H.A	A	Inst. 13th	①	0	81	64	reactive energy import lead	kvar	count	②	
0	75	9C	Phase 2 H.A D. ratio	%	Inst. Total	①	0	81	65	reactive energy export lead	kvar	count	②	
1	75	89	Phase 2 H.A D. ratio	%	Inst. 3rd	①	0	81	66	reactive energy import lag	kvar	count	expand ②	
1	75	8B	Phase 2 H.A D. ratio	%	Inst. 5th	①	0	81	67	reactive energy export lag	kvar	count	expand ②	
1	75	8D	Phase 2 H.A D. ratio	%	Inst. 7th	①	0	81	68	reactive energy import lead	kvar	count	expand ②	
1	75	8F	Phase 2 H.A D. ratio	%	Inst. 9th	①	0	81	69	reactive energy export lead	kvar	count	expand ②	
1	75	91	Phase 2 H.A D. ratio	%	Inst. 11th	①	0	1	14	current upper limit	A	Alarm	①	
1	75	93	Phase 2 H.A D. ratio	%	Inst. 13th	①	0	1	15	current lower limit	A	Alarm	①	
0	33	61	Phase 3 H.A	A	Inst. Total	①	0	1	94	current upper limit	A	Alarm	PhaseN ①	* 2
0	1D	61	Phase 3 H.A	A	Inst. 1st	①	0	2	14	current demand upper limit	A	Alarm	①	
0	1F	61	Phase 3 H.A	A	Inst. 3rd	①	0	2	15	current demand lower limit	A	Alarm	①	
0	21	61	Phase 3 H.A	A	Inst. 5th	①	0	2	94	current demand upper limit	A	Alarm	PhaseN ①	* 2
0	23	61	Phase 3 H.A	A	Inst. 7th	①	0	5	14	voltage upper limit (L-L)	V	Alarm	①	
0	25	61	Phase 3 H.A	A	Inst. 9th	①	0	5	15	voltage lower limit (L-L)	V	Alarm	①	
0	27	61	Phase 3 H.A	A	Inst. 11th	①	0	3	14	voltage upper limit (L-N)	V	Alarm	①	* 2
0	29	61	Phase 3 H.A	A	Inst. 13th	①	0	3	15	voltage lower limit (L-N)	V	Alarm	①	* 2
0	75	B2	Phase 3 H.A D. ratio	%	Inst. Total	①	0	7	14	active power upper limit	kW	Alarm	①	
1	75	9F	Phase 3 H.A D. ratio	%	Inst. 3rd	①	0	7	15	active power lower limit	kW	Alarm	①	
1	75	A1	Phase 3 H.A D. ratio	%	Inst. 5th	①	0	9	14	reactive power upper limit	kvar	Alarm	①	
1	75	A3	Phase 3 H.A D. ratio	%	Inst. 7th	①	0	9	15	reactive power lower limit	kvar	Alarm	①	
1	75	A5	Phase 3 H.A D. ratio	%	Inst. 9th	①	0	0D	14	power factor upper limit	%	Alarm	①	
1	75	A7	Phase 3 H.A D. ratio	%	Inst. 11th	①	0	0D	15	power factor lower limit	%	Alarm	①	
1	75	A9	Phase 3 H.A D. ratio	%	Inst. 13th	①	0	0F	14	Frequency upper limit	Hz	Alarm	①	
0	33	81	Phase N H.A	A	Inst. Total	①	0	0F	15	Frequency lower limit	Hz	Alarm	①	
0	1D	81	Phase N H.A	A	Inst. 1st	①	0	77	E1	H.V(L-N) upper limit	%	Alarm	Total ①	* 2
0	1F	81	Phase N H.A	A	Inst. 3rd	①	0	76	E1	H.V(L-L) upper limit	%	Alarm	Total ①	* 1
0	21	81	Phase N H.A	A	Inst. 5th	①	0	75	E1	H.A upper limit	A	Alarm	Total ①	
0	23	81	Phase N H.A	A	Inst. 7th	①	0	75	F1	H.A upper limit(Phase N)	A	Alarm	Total ①	* 2
0	25	81	Phase N H.A	A	Inst. 9th	①	0	A0	31	Alarm state		Alarm	③	
0	27	81	Phase N H.A	A	Inst. 11th	①	0	A0	35	Alarm state2		Alarm	③	
0	29	81	Phase N H.A	A	Inst. 13th	①								
0	75	C8	Phase N H.A D. ratio	%	Inst. Total	①								* 2
1	75	B5	Phase N H.A D. ratio	%	Inst. 3rd	①								* 2
1	75	B7	Phase N H.A D. ratio	%	Inst. 5th	①								* 2
1	75	B9	Phase N H.A D. ratio	%	Inst. 7th	①								* 2
1	75	BB	Phase N H.A D. ratio	%	Inst. 9th	①								* 2
1	75	BD	Phase N H.A D. ratio	%	Inst. 11th	①								* 2
1	75	BF	Phase N H.A D. ratio	%	Inst. 13th	①								* 2

* 1: Cannot be used by 3P4W.

* 2: Can only be used by 3P4W.

H.A: Current Harmonics

H.V: Voltage Harmonics

D.ratio: Distortion ratio

Inst.: Instantaneous value

Table 6.5 Data Format (1/6)

Data	Data Format ①																				
<p>Measurement Items</p> <p>Current, Voltage, Active power, Reactive power, Apparent power, Power factor, Frequency, etc.</p>	 <p>Index number: b7, b0</p> <p>High data: b31, b24, b23, b16</p> <p>Low data: b15, b8, b7, b0</p> <p>Multiplicand</p> <p>Numeric value: 32-bit integer with a sign -2147483648 ~ 2147483647 (80000000H ~ 7FFFFFFFH)</p>																				
<p>Format①</p>	<p>< Multiplicand ></p> <p>Multiplicand is fixed for every item according to primary current, primary voltage, and phase wiring. (Refer to p. 30.)</p>																				
	<p>Index number = 03H: The actual value is 1000 times the numeric value.</p> <p>Index number = 02H: The actual value is 100 times the numeric value.</p> <p>Index number = 01H: The actual value is 10 times the numeric value.</p> <p>Index number = 00H: The actual value is the numeric value.</p> <p>Index number = FFH: The actual value is 1/10 times the numeric value.</p> <p>Index number = FEH: The actual value is 1/100 times the numeric value.</p> <p>Index number = FDH: The actual value is 1/1000 times the numeric value.</p>																				
	<p>< Example: Active power ></p> <table border="1" data-bbox="422 1220 1452 1467"> <thead> <tr> <th>Data</th> <th>Multiplicand</th> <th>Numeric value</th> <th>Actual value</th> </tr> </thead> <tbody> <tr> <td>FF000000FFH</td> <td>FFH⇒1/10</td> <td>000000FFH⇒255</td> <td>255×1/10 = 25.5[kW]</td> </tr> <tr> <td>00000000FFH</td> <td>00H⇒1</td> <td>000000FFH⇒255</td> <td>255×1 = 255[kW]</td> </tr> <tr> <td>FFFFFFFF01H</td> <td>FFH⇒1/10</td> <td>FFFFFFFF01H⇒-255</td> <td>-255×1/10 = -25.5[kW]</td> </tr> <tr> <td>00FFFFFFFF01H</td> <td>00H⇒1</td> <td>FFFFFFFF01H⇒-255</td> <td>-255×1 = -255[kW]</td> </tr> </tbody> </table>	Data	Multiplicand	Numeric value	Actual value	FF000000FFH	FFH⇒1/10	000000FFH⇒255	255×1/10 = 25.5[kW]	00000000FFH	00H⇒1	000000FFH⇒255	255×1 = 255[kW]	FFFFFFFF01H	FFH⇒1/10	FFFFFFFF01H⇒-255	-255×1/10 = -25.5[kW]	00FFFFFFFF01H	00H⇒1	FFFFFFFF01H⇒-255	-255×1 = -255[kW]
Data	Multiplicand	Numeric value	Actual value																		
FF000000FFH	FFH⇒1/10	000000FFH⇒255	255×1/10 = 25.5[kW]																		
00000000FFH	00H⇒1	000000FFH⇒255	255×1 = 255[kW]																		
FFFFFFFF01H	FFH⇒1/10	FFFFFFFF01H⇒-255	-255×1/10 = -25.5[kW]																		
00FFFFFFFF01H	00H⇒1	FFFFFFFF01H⇒-255	-255×1 = -255[kW]																		
	<p>Note: When the elements are active power and reactive power in case of a data monitor, ±1638.3MW becomes the upper(lower) value.</p>																				

Table 6.6 Data Format (2/6)

Data	Data Format ②												
<p>Measurement Items</p> <p>Active energy</p> <p>Reactive energy</p> <p>Format②</p>	<div style="text-align: center;">  </div> <p>< Multiplicand ></p> <p>Multiplicand is fixed for every item according to primary current, primary voltage, and phase wiring. (Refer to p. 30.)</p> <p>Index number = 03H: The actual value is 1000 times the numeric value. Index number = 02H: The actual value is 100 times the numeric value. Index number = 01H: The actual value is 10 times the numeric value. Index number = 00H: The actual value is the numeric value. Index number = FFH: The actual value is 1/10 times the numeric value. Index number = FEH: The actual value is 1/100 times the numeric value. Index number = FDH: The actual value is 1/1000 times the numeric value. Index number = FCH: The actual value is 1/10000 times the numeric value. Index number = FBH: The actual value is 1/100000 times the numeric value.</p> <p>< Example: Active Energy ></p> <table border="1" data-bbox="422 1310 1460 1467"> <thead> <tr> <th>Data</th> <th>Multiplicand</th> <th>Numeric value</th> <th>Actual value</th> </tr> </thead> <tbody> <tr> <td>FF000000FFH</td> <td>FFH⇒1/10</td> <td>000000FFH⇒255</td> <td>255×1/10 = 25.5[kWh]</td> </tr> <tr> <td>00000000FFH</td> <td>00H⇒1</td> <td>000000FFH⇒255</td> <td>255×1 = 255[kWh]</td> </tr> </tbody> </table>	Data	Multiplicand	Numeric value	Actual value	FF000000FFH	FFH⇒1/10	000000FFH⇒255	255×1/10 = 25.5[kWh]	00000000FFH	00H⇒1	000000FFH⇒255	255×1 = 255[kWh]
Data	Multiplicand	Numeric value	Actual value										
FF000000FFH	FFH⇒1/10	000000FFH⇒255	255×1/10 = 25.5[kWh]										
00000000FFH	00H⇒1	000000FFH⇒255	255×1 = 255[kWh]										

Table 6.7 Data Format (3/6)

Data	Data Format ③																																																																										
Alarm state	<div style="display: flex; justify-content: space-around; align-items: flex-start;"> <div style="text-align: center;"> <p>Index number</p> <p>b7 b0</p>  <p>Multiplicand (=00H (fixed))</p> </div> <div style="text-align: center;"> <p>High data</p> <p>b31 b24 b23 b16</p>  <p>Alarm state</p> </div> <div style="text-align: center;"> <p>Low data</p> <p>b15 b8 b7 b0</p>  <p>Unused (=0000H (fixed))</p> </div> </div>																																																																										
Format③																																																																											
	< The allocation of the alarm state 1 >																																																																										
	<table border="1" style="width: 100%; border-collapse: collapse;"> <thead> <tr> <th rowspan="2">Bit</th> <th colspan="3">Data</th> </tr> <tr> <th>Content</th> <th>OFF(0)</th> <th>ON(1)</th> </tr> </thead> <tbody> <tr><td>b16</td><td>Digital input 1 (DI1)</td><td>OFF</td><td>ON</td></tr> <tr><td>b17</td><td>Digital input 2 (DI2)</td><td>OFF</td><td>ON</td></tr> <tr><td>b18</td><td>Digital input 3 (DI3)</td><td>OFF</td><td>ON</td></tr> <tr><td>b19</td><td>Digital input 4 (DI4)</td><td>OFF</td><td>ON</td></tr> <tr><td>b20</td><td>Unusable</td><td>-</td><td>-</td></tr> <tr><td>b21</td><td>Alarm (total)</td><td>Non-Alarm</td><td>Alarm</td></tr> <tr><td>b22</td><td>Alarm of Demand current (*1)</td><td>Non-Alarm</td><td>Alarm</td></tr> <tr><td>b23</td><td>Unusable</td><td>-</td><td>-</td></tr> <tr><td>b24</td><td>Alarm of Voltage (*1)</td><td>Non-Alarm</td><td>Alarm</td></tr> <tr><td>b25</td><td>Alarm of Current (*1)</td><td>Non-Alarm</td><td>Alarm</td></tr> <tr><td>b26</td><td>Alarm of Active power (*1)</td><td>Non-Alarm</td><td>Alarm</td></tr> <tr><td>b27</td><td>Alarm of Reactive power (*1)</td><td>Non-Alarm</td><td>Alarm</td></tr> <tr><td>b28</td><td>Alarm of Frequency</td><td>Non-Alarm</td><td>Alarm</td></tr> <tr><td>b29</td><td>Alarm of Power factor (*1)</td><td>Non-Alarm</td><td>Alarm</td></tr> <tr><td>b30</td><td>Alarm of T.H.D(Voltage) (*1)</td><td>Non-Alarm</td><td>Alarm</td></tr> <tr><td>b31</td><td>Alarm of Harmonics current (*1)</td><td>Non-Alarm</td><td>Alarm</td></tr> </tbody> </table>				Bit	Data			Content	OFF(0)	ON(1)	b16	Digital input 1 (DI1)	OFF	ON	b17	Digital input 2 (DI2)	OFF	ON	b18	Digital input 3 (DI3)	OFF	ON	b19	Digital input 4 (DI4)	OFF	ON	b20	Unusable	-	-	b21	Alarm (total)	Non-Alarm	Alarm	b22	Alarm of Demand current (*1)	Non-Alarm	Alarm	b23	Unusable	-	-	b24	Alarm of Voltage (*1)	Non-Alarm	Alarm	b25	Alarm of Current (*1)	Non-Alarm	Alarm	b26	Alarm of Active power (*1)	Non-Alarm	Alarm	b27	Alarm of Reactive power (*1)	Non-Alarm	Alarm	b28	Alarm of Frequency	Non-Alarm	Alarm	b29	Alarm of Power factor (*1)	Non-Alarm	Alarm	b30	Alarm of T.H.D(Voltage) (*1)	Non-Alarm	Alarm	b31	Alarm of Harmonics current (*1)	Non-Alarm	Alarm
Bit	Data																																																																										
	Content	OFF(0)	ON(1)																																																																								
b16	Digital input 1 (DI1)	OFF	ON																																																																								
b17	Digital input 2 (DI2)	OFF	ON																																																																								
b18	Digital input 3 (DI3)	OFF	ON																																																																								
b19	Digital input 4 (DI4)	OFF	ON																																																																								
b20	Unusable	-	-																																																																								
b21	Alarm (total)	Non-Alarm	Alarm																																																																								
b22	Alarm of Demand current (*1)	Non-Alarm	Alarm																																																																								
b23	Unusable	-	-																																																																								
b24	Alarm of Voltage (*1)	Non-Alarm	Alarm																																																																								
b25	Alarm of Current (*1)	Non-Alarm	Alarm																																																																								
b26	Alarm of Active power (*1)	Non-Alarm	Alarm																																																																								
b27	Alarm of Reactive power (*1)	Non-Alarm	Alarm																																																																								
b28	Alarm of Frequency	Non-Alarm	Alarm																																																																								
b29	Alarm of Power factor (*1)	Non-Alarm	Alarm																																																																								
b30	Alarm of T.H.D(Voltage) (*1)	Non-Alarm	Alarm																																																																								
b31	Alarm of Harmonics current (*1)	Non-Alarm	Alarm																																																																								
	*1: As for the alarm judging items, refer to next page.																																																																										
	< The allocation of the alarm state 2 >																																																																										
	<table border="1" style="width: 100%; border-collapse: collapse;"> <thead> <tr> <th rowspan="2">Bit</th> <th colspan="3">Data</th> </tr> <tr> <th>Content</th> <th>OFF(0)</th> <th>ON(1)</th> </tr> </thead> <tbody> <tr><td>b16</td><td>Upper limit alarm of current (phase 1)</td><td>Non-Alarm</td><td>Alarm</td></tr> <tr><td>b17</td><td>Upper limit alarm of current (phase 2)</td><td>Non-Alarm</td><td>Alarm</td></tr> <tr><td>b18</td><td>Upper limit alarm of current (phase 3)</td><td>Non-Alarm</td><td>Alarm</td></tr> <tr><td>b19</td><td>Upper limit alarm of current (phase N)</td><td>Non-Alarm</td><td>Alarm</td></tr> <tr><td>b20</td><td>Upper limit alarm of current (total) (*2)</td><td>Non-Alarm</td><td>Alarm</td></tr> <tr><td>b21</td><td>Lower limit alarm of current (total) (*2)</td><td>Non-Alarm</td><td>Alarm</td></tr> <tr><td>b22</td><td>Upper limit alarm of L-L Voltage (total)</td><td>Non-Alarm</td><td>Alarm</td></tr> <tr><td>b23</td><td>Lower limit alarm of L-L Voltage (total)</td><td>Non-Alarm</td><td>Alarm</td></tr> <tr><td>b24</td><td>Upper limit alarm of L-N Voltage (1-N)</td><td>Non-Alarm</td><td>Alarm</td></tr> <tr><td>b25</td><td>Upper limit alarm of L-N Voltage (2-N)</td><td>Non-Alarm</td><td>Alarm</td></tr> <tr><td>b26</td><td>Upper limit alarm of L-N Voltage (3-N)</td><td>Non-Alarm</td><td>Alarm</td></tr> <tr><td>b27</td><td>Upper limit alarm of L-N Voltage (total)</td><td>Non-Alarm</td><td>Alarm</td></tr> <tr><td>b28</td><td>Lower limit alarm of L-N Voltage (1-N)</td><td>Non-Alarm</td><td>Alarm</td></tr> <tr><td>b29</td><td>Lower limit alarm of L-N Voltage (2-N)</td><td>Non-Alarm</td><td>Alarm</td></tr> <tr><td>b30</td><td>Lower limit alarm of L-N Voltage (3-N)</td><td>Non-Alarm</td><td>Alarm</td></tr> <tr><td>b31</td><td>Lower limit alarm of L-N Voltage (total)</td><td>Non-Alarm</td><td>Alarm</td></tr> </tbody> </table>				Bit	Data			Content	OFF(0)	ON(1)	b16	Upper limit alarm of current (phase 1)	Non-Alarm	Alarm	b17	Upper limit alarm of current (phase 2)	Non-Alarm	Alarm	b18	Upper limit alarm of current (phase 3)	Non-Alarm	Alarm	b19	Upper limit alarm of current (phase N)	Non-Alarm	Alarm	b20	Upper limit alarm of current (total) (*2)	Non-Alarm	Alarm	b21	Lower limit alarm of current (total) (*2)	Non-Alarm	Alarm	b22	Upper limit alarm of L-L Voltage (total)	Non-Alarm	Alarm	b23	Lower limit alarm of L-L Voltage (total)	Non-Alarm	Alarm	b24	Upper limit alarm of L-N Voltage (1-N)	Non-Alarm	Alarm	b25	Upper limit alarm of L-N Voltage (2-N)	Non-Alarm	Alarm	b26	Upper limit alarm of L-N Voltage (3-N)	Non-Alarm	Alarm	b27	Upper limit alarm of L-N Voltage (total)	Non-Alarm	Alarm	b28	Lower limit alarm of L-N Voltage (1-N)	Non-Alarm	Alarm	b29	Lower limit alarm of L-N Voltage (2-N)	Non-Alarm	Alarm	b30	Lower limit alarm of L-N Voltage (3-N)	Non-Alarm	Alarm	b31	Lower limit alarm of L-N Voltage (total)	Non-Alarm	Alarm
Bit	Data																																																																										
	Content	OFF(0)	ON(1)																																																																								
b16	Upper limit alarm of current (phase 1)	Non-Alarm	Alarm																																																																								
b17	Upper limit alarm of current (phase 2)	Non-Alarm	Alarm																																																																								
b18	Upper limit alarm of current (phase 3)	Non-Alarm	Alarm																																																																								
b19	Upper limit alarm of current (phase N)	Non-Alarm	Alarm																																																																								
b20	Upper limit alarm of current (total) (*2)	Non-Alarm	Alarm																																																																								
b21	Lower limit alarm of current (total) (*2)	Non-Alarm	Alarm																																																																								
b22	Upper limit alarm of L-L Voltage (total)	Non-Alarm	Alarm																																																																								
b23	Lower limit alarm of L-L Voltage (total)	Non-Alarm	Alarm																																																																								
b24	Upper limit alarm of L-N Voltage (1-N)	Non-Alarm	Alarm																																																																								
b25	Upper limit alarm of L-N Voltage (2-N)	Non-Alarm	Alarm																																																																								
b26	Upper limit alarm of L-N Voltage (3-N)	Non-Alarm	Alarm																																																																								
b27	Upper limit alarm of L-N Voltage (total)	Non-Alarm	Alarm																																																																								
b28	Lower limit alarm of L-N Voltage (1-N)	Non-Alarm	Alarm																																																																								
b29	Lower limit alarm of L-N Voltage (2-N)	Non-Alarm	Alarm																																																																								
b30	Lower limit alarm of L-N Voltage (3-N)	Non-Alarm	Alarm																																																																								
b31	Lower limit alarm of L-N Voltage (total)	Non-Alarm	Alarm																																																																								
	*2: As for the alarm judging items, refer to next page.																																																																										

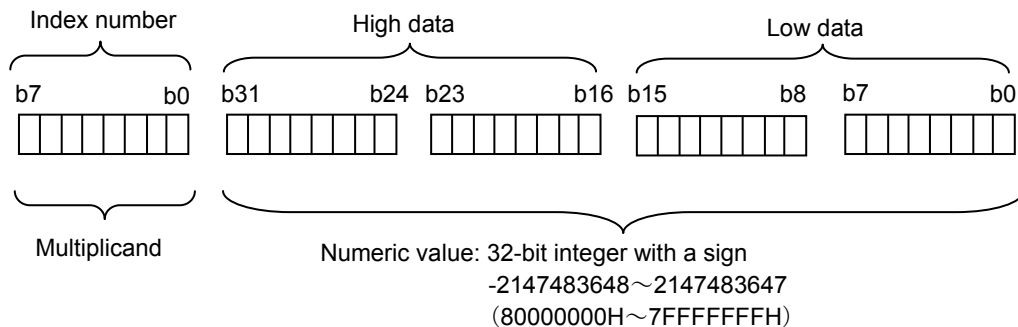
<Continuation>

Data	Data Format ③																																																							
Alarm state <div style="border: 1px solid black; padding: 5px; width: fit-content; margin: 10px 0;">Format③</div>	<p>■ Alarm judging items of each phase wiring is shown in the following.</p> <p>• Alarm judging items for 3P3W</p> <table border="1" data-bbox="416 333 1460 636"> <thead> <tr> <th></th> <th>Upper limit</th> <th>Lower limit</th> </tr> </thead> <tbody> <tr> <td>Demand current</td> <td>Phase 1, 2, 3</td> <td>Phase 1, 2, 3</td> </tr> <tr> <td>Voltage</td> <td>Phase 1-2, 2-3, 3-1</td> <td>Phase 1-2, 2-3, 3-1</td> </tr> <tr> <td>Current</td> <td>Phase 1, 2, 3</td> <td>Phase 1, 2, 3</td> </tr> <tr> <td>Active power</td> <td>ΣW</td> <td>ΣW</td> </tr> <tr> <td>Reactive power</td> <td>Σvar</td> <td>Σvar</td> </tr> <tr> <td>Power factor</td> <td>ΣPF</td> <td>ΣPF</td> </tr> <tr> <td>Harmonics voltage</td> <td>Phase 1-2, 2-3</td> <td>-</td> </tr> <tr> <td>Harmonics current</td> <td>Phase 1, 2, 3</td> <td>-</td> </tr> </tbody> </table> <p>• Alarm judging items for 3P4W</p> <table border="1" data-bbox="416 714 1460 1048"> <thead> <tr> <th></th> <th>Upper limit</th> <th>Lower limit</th> </tr> </thead> <tbody> <tr> <td>Demand current</td> <td>Phase 1, 2, 3, N</td> <td>Phase 1, 2, 3</td> </tr> <tr> <td>Voltage</td> <td>Phase 1-2, 2-3, 3-1, Phase 1-N, 2-N, 3-N</td> <td>Phase 1-2, 2-3, 3-1, Phase 1-N, 2-N, 3-N</td> </tr> <tr> <td>Current</td> <td>Phase 1, 2, 3, N</td> <td>Phase 1, 2, 3</td> </tr> <tr> <td>Active power</td> <td>ΣW</td> <td>ΣW</td> </tr> <tr> <td>Reactive power</td> <td>Σvar</td> <td>Σvar</td> </tr> <tr> <td>Power factor</td> <td>ΣPF</td> <td>ΣPF</td> </tr> <tr> <td>Harmonics voltage</td> <td>Phase 1-N, 2-N, 3-N</td> <td>-</td> </tr> <tr> <td>Harmonics current</td> <td>Phase 1, 2, 3, N</td> <td>-</td> </tr> </tbody> </table>			Upper limit	Lower limit	Demand current	Phase 1, 2, 3	Phase 1, 2, 3	Voltage	Phase 1-2, 2-3, 3-1	Phase 1-2, 2-3, 3-1	Current	Phase 1, 2, 3	Phase 1, 2, 3	Active power	ΣW	ΣW	Reactive power	Σvar	Σvar	Power factor	ΣPF	ΣPF	Harmonics voltage	Phase 1-2, 2-3	-	Harmonics current	Phase 1, 2, 3	-		Upper limit	Lower limit	Demand current	Phase 1, 2, 3, N	Phase 1, 2, 3	Voltage	Phase 1-2, 2-3, 3-1, Phase 1-N, 2-N, 3-N	Phase 1-2, 2-3, 3-1, Phase 1-N, 2-N, 3-N	Current	Phase 1, 2, 3, N	Phase 1, 2, 3	Active power	ΣW	ΣW	Reactive power	Σvar	Σvar	Power factor	ΣPF	ΣPF	Harmonics voltage	Phase 1-N, 2-N, 3-N	-	Harmonics current	Phase 1, 2, 3, N	-
	Upper limit	Lower limit																																																						
Demand current	Phase 1, 2, 3	Phase 1, 2, 3																																																						
Voltage	Phase 1-2, 2-3, 3-1	Phase 1-2, 2-3, 3-1																																																						
Current	Phase 1, 2, 3	Phase 1, 2, 3																																																						
Active power	ΣW	ΣW																																																						
Reactive power	Σvar	Σvar																																																						
Power factor	ΣPF	ΣPF																																																						
Harmonics voltage	Phase 1-2, 2-3	-																																																						
Harmonics current	Phase 1, 2, 3	-																																																						
	Upper limit	Lower limit																																																						
Demand current	Phase 1, 2, 3, N	Phase 1, 2, 3																																																						
Voltage	Phase 1-2, 2-3, 3-1, Phase 1-N, 2-N, 3-N	Phase 1-2, 2-3, 3-1, Phase 1-N, 2-N, 3-N																																																						
Current	Phase 1, 2, 3, N	Phase 1, 2, 3																																																						
Active power	ΣW	ΣW																																																						
Reactive power	Σvar	Σvar																																																						
Power factor	ΣPF	ΣPF																																																						
Harmonics voltage	Phase 1-N, 2-N, 3-N	-																																																						
Harmonics current	Phase 1, 2, 3, N	-																																																						

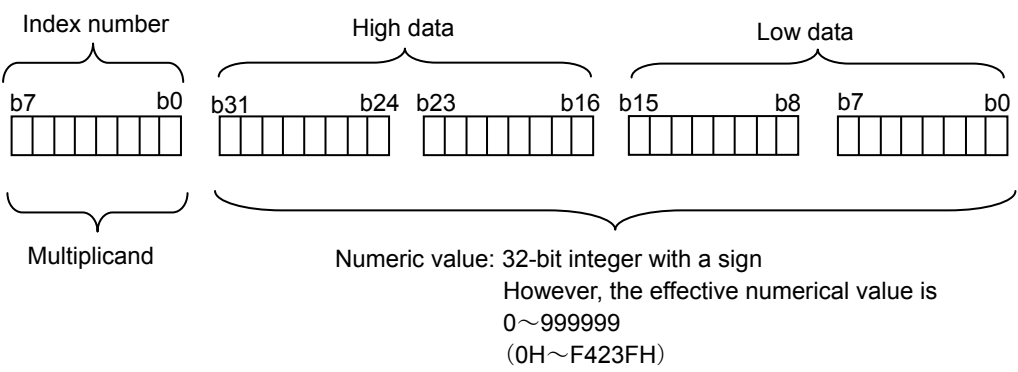
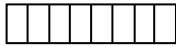
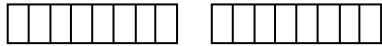
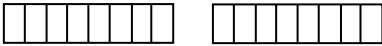
Table 6.8 Data Format (4/6)

Data Set-up	Data Format ④				
<div style="border: 1px solid black; border-radius: 15px; padding: 5px; width: fit-content;"> Primary current Primari voltage (L-L) Primary voltage (L-N) Secondary volatage (L-N) </div>	Index number	High data			Low data
	b7 b0 	b31 b24 b23 b16 	b15 b8 b7 b0 		
	Multiplicand	Numeric value: 32-bit integer with a sign -2147483648~2147483647 (80000000H~7FFFFFFFH)			
Format④	< Multiplicand > Multiplicand is fixed for every item according to primary current, primary voltage, and phase wiring. (Refer to p. 30.)				
Index number = 00H: The actual value is the numeric value. Index number = FFH: The actual value is 1/10 times the numeric value.					
< Example: Primary current, Primary voltage >					
		Set-up value	Multiplicand	Numeric value	Data
		Set-up value = 100.0A (Effective range = one place of decimals)	1/10times⇒FFH	1000⇒03E8H	FF000003E8H
		Set-up value = 400A (Effective range = Integer)	1 times⇒00H	400⇒0190H	0000000190H
		Set-up value = 110.0V (Effective range = one place of decimals)	1/10times⇒FFH	1100⇒044CH	FF00000FFCH
		Set-up value = 3300V (Effective range = Integer)	1 times⇒00H	3300⇒0CE4H	0000000CE4H

Table 6.9 Data Format (5/6)

Data Set-up	Data Format ⑤																																																																					
<div style="border: 1px solid black; border-radius: 10px; padding: 5px; width: fit-content;"> Phase wiring Time constant for DA Model code 16bit set register </div> <div style="border: 1px solid black; border-radius: 10px; padding: 5px; width: fit-content; margin-top: 20px;"> Format⑤ </div>	<div style="text-align: center;"> </div> <p style="text-align: center;">Multiplicand (=00H(fixed))</p> <p style="text-align: center;">Numeric value: 32-bit integer with a sign -2147483648~2147483647 (80000000H~7FFFFFFFH)</p> <p><Data(Numeric value)></p> <ul style="list-style-type: none"> ■ Phase wiring : 3P3W_2CT = 03H : 3P4W = 04H : 3P3W_3CT = 06H ※b31~b8: 0 fixed ■ Time constant for demand : The range of 0(= 0H) to 1800 seconds(= 708H) can be set up per second ■ Model code : 10H ← Model code of ME96NSR.(Fixed data) ※b31~b8: 0 fixed ■ 16bit set register <table border="1" style="width: 100%; border-collapse: collapse;"> <thead> <tr> <th rowspan="2">Bit</th> <th>Data</th> <th rowspan="2">OFF(0)</th> <th rowspan="2">ON(1)</th> </tr> <tr> <th>Content</th> </tr> </thead> <tbody> <tr> <td>b16</td> <td>Reset of all alarm</td> <td style="text-align: center;">—</td> <td style="text-align: center;">executed</td> </tr> <tr> <td>b17</td> <td>Reset of all max/min value and counting of energy</td> <td style="text-align: center;">—</td> <td style="text-align: center;">executed</td> </tr> <tr> <td>b18</td> <td>Reset of all max/min value</td> <td style="text-align: center;">—</td> <td style="text-align: center;">executed</td> </tr> <tr> <td>b19</td> <td>Unusable</td> <td style="text-align: center;">—</td> <td style="text-align: center;">—</td> </tr> <tr> <td>b20</td> <td>Unusable</td> <td style="text-align: center;">—</td> <td style="text-align: center;">—</td> </tr> <tr> <td>b21</td> <td>Unusable</td> <td style="text-align: center;">—</td> <td style="text-align: center;">—</td> </tr> <tr> <td>b22</td> <td>Unusable</td> <td style="text-align: center;">—</td> <td style="text-align: center;">—</td> </tr> <tr> <td>b23</td> <td>Unusable</td> <td style="text-align: center;">—</td> <td style="text-align: center;">—</td> </tr> <tr> <td>b24</td> <td>Reset of all digital input latch</td> <td style="text-align: center;">—</td> <td style="text-align: center;">executed</td> </tr> <tr> <td>b25</td> <td>Unusable</td> <td style="text-align: center;">—</td> <td style="text-align: center;">—</td> </tr> <tr> <td>b26</td> <td>Unusable</td> <td style="text-align: center;">—</td> <td style="text-align: center;">—</td> </tr> <tr> <td>b27</td> <td>Unusable</td> <td style="text-align: center;">—</td> <td style="text-align: center;">—</td> </tr> <tr> <td>b28</td> <td>Unusable</td> <td style="text-align: center;">—</td> <td style="text-align: center;">—</td> </tr> <tr> <td>b29</td> <td>Unusable</td> <td style="text-align: center;">—</td> <td style="text-align: center;">—</td> </tr> <tr> <td>b30</td> <td>Reset of counting of all energy</td> <td style="text-align: center;">—</td> <td style="text-align: center;">executed</td> </tr> <tr> <td>b31</td> <td>Unusable</td> <td style="text-align: center;">—</td> <td style="text-align: center;">—</td> </tr> </tbody> </table>	Bit	Data	OFF(0)	ON(1)	Content	b16	Reset of all alarm	—	executed	b17	Reset of all max/min value and counting of energy	—	executed	b18	Reset of all max/min value	—	executed	b19	Unusable	—	—	b20	Unusable	—	—	b21	Unusable	—	—	b22	Unusable	—	—	b23	Unusable	—	—	b24	Reset of all digital input latch	—	executed	b25	Unusable	—	—	b26	Unusable	—	—	b27	Unusable	—	—	b28	Unusable	—	—	b29	Unusable	—	—	b30	Reset of counting of all energy	—	executed	b31	Unusable	—	—
Bit	Data		OFF(0)			ON(1)																																																																
	Content																																																																					
b16	Reset of all alarm	—	executed																																																																			
b17	Reset of all max/min value and counting of energy	—	executed																																																																			
b18	Reset of all max/min value	—	executed																																																																			
b19	Unusable	—	—																																																																			
b20	Unusable	—	—																																																																			
b21	Unusable	—	—																																																																			
b22	Unusable	—	—																																																																			
b23	Unusable	—	—																																																																			
b24	Reset of all digital input latch	—	executed																																																																			
b25	Unusable	—	—																																																																			
b26	Unusable	—	—																																																																			
b27	Unusable	—	—																																																																			
b28	Unusable	—	—																																																																			
b29	Unusable	—	—																																																																			
b30	Reset of counting of all energy	—	executed																																																																			
b31	Unusable	—	—																																																																			

Table 6.10 Data Format (6/6)

Data Set-up	Data Format ⑥																																																		
Alarm item	Index number	High data			Low data																																														
Format⑥	b7 b0	b31 b24	b23 b16	b15 b8	b7 b0																																														
	[8-bit box]	[8-bit box]	[8-bit box]	[8-bit box]	[8-bit box]																																														
	00H(fixed)	Alarm item 1	Alarm item 2	Alarm item 3	Alarm item 4																																														
	<p>Note: The numbers of alarms which can set are 4 items.</p> <p>< Content of alarm items ></p> <table border="1" style="width: 100%; border-collapse: collapse;"> <thead> <tr> <th style="width: 15%;">Data</th> <th>Explanation</th> </tr> </thead> <tbody> <tr><td>00H</td><td>No alarm</td></tr> <tr><td>01H</td><td>The upper limit alarm of current</td></tr> <tr><td>02H</td><td>The lower limit alarm of current</td></tr> <tr><td>03H</td><td>The upper limit alarm of phase N current</td></tr> <tr><td>09H</td><td>The upper limit alarm of current demand</td></tr> <tr><td>0AH</td><td>The lower limit alarm of current demand</td></tr> <tr><td>0BH</td><td>The upper limit alarm of phase N current demand</td></tr> <tr><td>11H</td><td>The upper limit alarm of L-L voltage</td></tr> <tr><td>12H</td><td>The lower limit alarm of L-L voltage</td></tr> <tr><td>13H</td><td>The upper limit alarm of L-N voltage</td></tr> <tr><td>14H</td><td>The lower limit alarm of L-N voltage</td></tr> <tr><td>15H</td><td>The upper limit alarm of active power</td></tr> <tr><td>16H</td><td>The lower limit alarm of active power</td></tr> <tr><td>19H</td><td>The upper limit alarm of reactive power</td></tr> <tr><td>1AH</td><td>The lower limit alarm of reactive power</td></tr> <tr><td>1BH</td><td>The upper limit alarm of power factor</td></tr> <tr><td>1CH</td><td>The lower limit alarm of power factor</td></tr> <tr><td>1DH</td><td>The upper limit alarm of frequency</td></tr> <tr><td>1EH</td><td>The lower limit alarm of frequency</td></tr> <tr><td>1FH</td><td>The upper limit alarm of current harmonics</td></tr> <tr><td>20H</td><td>The upper limit alarm of voltage harmonics</td></tr> <tr><td>21H</td><td>The upper limit alarm of phase N current harmonics</td></tr> </tbody> </table>					Data	Explanation	00H	No alarm	01H	The upper limit alarm of current	02H	The lower limit alarm of current	03H	The upper limit alarm of phase N current	09H	The upper limit alarm of current demand	0AH	The lower limit alarm of current demand	0BH	The upper limit alarm of phase N current demand	11H	The upper limit alarm of L-L voltage	12H	The lower limit alarm of L-L voltage	13H	The upper limit alarm of L-N voltage	14H	The lower limit alarm of L-N voltage	15H	The upper limit alarm of active power	16H	The lower limit alarm of active power	19H	The upper limit alarm of reactive power	1AH	The lower limit alarm of reactive power	1BH	The upper limit alarm of power factor	1CH	The lower limit alarm of power factor	1DH	The upper limit alarm of frequency	1EH	The lower limit alarm of frequency	1FH	The upper limit alarm of current harmonics	20H	The upper limit alarm of voltage harmonics	21H	The upper limit alarm of phase N current harmonics
Data	Explanation																																																		
00H	No alarm																																																		
01H	The upper limit alarm of current																																																		
02H	The lower limit alarm of current																																																		
03H	The upper limit alarm of phase N current																																																		
09H	The upper limit alarm of current demand																																																		
0AH	The lower limit alarm of current demand																																																		
0BH	The upper limit alarm of phase N current demand																																																		
11H	The upper limit alarm of L-L voltage																																																		
12H	The lower limit alarm of L-L voltage																																																		
13H	The upper limit alarm of L-N voltage																																																		
14H	The lower limit alarm of L-N voltage																																																		
15H	The upper limit alarm of active power																																																		
16H	The lower limit alarm of active power																																																		
19H	The upper limit alarm of reactive power																																																		
1AH	The lower limit alarm of reactive power																																																		
1BH	The upper limit alarm of power factor																																																		
1CH	The lower limit alarm of power factor																																																		
1DH	The upper limit alarm of frequency																																																		
1EH	The lower limit alarm of frequency																																																		
1FH	The upper limit alarm of current harmonics																																																		
20H	The upper limit alarm of voltage harmonics																																																		
21H	The upper limit alarm of phase N current harmonics																																																		

■ Effective Range and Multiplicand

The conditions of multiplying factor by setup of each element are shown below.

Element	Condition		Multiplying factor
Voltage Harmonics voltage	Primary voltage	0V~440V less than	×0.1
		440V or more	×1
Current Current demand Harmonics current	Primary current	0A~4A less than	×0.001
		4A~40A less than	×0.01
		40A~400A less than	×0.1
		400A or more	×1
Active power Reactive power Apparent power	Primary rated power	0kW~1.2kW less than	×0.0001
		1.2kW~12kW less than	×0.001
		12kW~120kW less than	×0.01
		120kW~1200kW less than	×0.1
		1200kW~12000kW less than	×1
		12000kW~120000kW less than	×10
Active energy Reactive energy	Primary rated power	0kW~10kW less than	×0.01
		10kW~100kW less than	×0.1
		100kW~1000kW less than	×1
		1000kW~10000kW less than	×10
		10000kW~100000kW less than	×100
		100000kW or more	×1000
Active energy (extended) Reactive energy (extended)	Primary rated power	0kW~10kW less than	×0.00001
		10kW~100kW less than	×0.0001
		100kW~1000kW less than	×0.001
		1000kW~10000kW less than	×0.01
		10000kW~100000kW less than	×0.1
		100000kW or more	×1
Frequency	—	—	×0.1
Power factor	—	—	×0.1
Harmonics distortion	—	—	×0.1

※How to calculate primary rated power.

$$\text{Primary rated power[kW]} = \frac{\alpha \times (\text{Primary voltage}) \times (\text{Primary current})}{1000}$$

$$\alpha : 3 \quad 3P3W_2CT, 3P3W_3CT$$

$$\sqrt{3} \quad 3P4W$$

(2) Data Set Command (2H)

2H	Data Set																																																																
<ul style="list-style-type: none"> After writing the command as shown below into the remote register RWwm, set the command execution request flag to ON (1). When the command completion reply flag is turned on, the specified item is reset. The details of the data written into the remote register RWwm are shown in the Table 6.5 to Table 6.11. <p>※After writing the set-up value, about 0.5 seconds (max 2 seconds) is needed to restart the measurement based on new set-up value.</p> <p>※If you write the set-up value continuously, please give about 0.5 seconds (max 2 seconds) between the set-up value.</p>																																																																	
<table border="1" style="width: 100%;"> <tr> <td style="width: 50%; text-align: center;">Remote register RWwm (PLC→ME96NSR)</td> <td style="width: 50%; text-align: center;">Remote register RWrn (ME96NSR→PLC)</td> </tr> <tr> <td style="text-align: center;"> <table border="1" style="width: 100%;"> <tr> <td style="width: 15%;"></td> <td style="width: 15%; text-align: center;">b15</td> <td style="width: 15%; text-align: center;">b8</td> <td style="width: 15%; text-align: center;">b7</td> <td style="width: 15%; text-align: center;">b4</td> <td style="width: 15%; text-align: center;">b3</td> <td style="width: 15%; text-align: center;">b0</td> </tr> <tr> <td style="text-align: center;">m</td> <td style="text-align: center;">Group No.</td> <td style="text-align: center;">0H (Unit.No)</td> <td style="text-align: center;">2H</td> <td colspan="3"></td> </tr> <tr> <td style="text-align: center;">m+1</td> <td style="text-align: center;">Index number</td> <td colspan="5" style="text-align: center;">Channel No.</td> </tr> <tr> <td style="text-align: center;">m+2</td> <td colspan="6" style="text-align: center;">Low data</td> </tr> <tr> <td style="text-align: center;">m+3</td> <td colspan="6" style="text-align: center;">High data</td> </tr> </table> </td> <td style="text-align: center;"> <table border="1" style="width: 100%;"> <tr> <td style="width: 15%;"></td> <td style="width: 15%; text-align: center;">b15</td> <td style="width: 15%; text-align: center;">b8</td> <td style="width: 15%; text-align: center;">b7</td> <td style="width: 15%; text-align: center;">b0</td> </tr> <tr> <td style="text-align: center;">n</td> <td style="text-align: center;">Channel No.</td> <td colspan="3" style="text-align: center;">Group No.</td> </tr> <tr> <td style="text-align: center;">n+1</td> <td style="text-align: center;">00H</td> <td colspan="3" style="text-align: center;">00H</td> </tr> <tr> <td style="text-align: center;">n+2</td> <td style="text-align: center;">00H</td> <td colspan="3" style="text-align: center;">00H</td> </tr> <tr> <td style="text-align: center;">n+3</td> <td style="text-align: center;">00H</td> <td colspan="3" style="text-align: center;">00H</td> </tr> </table> </td> </tr> </table> <p>(※)At data set , Unit No. is fixed 0H in ME96NSR.</p>		Remote register RWwm (PLC→ME96NSR)	Remote register RWrn (ME96NSR→PLC)	<table border="1" style="width: 100%;"> <tr> <td style="width: 15%;"></td> <td style="width: 15%; text-align: center;">b15</td> <td style="width: 15%; text-align: center;">b8</td> <td style="width: 15%; text-align: center;">b7</td> <td style="width: 15%; text-align: center;">b4</td> <td style="width: 15%; text-align: center;">b3</td> <td style="width: 15%; text-align: center;">b0</td> </tr> <tr> <td style="text-align: center;">m</td> <td style="text-align: center;">Group No.</td> <td style="text-align: center;">0H (Unit.No)</td> <td style="text-align: center;">2H</td> <td colspan="3"></td> </tr> <tr> <td style="text-align: center;">m+1</td> <td style="text-align: center;">Index number</td> <td colspan="5" style="text-align: center;">Channel No.</td> </tr> <tr> <td style="text-align: center;">m+2</td> <td colspan="6" style="text-align: center;">Low data</td> </tr> <tr> <td style="text-align: center;">m+3</td> <td colspan="6" style="text-align: center;">High data</td> </tr> </table>		b15	b8	b7	b4	b3	b0	m	Group No.	0H (Unit.No)	2H				m+1	Index number	Channel No.					m+2	Low data						m+3	High data						<table border="1" style="width: 100%;"> <tr> <td style="width: 15%;"></td> <td style="width: 15%; text-align: center;">b15</td> <td style="width: 15%; text-align: center;">b8</td> <td style="width: 15%; text-align: center;">b7</td> <td style="width: 15%; text-align: center;">b0</td> </tr> <tr> <td style="text-align: center;">n</td> <td style="text-align: center;">Channel No.</td> <td colspan="3" style="text-align: center;">Group No.</td> </tr> <tr> <td style="text-align: center;">n+1</td> <td style="text-align: center;">00H</td> <td colspan="3" style="text-align: center;">00H</td> </tr> <tr> <td style="text-align: center;">n+2</td> <td style="text-align: center;">00H</td> <td colspan="3" style="text-align: center;">00H</td> </tr> <tr> <td style="text-align: center;">n+3</td> <td style="text-align: center;">00H</td> <td colspan="3" style="text-align: center;">00H</td> </tr> </table>		b15	b8	b7	b0	n	Channel No.	Group No.			n+1	00H	00H			n+2	00H	00H			n+3	00H	00H		
Remote register RWwm (PLC→ME96NSR)	Remote register RWrn (ME96NSR→PLC)																																																																
<table border="1" style="width: 100%;"> <tr> <td style="width: 15%;"></td> <td style="width: 15%; text-align: center;">b15</td> <td style="width: 15%; text-align: center;">b8</td> <td style="width: 15%; text-align: center;">b7</td> <td style="width: 15%; text-align: center;">b4</td> <td style="width: 15%; text-align: center;">b3</td> <td style="width: 15%; text-align: center;">b0</td> </tr> <tr> <td style="text-align: center;">m</td> <td style="text-align: center;">Group No.</td> <td style="text-align: center;">0H (Unit.No)</td> <td style="text-align: center;">2H</td> <td colspan="3"></td> </tr> <tr> <td style="text-align: center;">m+1</td> <td style="text-align: center;">Index number</td> <td colspan="5" style="text-align: center;">Channel No.</td> </tr> <tr> <td style="text-align: center;">m+2</td> <td colspan="6" style="text-align: center;">Low data</td> </tr> <tr> <td style="text-align: center;">m+3</td> <td colspan="6" style="text-align: center;">High data</td> </tr> </table>		b15	b8	b7	b4	b3	b0	m	Group No.	0H (Unit.No)	2H				m+1	Index number	Channel No.					m+2	Low data						m+3	High data						<table border="1" style="width: 100%;"> <tr> <td style="width: 15%;"></td> <td style="width: 15%; text-align: center;">b15</td> <td style="width: 15%; text-align: center;">b8</td> <td style="width: 15%; text-align: center;">b7</td> <td style="width: 15%; text-align: center;">b0</td> </tr> <tr> <td style="text-align: center;">n</td> <td style="text-align: center;">Channel No.</td> <td colspan="3" style="text-align: center;">Group No.</td> </tr> <tr> <td style="text-align: center;">n+1</td> <td style="text-align: center;">00H</td> <td colspan="3" style="text-align: center;">00H</td> </tr> <tr> <td style="text-align: center;">n+2</td> <td style="text-align: center;">00H</td> <td colspan="3" style="text-align: center;">00H</td> </tr> <tr> <td style="text-align: center;">n+3</td> <td style="text-align: center;">00H</td> <td colspan="3" style="text-align: center;">00H</td> </tr> </table>		b15	b8	b7	b0	n	Channel No.	Group No.			n+1	00H	00H			n+2	00H	00H			n+3	00H	00H						
	b15	b8	b7	b4	b3	b0																																																											
m	Group No.	0H (Unit.No)	2H																																																														
m+1	Index number	Channel No.																																																															
m+2	Low data																																																																
m+3	High data																																																																
	b15	b8	b7	b0																																																													
n	Channel No.	Group No.																																																															
n+1	00H	00H																																																															
n+2	00H	00H																																																															
n+3	00H	00H																																																															

m, n : Address is allocated to the master module by the station number setting.

Table 6.11 List of Group and Channel for Set-up

Hex.		Content name	Range	Setting unit	Data Type
Group	Channel				
E0	11	Primary current	(Note1)	—	④
E0	12	Primary voltage(L-L)	(Note2)	—	④
E0	1B	Primary voltage(L-N)	(Note3)	—	④
E0	1C	Secondary voltage	63.5V,100V,110V,115V,120V,220V	3P3W: 100V, 110V, 220V 3P4W: Except for 220V	④
E0	13	Phase & Wiring	3P3W_2CT,3P3W_3CT,3P4W	—	⑤
E0	18	Alarm Items	Refer to Table 6.10	—	⑥
02	E0	Time constant for DA	0~1800s	(Note4)	⑤
80	01	active energy import	0~999999×Multiplicand(Note5)	1×Multiplicand	②
80	63	active energy expoer	0~999999×Multiplicand(Note5)	1×Multiplicand	②
81	01	reactive energy import LAG	0~999999×Multiplicand(Note5)	1×Multiplicand	②
81	63	reactive energy export LAG	0~999999×Multiplicand(Note5)	1×Multiplicand	②
81	64	reactive energy import LEAD	0~999999×Multiplicand(Note5)	1×Multiplicand	②
81	65	reactive energy export LEAD	0~999999×Multiplicand(Note5)	1×Multiplicand	②
01	14	current upper limit	5% to 120% of primary current	1%step Initial value: 100%	①
01	15	current lower limit	3% to 95% of primary current	1%step Initial value: 10%	①
01	94	current upper limit(Phase N)	5% to 120% of primary current	1%step Initial value: 100%	①
02	14	current demand upper limit	5% to 120% of primary current	1%step Initial value: 100%	①
02	15	current demand lower limit	3% to 95% of primary current	1%step Initial value: 10%	①
02	94	current demand upper limit (Phase N)	5% to 120% of primary current	1%step Initial value: 100%	①
05	14	voltage upper limit (L-L)	25% to 135% of primary voltage	1%step Initial value: 110%	①
05	15	voltage lower limit (L-L)	20% to 95% of primary voltage	1%step Initial value: 70%	①
03	14	voltage upper limit (L-N)	25% to 135% of primary voltage	1%step Initial value: 110%	①
03	15	voltage lower limit (L-N)	20% to 95% of primary voltage	1%step Initial value: 70%	①
07	14	active power upper limit	-95% to 120% of rated active power	1%step Initial value: 100%	①
07	15	active power lower limit	-120% to 95% of rated active power	1%step Initial value: 3%	①
09	14	reactive power upper limit	-95% to 120% of rated reactive power	1%step Initial value: 100%	①
09	15	reactive power lower limit	-120% to 95% of rated reactive power	1%step Initial value: 3%	①
0D	14	power factor upper limit	-0.05 to 1.000 to 0.05	0.05 step Initial value: 1.000	①
0D	15	power factor lower limit	-0.05 to 1.000 to 0.05	0.05 step Initial value: -0.50	①
0F	14	Frequency upper limit	45.0 to 65.0Hz	1Hz step Initial value: 65Hz	①
0F	15	Frequency lower limit	45.0 to 65.0Hz	1Hz step Initial value: 45Hz	①
77	E1	H.V(L-N) upper limit	0.5% to 20.0%	0.5%step Initial value: 3.5%	①
76	E1	H.V(L-L) upper limit	0.5% to 20.0%	0.5%step Initial value: 3.5%	①
75	E1	H.A upper limit	5% to 120%	1%step Initial value:35%	①
75	F1	H.A upper limit (Phase N)	5% to 120%	1%step Initial value:35%	①
A1	3A	16bit set register	Refer to Table 6.9	—	⑤

When the group No. or channel No. of the above is not specified, the error code of invalid number is replied.

When out of the range is set, the error code of invalid data is replied, and set-up value is not changed.

Note1: From the most significant digit to 2 figures can be freely set up in the range of 5A to 30000A.

Note2: The set-up range is different by setting of phase wiring.

- At 3P4W

Corresponds to only 190V, 415V, 440V, setting vaule is changed as follows.

Setting value	Using VT/ Direct input	Direct Voltage	VT secondary Voltage	VT primary Voltage
190V	Direct input	110V/190V	—	—
415V	Using VT	—	63.5V/110V	240V/415V
440V	Using VT	—	63.5V/110V	254V/440V

- At 3P3W_2CT, 3P3W_3CT

- ◆ When set in the range from 221V to 750000V

It is set "Using VT", and sets the primary voltage which is transmitted.

From the most significant digit to 3 figures can be freely set up in the range of 221V to 750000V.

- ◆ At 110V or 220V

It is set "Direct input", and sets the primary voltage which is transmitted as the direct input voltage.

Note3: The set-up range is different by setting of phase wiring.

- At 3P4W

- ◆ When set in the range from 278V to 750000V

It is set "Using VT", and sets the primary voltage which is transmitted.

From the most significant digit to 3 figures can be freely set up in the range of 278V to 750000V.

- ◆ At the 63.5V, 100V, 110V, 220V, 240V, 254V or 277V

It is set "Direct input", and sets the primary voltage which is transmitted as the direct input voltage.

- At 3P3W_2CT, 3P3W_3CT

The error code of invalid channel number is replied.

Note4: The range of time constant is as follows. It is set by seconds.

0s, 10s, 20s, 30s, 40s, 50s, 1min, 2min, 3min, 4min, 5min, 6min, 7min, 8min, 9min, 10min, 15min, 20min, 25min, 30min.

Note5: The multiplicand value is changed by the set-up value of phase wiring, primary voltage, and primary current.
(Refer to P. 30)

6.2.3 About Error Occurrence

When the command and related data transmitted to ME96NSR is improper or ME96NSR is in H/W error, RX(n+1)A (Error status flag) becomes 1(ON), the error code shown in Table 6.12 is returned as reply data.

Table 6.12 Error Code

Error Description	Error Code (Hex.)
Illegal command or packet length	40h
Invalid group number	41h
Invalid channel number	42h
ME96NSR is in set-up mode or test mode	43h, 44h
Invalid data for set-up	51h
It is not set the item of alarm	55h

If an error occurs, the error code is written into the RW_{rn} as shown in the figure below, and RX(n+1)A (error status flag) is turned on (error occurrence) and RX(n+1)B (remote READY) is turned off (normal communication stop). For the error resetting method, refer to “5.4 Error Communication”.

- (1) At the command No. is in range

Remote register RW _{rn}				
	b15	b8	b7	b0
n	Channel No.		Group No.	
n+1	00H		00H	
n+2	00H		Error code	
n+3	00H		00H	

- (2) At the command No. is out of range

Remote register RW _{rn}				
	b15	b8	b7	b0
n	00H		Error code	
n+1	00H		00H	
n+2	00H		00H	
n+3	00H		00H	

7. Abbreviations and Special Terms

Abbreviations and special terms used in this manual are shown below:

Abbreviation and Special Terms	Description
Master station	Station which controls remote stations and local stations. One station is required for one system.
Local station	Station with the CPU which can communicate with master station and other local stations.
Remote I/O station	Remote station which deals with bit information only.
Remote device station	Remote station which deals with bit information and word information.
Remote station	General name for remote I/O station and remote device station. Controlled by a master station.
Intelligent device station	Station that can perform transient transmission.
RX	Remote input
RY	Remote output
RWw	Remote resister (write area)
RWr	Remote resister (read area)
Command	Identification code allocated to items to be monitored or set. ME96NSR uses a special-purpose command that is transmitted to monitor each measurement value or set each parameter.
Demand value	The demand value is an approximate average value during the demand time period. When it is set to 0, each demand present value becomes equivalent to the present value.

8. Program Example

8.1 Program Content

This program example is assumed the system configuration in below.

In the program, at first, the parameters of the linked number and station information are set, and the data link with the parameter of buffer memory starts up.

Next, the reading data shown in below is monitored continuously.

Also, this program is made by using "SW8D5C-GPPW GX Developer".

8.2 System Configuration

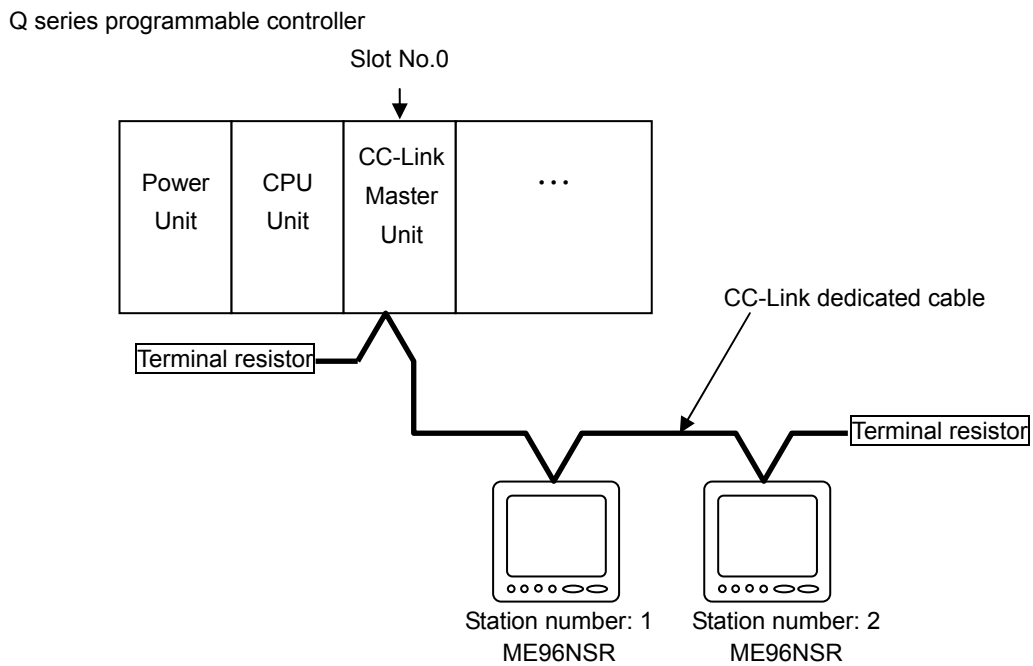

※Reading data

Station number 1: ME96NSR	Phase 1 current, Phase 2 current, Phase 3 current, 1-N voltage, 2-N voltage, 3-N voltage, Phase 1 active power, Phase 2 active power, Phase 3 active power
Station number 2: ME96NSR	Active energy (import), Average current, Average L-N voltage, Total active power, Total reactive power, Total power factor, Frequency

8.3 Device Allocation

Allocation of transmitted device

Items	Contents	Device No.	Note
Remote input(RX)	Station number 1:Remote input (RX00 to RX1F)	X100 to X11F	Set X100 to remote input(RX) refresh device.
	Station number 2:Remote input (RX20 to RX3F)	X120 to X13F	
Remote output(RY)	Station number 1:Remote output (RY00 to RY1F)	Y100 to Y11F	Set Y100 to remote output(RY) refresh device.
	Station number 2:Remote output (RY20 to RY3F)	Y120 to Y13F	
Remote register(RWr)	Station number 1:Remote register(RWr0 to RWr3)	W300 to W303	Set W300 to remote register(RWr) refresh device.
	Station number 2:Remote register (RWr4 to RWr7)	W304 to W307	
Remote register(RWw)	Station number 1:Remote register (RWw0 to RWw3)	W400 to W403	Set W400 to remote register(RWw) refresh device.
	Station number 2:Remote register (RWw4 to RWw7)	W404 to W407	
Link special relay(SB)	Link special relay of master station(SB0 to SB01FF)	SB0 to SB01FF	Set SB0 to link special relay(SB) refresh device.
Link special register(SW)	Link special register of master station (SW0 to SW01FF)	SW0 to SW01FF	Set SW0 to link special register(SW) refresh device.
Number of taking items	Station number 1: Number of monitoring items	D0	Number of items are mentioned in section 8.2.
	Station number 2: Number of monitoring items	D1	
Number of taken items	Station number 1: For calculation of number of taken items.	D10	
	Station number 2: For calculation of number of taken items.	D11	
Send data items	Station number 1: Send data for monitoring	D100 to D117	Content of items are mentioned in section 8.2.
	Station number 2: Send data for monitoring	D120 to D133	
Writing send data	Station number 1: Data for writing RWw	D400 to D403	
	Station number 2: Data for writing RWw	D404 to D407	
Reading recive data	Station number 1: Data for reading RWr	D300 to D303	
	Station number 2: Data for reading RWr	D304 to D307	
Error code	Station number 1: Error code	D500 to D503	
	Station number 2: Error code	D504 to D504	
Monitor data	Station number 1: Monitor data (only numeric value)	R0 to R17	
	Station number 2: Monitor data (only numeric value)	R40 to R33	
Data link status	Station number 1: Data link status	M0	
	Station number 2: Data link status	M1	
Command setting	Station number 1: Command setting completion flag	M100	
	Station number 2: Command setting completion flag	M110	
Transmitting completion	Station number 1: Transmitting completion flag	M101	
	Station number 2: Transmitting completion flag	M111	

8.4 Parameter Settings

Parameter settings are set as following with GX Developer.

8.4.1 Network Parameter Settings and Auto Refresh Parameter Settings

The following is shown CC-Link network parameter settings and auto refresh parameter settings.

ネットワークパラメータ設定画面のスクリーンショット。画面には、ネットワークパラメータ設定の表が表示されています。

項目	1	2	3	4
先頭I/ONo	0000			
動作設定	動作設定			
種別	マスタ局			
データリンク種別	マスタ局CPUマスタ自動起動			
モード設定	リモートVer.1モード			
総接続台数	2			
リモート入力(RX)リフレッシュデバイス	X100			
リモート出力(RY)リフレッシュデバイス	Y100			
リモートレジスタ(RWw)リフレッシュデバイス	W300			
リモートレジスタ(RWw)リフレッシュデバイス	W400			
Ver.2リモート入力(RX)リフレッシュデバイス				
Ver.2リモート出力(RY)リフレッシュデバイス				
Ver.2リモートレジスタ(RWw)リフレッシュデバイス				
Ver.2リモートレジスタ(RWw)リフレッシュデバイス				
特殊リレー(SB)リフレッシュデバイス	S80			
特殊レジスタ(SW)リフレッシュデバイス	SW0			
リトライ回数	1			
自動復列台数	1			
待機マスタ局番号				
CPUの指定	停止			
スキャンモード指定	非同期			
タイムアウト時間設定	0			
局情報設定	局情報			
リモートデバイス局インジカ設定	インジカ設定			
書き込み設定	書き込み設定			

設定項目の詳細: 必須設定 (未設定 / 設定済み) 必要に応じ設定 (未設定 / 設定済み)

ボタン: X/Y割付確認, クリア, チェック, 設定終了, キャンセル

8.4.2 Operational Settings

Operational settings are as follows.

8.4.3 Station Information Settings

Station information settings are as follows.

台数/局番	局種別	拡張サイクリック設定	占有局数	リモート局点数	予約/無効局指定	インテリジェント用バッファ指定(ワード)		
						送信	受信	自動
1/1	リモートデバイス局	1倍設定	1局占有	32点	設定なし			
2/2	リモートデバイス局	1倍設定	1局占有	32点	設定なし			

8.5 Program Example

* Data clear

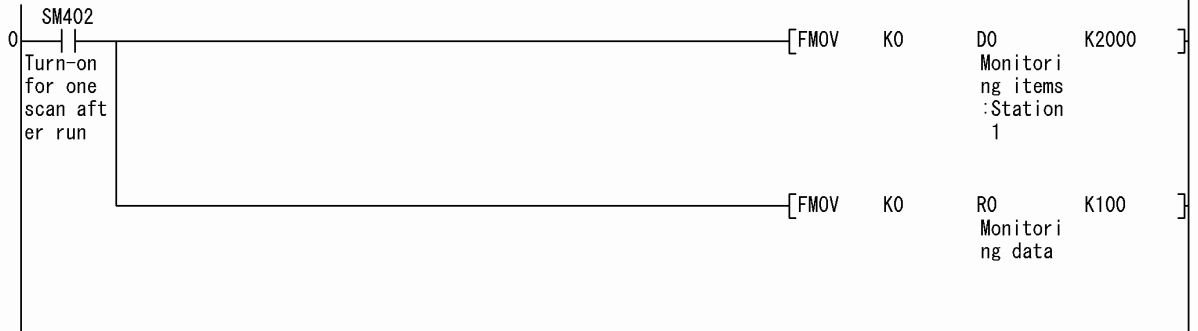

* Set the number of monitoring items

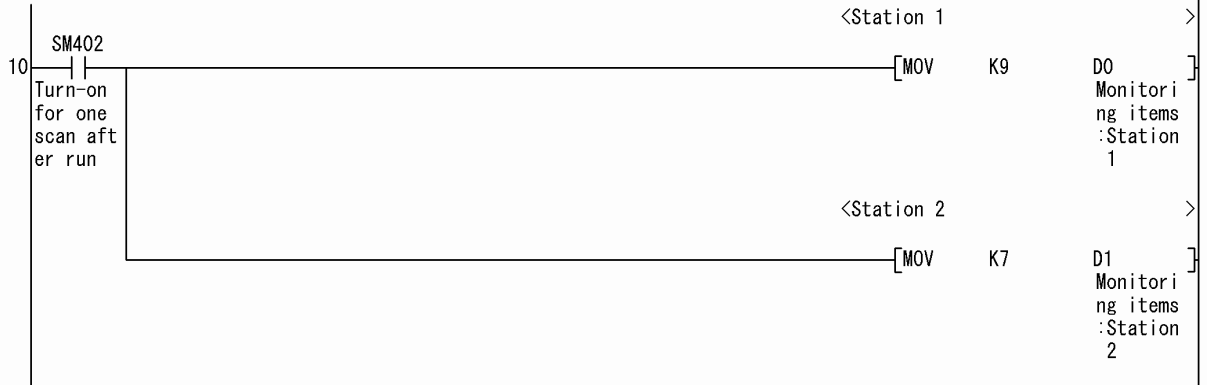

* Set the send data (station 1)

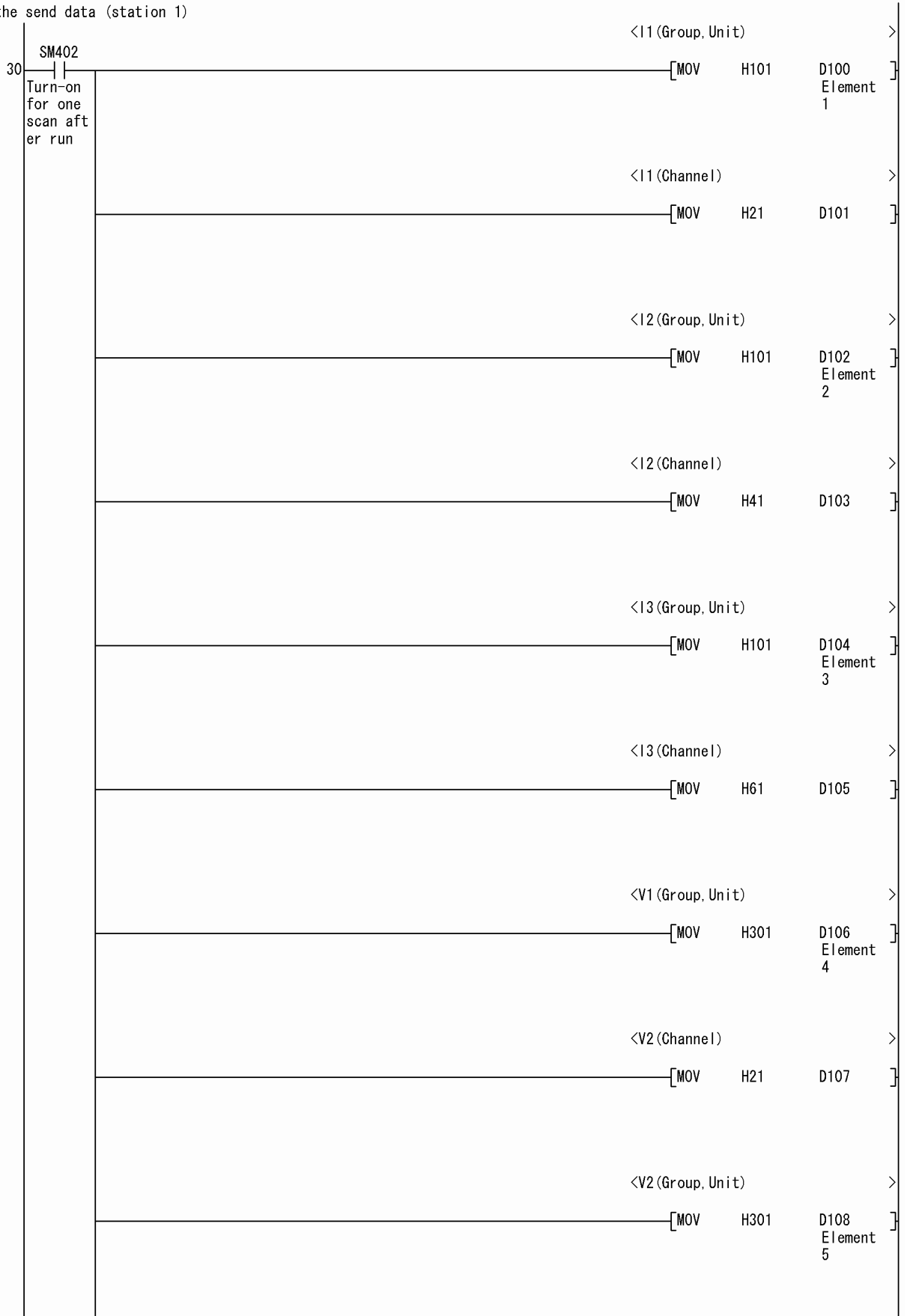

<V2 (Channel)	>
[MOV H41 D109]]
<V3 (Group, Unit)	>
[MOV H301 D110 Element 6]]
<V3 (Channel)	>
[MOV H61 D111]]
<W1 (Group, Unit)	>
[MOV H701 D112 Element 7]]
<W1 (Channel)	>
[MOV H21 D113]]
<W2 (Group, Unit)	>
[MOV H701 D114 Element 8]]
<W2 (Channel)	>
[MOV H41 D115]]
<W3 (Group, Unit)	>
[MOV H701 D116 Element 9]]
<W3 (Channel)	>
[MOV H61 D117]]

* Set the send data (station 2)



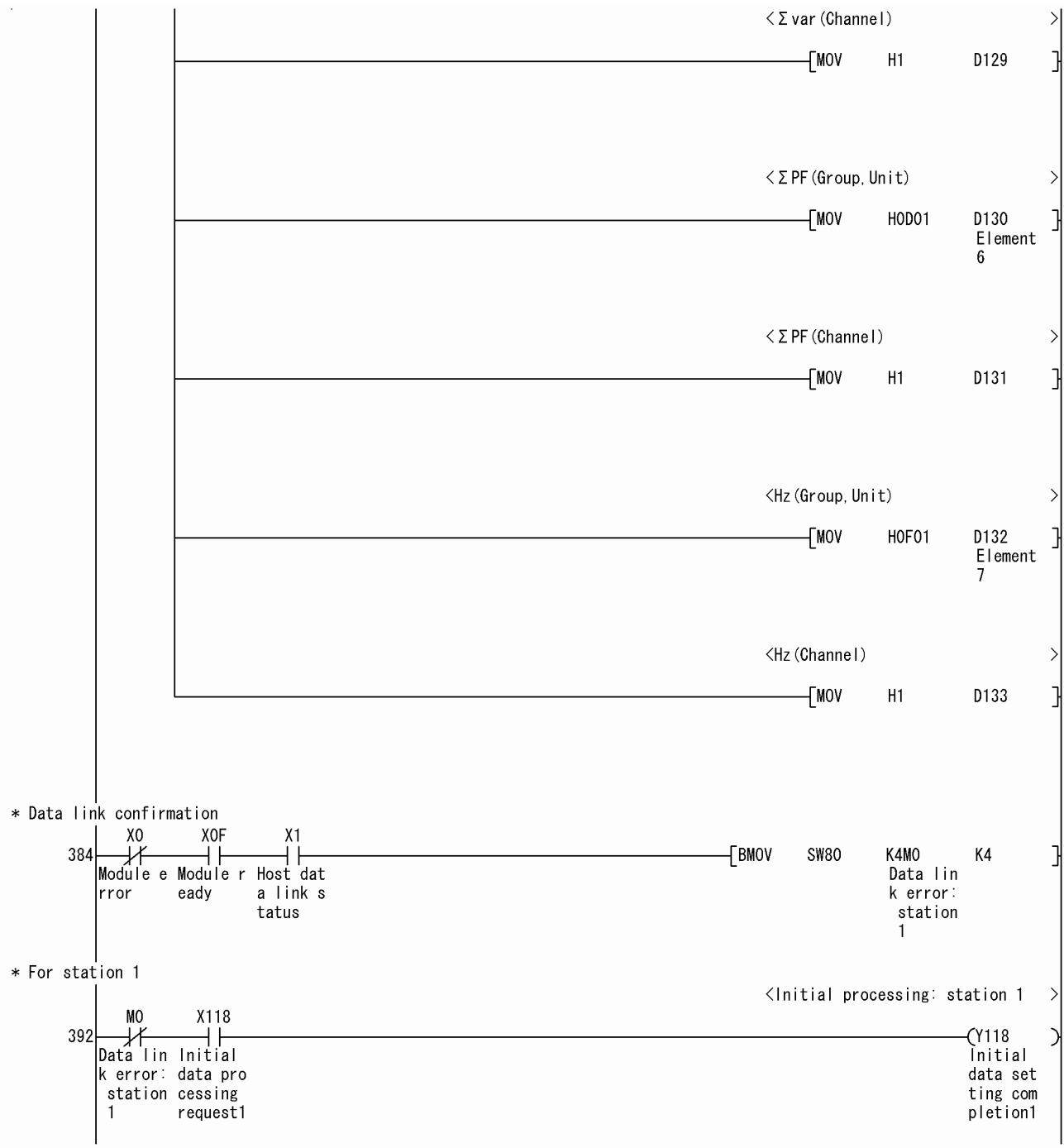

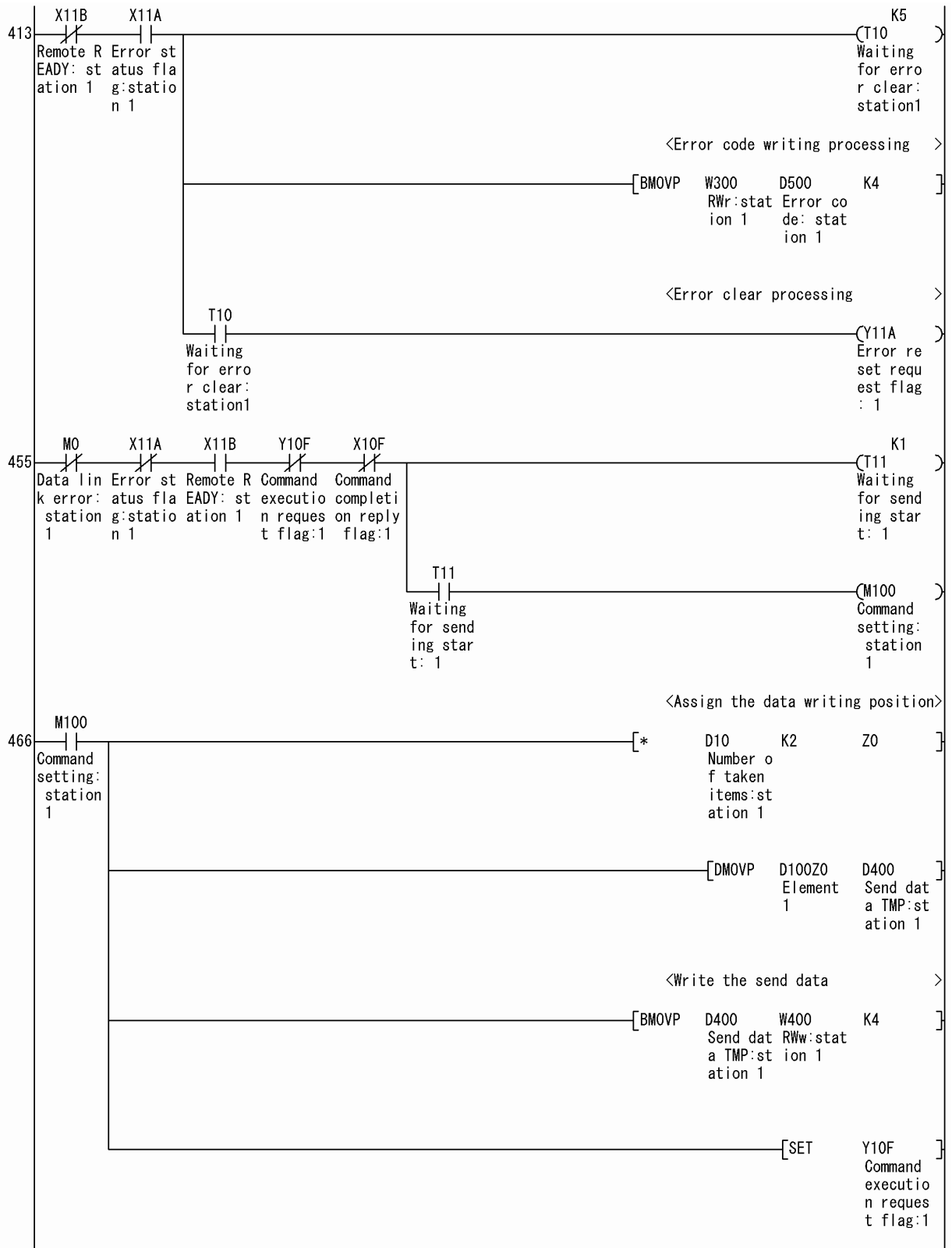

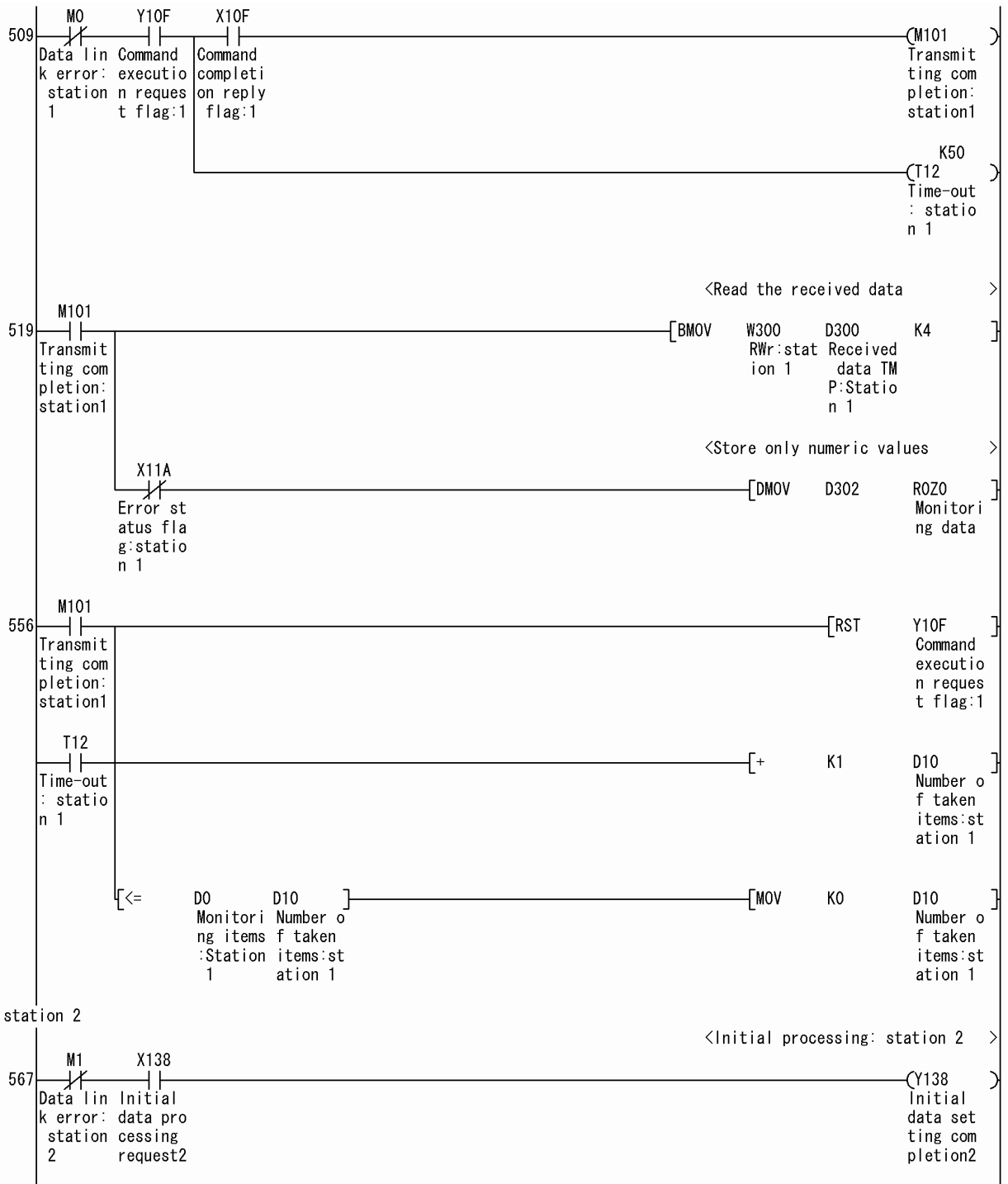

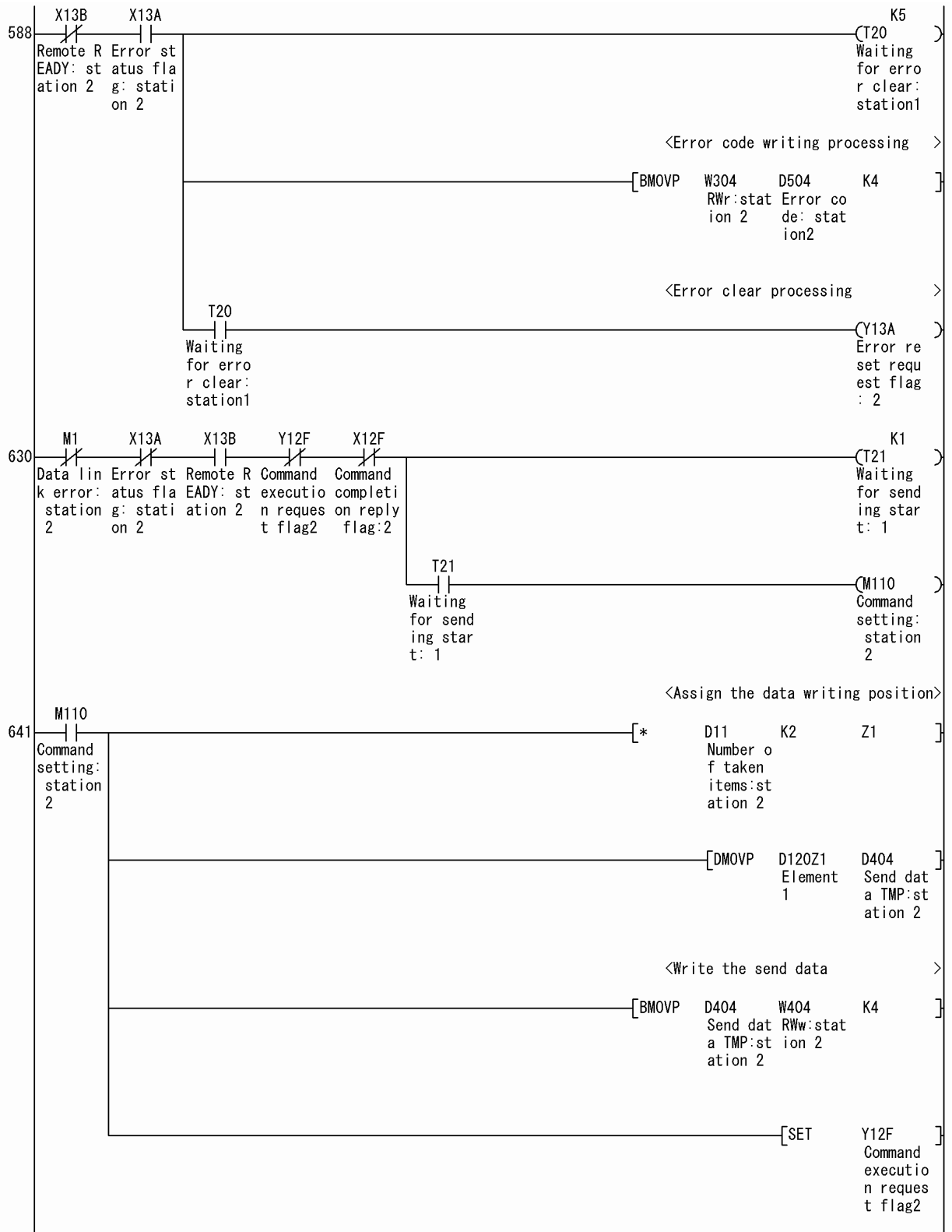

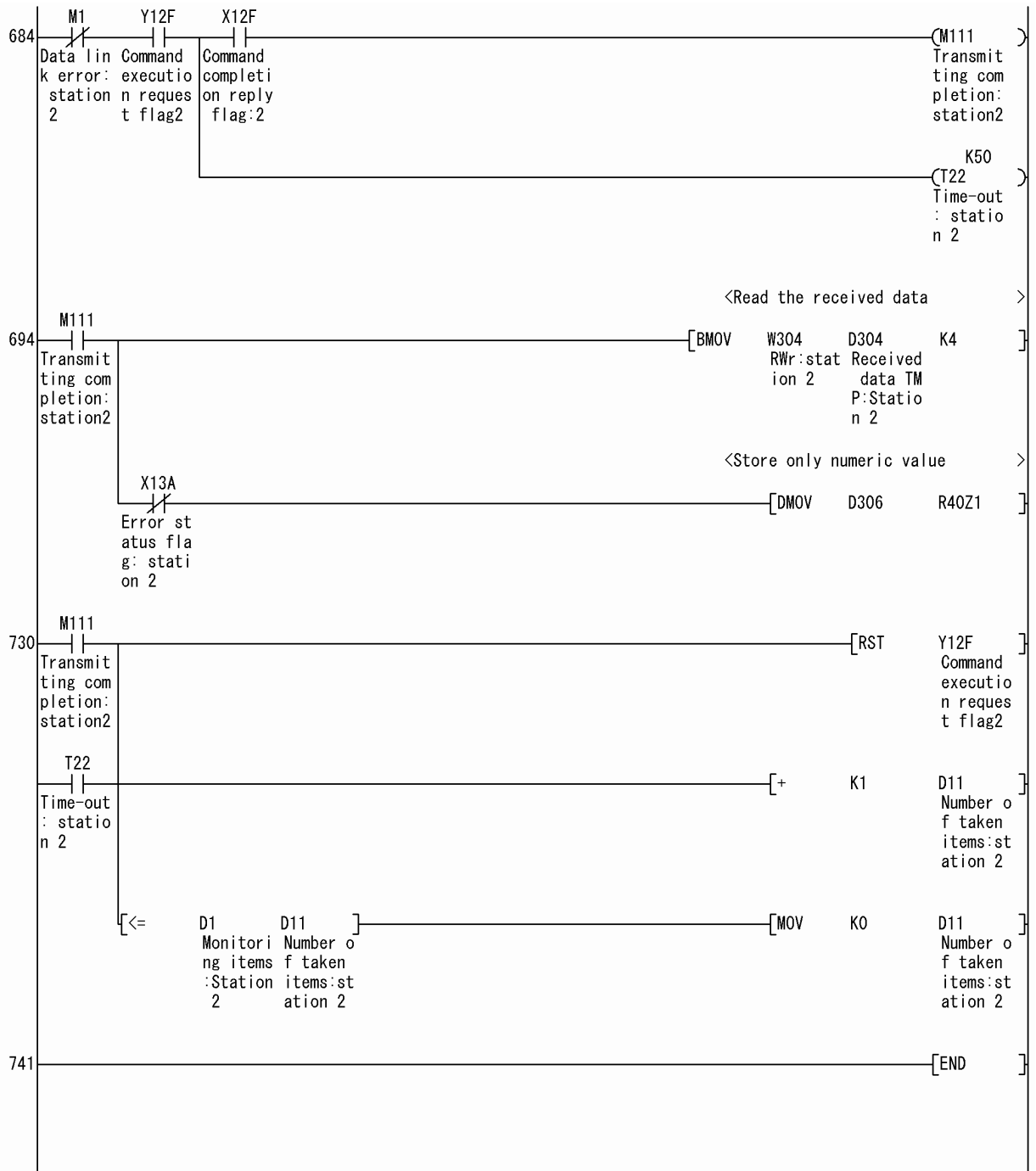

9. Test Function Mode

ME96NSR has the test function mode which the fixed values are replied if there is no input. It can be used to check the communication to PLC.

9.1 How to Test

To do the test, it is necessary to operate the main device.

Operate as follows.

- ① At the state of power failure, turn on the power supply while pressing the DISPLAY of main device.
- ② After display on the right shows up, take the normal communication.
- ③ Data shown in the next section is replied.

When the test is finished, turn off the power supply.

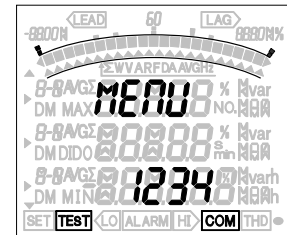

9.2 Reply Data

The reply data at test function mode is shown in the next page or later.

The reply data takes the value of primary side, but the data of table 9.1 is described the secondary side.

It is necessary to convert to the value of primary side using the VT ratio and CT ratio.

(Example) At three phase 3-wire, VT: 6600V/110V, CT: 100A/5A

- Phase 1 current (Inst.) = reply data(secondary side) × CT ratio.
= 4.11A × 100A/5A = 82.2A
- 1-2 voltage (Inst.) = reply data(secondary side) × VT ratio.
= 101.1V × 6600V/110V = 6066V
- Total active power (Inst.) = reply data(secondary side) × VT ratio × CT ratio.
= 1041W × 6600V/110V × 100A/5A = 1249.2kW

Table 9.1 Reply data

Unit No.	Group (h)	Ch. (h)	Name of Channel	Data Type	3P4W reply data (Secondary side)		3P3W_2CT reply data (Secondary side)		3P3W_3CT reply data (Secondary side)		Note
					Data	Unit	Data	Unit	Data	Unit	
0	F0	2	Model code	⑤	—	—	—	—	—	—	
0	E0	11	Primary current	④	—	—	—	—	—	—	
0	E0	12	Primary voltage(L-L)	④	—	—	—	—	—	—	
0	E0	1B	Primary voltage(L-N)	④	—	—	—	—	—	—	
0	E0	1C	Secondary voltage(L-N)	④	—	—	—	—	—	—	
0	E0	13	Phase & Wiring	⑤	—	—	—	—	—	—	
0	E0	18	Alarm Items	⑥	—	—	—	—	—	—	
0	E0	19	Byte monitor	⑤	—	—	—	—	—	—	
0	E0	1A	reserved		—	—	—	—	—	—	
0	2	E0	Time constant for DA sec.	⑤	—	—	—	—	—	—	
0	1	1	Average current A Inst.	①	4.31	A	4.41	A	4.31	A	
0	1	21	Phase 1 current A Inst.	①	4.11	A	4.11	A	4.11	A	
0	1	41	Phase 2 current A Inst.	①	4.21	A	4.51	A	4.21	A	
0	1	61	Phase 3 current A Inst.	①	4.61	A	4.61	A	4.61	A	
0	1	81	Phase N current A Inst.	①	4.51	A	—	—	—	—	
0	1	2	Average current A max.	①	4.32	A	4.42	A	4.32	A	
0	1	22	Phase 1 current A max.	①	4.12	A	4.12	A	4.12	A	
0	1	42	Phase 2 current A max.	①	4.22	A	4.52	A	4.22	A	
0	1	62	Phase 3 current A max.	①	4.62	A	4.62	A	4.62	A	
0	1	82	Phase N current A max.	①	4.52	A	—	—	—	—	
0	1	5	Average current A min.	①	4.30	A	4.40	A	4.30	A	
0	1	25	Phase 1 current A min.	①	4.10	A	4.10	A	4.10	A	
0	1	45	Phase 2 current A min.	①	4.20	A	4.50	A	4.20	A	
0	1	65	Phase 3 current A min.	①	4.60	A	4.60	A	4.60	A	
0	1	85	Phase N current A min.	①	4.50	A	—	—	—	—	
0	2	1	Average current demand A Inst.	①	4.31	A	4.41	A	4.31	A	
0	2	21	Phase 1 current demand A Inst.	①	4.11	A	4.11	A	4.11	A	
0	2	41	Phase 2 current demand A Inst.	①	4.21	A	4.51	A	4.21	A	
0	2	61	Phase 3 current demand A Inst.	①	4.61	A	4.61	A	4.61	A	
0	2	81	Phase N current demand A Inst.	①	4.51	A	—	—	—	—	
0	2	2	Average current demand A max.	①	4.32	A	4.42	A	4.32	A	
0	2	22	Phase 1 current demand A max.	①	4.12	A	4.12	A	4.12	A	
0	2	42	Phase 2 current demand A max.	①	4.22	A	4.52	A	4.22	A	
0	2	62	Phase 3 current demand A max.	①	4.62	A	4.62	A	4.62	A	
0	2	82	Phase N current demand A max.	①	4.52	A	—	—	—	—	
0	2	5	Average current demand A min.	①	4.30	A	4.40	A	4.30	A	
0	2	25	Phase 1 current demand A min.	①	4.10	A	4.10	A	4.10	A	
0	2	45	Phase 2 current demand A min.	①	4.20	A	4.50	A	4.20	A	
0	2	65	Phase 3 current demand A min.	①	4.60	A	4.60	A	4.60	A	
0	2	85	Phase N current demand A min.	①	4.50	A	—	—	—	—	
0	5	1	Average L-L voltage V Inst.	①	173.1	V	127.8	V	127.8	V	
0	5	21	1-2 voltage V Inst.	①	171.1	V	101.1	V	101.1	V	
0	5	41	2-3 voltage V Inst.	①	172.1	V	106.1	V	106.1	V	
0	5	61	3-1 voltage V Inst.	①	176.1	V	176.1	V	176.1	V	
0	5	2	Average L-L voltage V max.	①	173.2	V	127.9	V	127.9	V	
0	5	22	1-2 voltage V max.	①	171.2	V	101.2	V	101.2	V	
0	5	42	2-3 voltage V max.	①	172.2	V	106.2	V	106.2	V	
0	5	62	3-1 voltage V max.	①	176.2	V	176.2	V	176.2	V	
0	5	5	Average L-L voltage V min.	①	173.0	V	127.7	V	127.7	V	
0	5	25	1-2 voltage V min.	①	171.0	V	101.0	V	101.0	V	
0	5	45	2-3 voltage V min.	①	172.0	V	106.0	V	106.0	V	
0	5	65	3-1 voltage V min.	①	176.0	V	176.0	V	176.0	V	

Unit No.	Group (h)	Ch. (h)	Name of Channel			Data Type	3P4W reply data (Secondary side)		3P3W_2CT reply data (Secondary side)		3P3W_3CT reply data (Secondary side)		Note
							Data	Unit	Data	Unit	Data	Unit	
0	3	1	Average L-N voltage	V	Inst.	①	103.1	V	—	—	—	—	
0	3	21	1-N voltage	V	Inst.	①	101.1	V	—	—	—	—	
0	3	41	2-N voltage	V	Inst.	①	102.1	V	—	—	—	—	
0	3	61	3-N voltage	V	Inst.	①	106.1	V	—	—	—	—	
0	3	2	Average L-N voltage	V	max.	①	103.2	V	—	—	—	—	
0	3	22	1-N voltage	V	max.	①	101.2	V	—	—	—	—	
0	3	42	2-N voltage	V	max.	①	102.2	V	—	—	—	—	
0	3	62	3-N voltage	V	max.	①	106.2	V	—	—	—	—	
0	3	5	Average L-N voltage	V	min.	①	103.0	V	—	—	—	—	
0	3	25	1-N voltage	V	min.	①	101.0	V	—	—	—	—	
0	3	45	2-N voltage	V	min.	①	102.0	V	—	—	—	—	
0	3	65	3-N voltage	V	min.	①	106.0	V	—	—	—	—	
0	7	1	Total active power	kW	Inst.	①	1041	W	1041	W	1041	W	
0	7	21	Phase 1 active power	kW	Inst.	①	1011	W	—	—	—	—	
0	7	41	Phase 2 active power	kW	Inst.	①	1021	W	—	—	—	—	
0	7	61	Phase 3 active power	kW	Inst.	①	1031	W	—	—	—	—	
0	7	2	Total active power	kW	max.	①	1042	W	1042	W	1042	W	
0	7	22	Phase 1 active power	kW	max.	①	1012	W	—	—	—	—	
0	7	42	Phase 2 active power	kW	max.	①	1022	W	—	—	—	—	
0	7	62	Phase 3 active power	kW	max.	①	1032	W	—	—	—	—	
0	7	5	Total active power	kW	min.	①	1040	W	1040	W	1040	W	
0	7	25	Phase 1 active power	kW	min.	①	1010	W	—	—	—	—	
0	7	45	Phase 2 active power	kW	min.	①	1020	W	—	—	—	—	
0	7	65	Phase 3 active power	kW	min.	①	1030	W	—	—	—	—	
0	9	1	Total reactive power	kvar	Inst.	①	741	var	741	var	741	var	
0	9	21	Phase 1 reactive power	kvar	Inst.	①	711	var	—	—	—	—	
0	9	41	Phase 2 reactive power	kvar	Inst.	①	721	var	—	—	—	—	
0	9	61	Phase 3 reactive power	kvar	Inst.	①	731	var	—	—	—	—	
0	9	2	Total reactive power	kvar	max.	①	742	var	742	var	742	var	
0	9	22	Phase 1 reactive power	kvar	max.	①	712	var	—	—	—	—	
0	9	42	Phase 2 reactive power	kvar	max.	①	722	var	—	—	—	—	
0	9	62	Phase 3 reactive power	kvar	max.	①	732	var	—	—	—	—	
0	9	5	Total reactive power	kvar	min.	①	740	var	740	var	740	var	
0	9	25	Phase 1 reactive power	kvar	min.	①	710	var	—	—	—	—	
0	9	45	Phase 2 reactive power	kvar	min.	①	720	var	—	—	—	—	
0	9	65	Phase 3 reactive power	kvar	min.	①	730	var	—	—	—	—	
1	0B	1	Total apparent power	kVA	Inst.	①	1241	VA	—	—	—	—	
1	0B	21	Phase 1 apparent power	kVA	Inst.	①	1211	VA	—	—	—	—	
1	0B	41	Phase 2 apparent power	kVA	Inst.	①	1221	VA	—	—	—	—	
1	0B	61	Phase 3 apparent power	kVA	Inst.	①	1231	VA	—	—	—	—	
1	0B	2	Total apparent power	kVA	max.	①	1242	VA	—	—	—	—	
1	0B	22	Phase 1 apparent power	kVA	max.	①	1212	VA	—	—	—	—	
1	0B	42	Phase 2 apparent power	kVA	max.	①	1222	VA	—	—	—	—	
1	0B	62	Phase 3 apparent power	kVA	max.	①	1232	VA	—	—	—	—	
1	0B	5	Total apparent power	kVA	min.	①	1240	VA	—	—	—	—	
1	0B	25	Phase 1 apparent power	kVA	min.	①	1210	VA	—	—	—	—	
1	0B	45	Phase 2 apparent power	kVA	min.	①	1220	VA	—	—	—	—	
1	0B	65	Phase 3 apparent power	kVA	min.	①	1230	VA	—	—	—	—	

Unit No.	Group (h)	Ch. (h)	Name of Channel			Data Type	3P4W reply data (Secondary side)		3P3W_2CT reply data (Secondary side)		3P3W_3CT reply data (Secondary side)		Note
							Data	Unit	Data	Unit	Data	Unit	
0	0D	1	Total power factor	%	Inst.	①	84.1	%	84.1	%	84.1	%	
0	0D	21	Phase 1 power factor	%	Inst.	①	81.1	%	—	—	—	—	
0	0D	41	Phase 2 power factor	%	Inst.	①	82.1	%	—	—	—	—	
0	0D	61	Phase 3 power factor	%	Inst.	①	83.1	%	—	—	—	—	
0	0D	2	Total power factor	%	max.	①	84.0	%	84.0	%	84.0	%	
0	0D	22	Phase 1 power factor	%	max.	①	81.0	%	—	—	—	—	
0	0D	42	Phase 2 power factor	%	max.	①	81.9	%	—	—	—	—	
0	0D	62	Phase 3 power factor	%	max.	①	83.0	%	—	—	—	—	
0	0D	5	Total power factor	%	min.	①	84.2	%	84.2	%	84.2	%	
0	0D	25	Phase 1 power factor	%	min.	①	81.2	%	—	—	—	—	
0	0D	45	Phase 2 power factor	%	min.	①	82.2	%	—	—	—	—	
0	0D	65	Phase 3 power factor	%	min.	①	83.2	%	—	—	—	—	
0	0F	1	Frequency	Hz	Inst.	①	50.0	Hz	50.0	Hz	50.0	Hz	
0	0F	2	Frequency	Hz	max.	①	51.0	Hz	51.0	Hz	51.0	Hz	
0	0F	5	Frequency	Hz	min.	①	49.0	Hz	49.0	Hz	49.0	Hz	
0	63	21	1-2 H.V	V	Inst. Total	①	—	—	78.9	V	78.9	V	
0	4D	21	1-2 H.V	V	Inst. 1st	①	—	—	91.1	V	91.1	V	
0	4F	21	1-2 H.V	V	Inst. 3rd	①	—	—	36.1	V	36.1	V	
0	51	21	1-2 H.V	V	Inst. 5th	①	—	—	35.1	V	35.1	V	
0	53	21	1-2 H.V	V	Inst. 7th	①	—	—	34.1	V	34.1	V	
0	55	21	1-2 H.V	V	Inst. 9th	①	—	—	33.1	V	33.1	V	
0	57	21	1-2 H.V	V	Inst. 11th	①	—	—	32.1	V	32.1	V	
0	59	21	1-2 H.V	V	Inst. 13th	①	—	—	20.1	V	20.1	V	
0	76	86	1-2 H.V D. ratio	%	Inst. Total	①	—	—	86.6	%	86.6	%	
0	76	73	1-2 H.V D. ratio	%	Inst. 3rd	①	—	—	39.6	%	39.6	%	
0	76	75	1-2 H.V D. ratio	%	Inst. 5th	①	—	—	38.5	%	38.5	%	
0	76	77	1-2 H.V D. ratio	%	Inst. 7th	①	—	—	37.4	%	37.4	%	
0	76	79	1-2 H.V D. ratio	%	Inst. 9th	①	—	—	36.3	%	36.3	%	
0	76	7B	1-2 H.V D. ratio	%	Inst. 11th	①	—	—	35.2	%	35.2	%	
0	76	7D	1-2 H.V D. ratio	%	Inst. 13th	①	—	—	22.1	%	22.1	%	
0	63	41	2-3 H.V	V	Inst. Total	①	—	—	79.3	V	79.3	V	
0	4D	41	2-3 H.V	V	Inst. 1st	①	—	—	91.3	V	91.3	V	
0	4F	41	2-3 H.V	V	Inst. 3rd	①	—	—	35.9	V	35.9	V	
0	51	41	2-3 H.V	V	Inst. 5th	①	—	—	34.9	V	34.9	V	
0	53	41	2-3 H.V	V	Inst. 7th	①	—	—	34.3	V	34.3	V	
0	55	41	2-3 H.V	V	Inst. 9th	①	—	—	33.3	V	33.3	V	
0	57	41	2-3 H.V	V	Inst. 11th	①	—	—	32.3	V	32.3	V	
0	59	41	2-3 H.V	V	Inst. 13th	①	—	—	21.3	V	21.3	V	
0	76	9C	2-3 H.V D. ratio	%	Inst. Total	①	—	—	86.9	%	86.9	%	
0	76	89	2-3 H.V D. ratio	%	Inst. 3rd	①	—	—	39.3	%	39.3	%	
0	76	8B	2-3 H.V D. ratio	%	Inst. 5th	①	—	—	38.2	%	38.2	%	
0	76	8D	2-3 H.V D. ratio	%	Inst. 7th	①	—	—	37.6	%	37.6	%	
0	76	8F	2-3 H.V D. ratio	%	Inst. 9th	①	—	—	36.5	%	36.5	%	
0	76	91	2-3 H.V D. ratio	%	Inst. 11th	①	—	—	35.4	%	35.4	%	
0	76	93	2-3 H.V D. ratio	%	Inst. 13th	①	—	—	23.3	%	23.3	%	
0	76	DE	L-L H.V D. ratio	%	max. Total	①	—	—	91.7	%	91.7	%	
0	4D	A2	L-L H.V	V	max. 1st	①	—	—	91.8	V	91.8	V	
0	76	CB	L-L H.V D. ratio	%	max. 3rd	①	—	—	40.1	%	40.1	%	
0	76	CD	L-L H.V D. ratio	%	max. 5th	①	—	—	39.1	%	39.1	%	
0	76	CF	L-L H.V D. ratio	%	max. 7th	①	—	—	37.9	%	37.9	%	
0	76	D1	L-L H.V D. ratio	%	max. 9th	①	—	—	36.8	%	36.8	%	
0	76	D3	L-L H.V D. ratio	%	max. 11th	①	—	—	35.7	%	35.7	%	
0	76	D5	L-L H.V D. ratio	%	max. 13th	①	—	—	34.8	%	34.8	%	

Unit No.	Group (h)	Ch. (h)	Name of Channel				Data Type	3P4W reply data (Secondary side)		3P3W_2CT reply data (Secondary side)		3P3W_3CT reply data (Secondary side)		Note
								Data	Unit	Data	Unit	Data	Unit	
0	4B	21	1-N H.V	V	Inst.	Total	①	78.9	V	—	—	—	—	
0	35	21	1-N H.V	V	Inst.	1st	①	91.1	V	—	—	—	—	
1	37	21	1-N H.V	V	Inst.	3rd	①	36.1	V	—	—	—	—	
1	39	21	1-N H.V	V	Inst.	5th	①	35.1	V	—	—	—	—	
1	3B	21	1-N H.V	V	Inst.	7th	①	34.1	V	—	—	—	—	
1	3D	21	1-N H.V	V	Inst.	9th	①	33.1	V	—	—	—	—	
1	3F	21	1-N H.V	V	Inst.	11th	①	32.1	V	—	—	—	—	
1	41	21	1-N H.V	V	Inst.	13th	①	20.1	V	—	—	—	—	
0	77	86	1-N H.V D. ratio	%	Inst.	Total	①	86.6	%	—	—	—	—	
0	77	73	1-N H.V D. ratio	%	Inst.	3rd	①	39.6	%	—	—	—	—	
0	77	75	1-N H.V D. ratio	%	Inst.	5th	①	38.5	%	—	—	—	—	
0	77	77	1-N H.V D. ratio	%	Inst.	7th	①	37.4	%	—	—	—	—	
0	77	79	1-N H.V D. ratio	%	Inst.	9th	①	36.3	%	—	—	—	—	
0	77	7B	1-N H.V D. ratio	%	Inst.	11th	①	35.2	%	—	—	—	—	
0	77	7D	1-N H.V D. ratio	%	Inst.	13th	①	22.1	%	—	—	—	—	
0	4B	41	2-N H.V	V	Inst.	Total	①	73.1	V	—	—	—	—	
0	35	41	2-N H.V	V	Inst.	1st	①	91.2	V	—	—	—	—	
1	37	41	2-N H.V	V	Inst.	3rd	①	36.2	V	—	—	—	—	
1	39	41	2-N H.V	V	Inst.	5th	①	16.8	V	—	—	—	—	
1	3B	41	2-N H.V	V	Inst.	7th	①	34.2	V	—	—	—	—	
1	3D	41	2-N H.V	V	Inst.	9th	①	33.2	V	—	—	—	—	
1	3F	41	2-N H.V	V	Inst.	11th	①	32.2	V	—	—	—	—	
1	41	41	2-N H.V	V	Inst.	13th	①	21.2	V	—	—	—	—	
0	77	9C	2-N H.V D. ratio	%	Inst.	Total	①	80.2	%	—	—	—	—	
0	77	89	2-N H.V D. ratio	%	Inst.	3rd	①	39.7	%	—	—	—	—	
0	77	8B	2-N H.V D. ratio	%	Inst.	5th	①	18.4	%	—	—	—	—	
0	77	8D	2-N H.V D. ratio	%	Inst.	7th	①	37.5	%	—	—	—	—	
0	77	8F	2-N H.V D. ratio	%	Inst.	9th	①	38.4	%	—	—	—	—	
0	77	91	2-N H.V D. ratio	%	Inst.	11th	①	35.3	%	—	—	—	—	
0	77	93	2-N H.V D. ratio	%	Inst.	13th	①	23.2	%	—	—	—	—	
0	4B	61	3-N H.V	V	Inst.	Total	①	79.3	V	—	—	—	—	
0	35	61	3-N H.V	V	Inst.	1st	①	91.3	V	—	—	—	—	
1	37	61	3-N H.V	V	Inst.	3rd	①	35.9	V	—	—	—	—	
1	39	61	3-N H.V	V	Inst.	5th	①	34.9	V	—	—	—	—	
1	3B	61	3-N H.V	V	Inst.	7th	①	34.3	V	—	—	—	—	
1	3D	61	3-N H.V	V	Inst.	9th	①	33.3	V	—	—	—	—	
1	3F	61	3-N H.V	V	Inst.	11th	①	32.3	V	—	—	—	—	
1	41	61	3-N H.V	V	Inst.	13th	①	21.3	V	—	—	—	—	
0	77	B2	3-N H.V D. ratio	%	Inst.	Total	①	86.9	%	—	—	—	—	
0	77	9F	3-N H.V D. ratio	%	Inst.	3rd	①	39.3	%	—	—	—	—	
0	77	A1	3-N H.V D. ratio	%	Inst.	5th	①	38.2	%	—	—	—	—	
0	77	A3	3-N H.V D. ratio	%	Inst.	7th	①	37.6	%	—	—	—	—	
0	77	A5	3-N H.V D. ratio	%	Inst.	9th	①	36.5	%	—	—	—	—	
0	77	A7	3-N H.V D. ratio	%	Inst.	11th	①	35.4	%	—	—	—	—	
0	77	A9	3-N H.V D. ratio	%	Inst.	13th	①	23.3	%	—	—	—	—	
0	77	DE	L-N H.V D. ratio	%	max.	Total	①	91.7	%	—	—	—	—	
0	35	A2	L-N H.V	V	max.	1st	①	91.8	V	—	—	—	—	
0	77	CB	L-N H.V D. ratio	%	max.	3rd	①	40.1	%	—	—	—	—	
0	77	CD	L-N H.V D. ratio	%	max.	5th	①	39.1	%	—	—	—	—	
0	77	CF	L-N H.V D. ratio	%	max.	7th	①	37.9	%	—	—	—	—	
0	77	D1	L-N H.V D. ratio	%	max.	9th	①	36.8	%	—	—	—	—	
0	77	D3	L-N H.V D. ratio	%	max.	11th	①	35.7	%	—	—	—	—	
0	77	D5	L-N H.V D. ratio	%	max.	13th	①	34.6	%	—	—	—	—	

Unit No.	Group (h)	Ch. (h)	Name of Channel				Data Type	3P4W reply data (Secondary side)		3P3W_2CT reply data (Secondary side)		3P3W_3CT reply data (Secondary side)		Note
								Data	Unit	Data	Unit	Data	Unit	
0	33	21	Phase 1 H.A	A	Inst.	Total	①	3.15	A	3.15	A	3.15	A	
0	1D	21	Phase 1 H.A	A	Inst.	1st	①	3.71	A	3.71	A	3.71	A	
0	1F	21	Phase 1 H.A	A	Inst.	3rd	①	1.63	A	1.63	A	1.63	A	
0	21	21	Phase 1 H.A	A	Inst.	5th	①	1.48	A	1.48	A	1.48	A	
0	23	21	Phase 1 H.A	A	Inst.	7th	①	1.34	A	1.34	A	1.34	A	
0	25	21	Phase 1 H.A	A	Inst.	9th	①	1.19	A	1.19	A	1.19	A	
0	27	21	Phase 1 H.A	A	Inst.	11th	①	1.04	A	1.04	A	1.04	A	
0	29	21	Phase 1 H.A	A	Inst.	13th	①	0.89	A	0.89	A	0.89	A	
0	75	86	Phase 1 H.A D. ratio	%	Inst.	Total	①	85.0	%	85.0	%	85.0	%	
1	75	73	Phase 1 H.A D. ratio	%	Inst.	3rd	①	44.0	%	44.0	%	44.0	%	
1	75	75	Phase 1 H.A D. ratio	%	Inst.	5th	①	40.0	%	40.0	%	40.0	%	
1	75	77	Phase 1 H.A D. ratio	%	Inst.	7th	①	36.0	%	36.0	%	36.0	%	
1	75	79	Phase 1 H.A D. ratio	%	Inst.	9th	①	32.0	%	32.0	%	32.0	%	
1	75	7B	Phase 1 H.A D. ratio	%	Inst.	11th	①	28.0	%	28.0	%	28.0	%	
1	75	7D	Phase 1 H.A D. ratio	%	Inst.	13th	①	24.0	%	24.0	%	24.0	%	
0	33	41	Phase 2 H.A	A	Inst.	Total	①	3.07	A	2.92	A	3.07	A	
0	1D	41	Phase 2 H.A	A	Inst.	1st	①	3.72	A	3.75	A	3.72	A	
0	1F	41	Phase 2 H.A	A	Inst.	3rd	①	1.60	A	1.54	A	1.60	A	
0	21	41	Phase 2 H.A	A	Inst.	5th	①	1.45	A	1.39	A	1.45	A	
0	23	41	Phase 2 H.A	A	Inst.	7th	①	1.30	A	1.24	A	1.30	A	
0	25	41	Phase 2 H.A	A	Inst.	9th	①	1.15	A	1.09	A	1.15	A	
0	27	41	Phase 2 H.A	A	Inst.	11th	①	1.00	A	0.94	A	1.00	A	
0	29	41	Phase 2 H.A	A	Inst.	13th	①	0.86	A	0.79	A	0.86	A	
0	75	9C	Phase 2 H.A D. ratio	%	Inst.	Total	①	82.0	%	78.0	%	82.0	%	
1	75	89	Phase 2 H.A D. ratio	%	Inst.	3rd	①	43.0	%	41.0	%	43.0	%	
1	75	8B	Phase 2 H.A D. ratio	%	Inst.	5th	①	39.0	%	37.0	%	39.0	%	
1	75	8D	Phase 2 H.A D. ratio	%	Inst.	7th	①	35.0	%	33.0	%	35.0	%	
1	75	8F	Phase 2 H.A D. ratio	%	Inst.	9th	①	31.0	%	29.0	%	31.0	%	
1	75	91	Phase 2 H.A D. ratio	%	Inst.	11th	①	27.0	%	25.0	%	27.0	%	
1	75	93	Phase 2 H.A D. ratio	%	Inst.	13th	①	23.0	%	21.0	%	23.0	%	
0	33	61	Phase 3 H.A	A	Inst.	Total	①	2.99	A	2.99	A	2.99	A	
0	1D	61	Phase 3 H.A	A	Inst.	1st	①	3.73	A	3.73	A	3.73	A	
0	1F	61	Phase 3 H.A	A	Inst.	3rd	①	1.57	A	1.57	A	1.57	A	
0	21	61	Phase 3 H.A	A	Inst.	5th	①	1.42	A	1.42	A	1.42	A	
0	23	61	Phase 3 H.A	A	Inst.	7th	①	1.27	A	1.27	A	1.27	A	
0	25	61	Phase 3 H.A	A	Inst.	9th	①	1.12	A	1.12	A	1.12	A	
0	27	61	Phase 3 H.A	A	Inst.	11th	①	0.97	A	0.97	A	0.97	A	
0	29	61	Phase 3 H.A	A	Inst.	13th	①	0.82	A	0.82	A	0.82	A	
0	75	B2	Phase 3 H.A D. ratio	%	Inst.	Total	①	80.0	%	80.0	%	80.0	%	
1	75	9F	Phase 3 H.A D. ratio	%	Inst.	3rd	①	42.0	%	42.0	%	42.0	%	
1	75	A1	Phase 3 H.A D. ratio	%	Inst.	5th	①	38.0	%	38.0	%	38.0	%	
1	75	A3	Phase 3 H.A D. ratio	%	Inst.	7th	①	34.0	%	34.0	%	34.0	%	
1	75	A5	Phase 3 H.A D. ratio	%	Inst.	9th	①	30.0	%	30.0	%	30.0	%	
1	75	A7	Phase 3 H.A D. ratio	%	Inst.	11th	①	26.0	%	26.0	%	26.0	%	
1	75	A9	Phase 3 H.A D. ratio	%	Inst.	13th	①	22.0	%	22.0	%	22.0	%	
0	33	81	Phase N H.A	A	Inst.	Total	①	2.92	A	—	—	—	—	
0	1D	81	Phase N H.A	A	Inst.	1st	①	3.75	A	—	—	—	—	
0	1F	81	Phase N H.A	A	Inst.	3rd	①	1.54	A	—	—	—	—	
0	21	81	Phase N H.A	A	Inst.	5th	①	1.39	A	—	—	—	—	
0	23	81	Phase N H.A	A	Inst.	7th	①	1.24	A	—	—	—	—	
0	25	81	Phase N H.A	A	Inst.	9th	①	1.09	A	—	—	—	—	
0	27	81	Phase N H.A	A	Inst.	11th	①	0.94	A	—	—	—	—	
0	29	81	Phase N H.A	A	Inst.	13th	①	0.79	A	—	—	—	—	
0	75	C8	Phase N H.A D. ratio	%	Inst.	Total	①	78.0	%	—	—	—	—	
1	75	B5	Phase N H.A D. ratio	%	Inst.	3rd	①	41.0	%	—	—	—	—	
1	75	B7	Phase N H.A D. ratio	%	Inst.	5th	①	37.0	%	—	—	—	—	
1	75	B9	Phase N H.A D. ratio	%	Inst.	7th	①	33.0	%	—	—	—	—	
1	75	BB	Phase N H.A D. ratio	%	Inst.	9th	①	29.0	%	—	—	—	—	
1	75	BD	Phase N H.A D. ratio	%	Inst.	11th	①	25.0	%	—	—	—	—	
1	75	BF	Phase N H.A D. ratio	%	Inst.	13th	①	21.0	%	—	—	—	—	

Unit No.	Group (h)	Ch. (h)	Name of Channel	Data Type	3P4W reply data (Secondary side)		3P3W_2CT reply data (Secondary side)		3P3W_3CT reply data (Secondary side)		Note			
					Data	Unit	Data	Unit	Data	Unit				
0	33	A2	H.A	A	max.	Total	①	3.48	A	3.48	A	A		
0	1D	A2	H.A	A	max.	1st	①	3.76	A	3.76	A	3.76	A	
0	1F	A2	H.A	A	max.	3rd	①	1.66	A	1.66	A	1.66	A	
0	21	A2	H.A	A	max.	5th	①	1.56	A	1.56	A	1.56	A	
0	23	A2	H.A	A	max.	7th	①	1.46	A	1.46	A	1.46	A	
0	25	A2	H.A	A	max.	9th	①	1.36	A	1.36	A	1.36	A	
0	27	A2	H.A	A	max.	11th	①	1.26	A	1.26	A	1.26	A	
0	29	A2	H.A	A	max.	13th	①	1.16	A	1.16	A	1.16	A	
1	33	82	Phase N H.A	A	max.	Total	①	3.51	A	—	—	—	—	
1	1D	82	Phase N H.A	A	max.	1st	①	3.77	A	—	—	—	—	
1	1F	82	Phase N H.A	A	max.	3rd	①	1.67	A	—	—	—	—	
1	21	82	Phase N H.A	A	max.	5th	①	1.58	A	—	—	—	—	
1	23	82	Phase N H.A	A	max.	7th	①	1.47	A	—	—	—	—	
1	25	82	Phase N H.A	A	max.	9th	①	1.37	A	—	—	—	—	
1	27	82	Phase N H.A	A	max.	11th	①	1.28	A	—	—	—	—	
1	29	82	Phase N H.A	A	max.	13th	①	1.17	A	—	—	—	—	
0	80	1	active energy import	kWh	count		②	6666.66	kWh	6666.66	kWh	6666.66	kWh	Note1
0	80	63	active energy export	kWh	count		②	5555.55	kWh	5555.55	kWh	5555.55	kWh	Note1
0	80	64	active energy import	kWh	count	expand	②	6.66666	kWh	6.66666	kWh	6.66666	kWh	Note1
0	80	65	active energy export	kWh	count	expand	②	5.55555	kWh	5.55555	kWh	5.55555	kWh	Note1
0	81	1	reactive energy import lag	kvar	count		②	4444.44	kvar	4444.44	kvar	4444.44	kvar	Note1
0	81	63	reactive energy export lag	kvar	count		②	3333.33	kvar	3333.33	kvar	3333.33	kvar	Note1
0	81	64	reactive energy import	kvar	count		②	2222.22	kvar	2222.22	kvar	2222.22	kvar	Note1
0	81	65	reactive energy export	kvar	count		②	1111.11	kvar	1111.11	kvar	1111.11	kvar	Note1
0	81	66	reactive energy import lag	kvar	count	expand	②	4.44444	kvar	4.44444	kvar	4.44444	kvar	Note1
0	81	67	reactive energy export lag	kvar	count	expand	②	3.33333	kvar	3.33333	kvar	3.33333	kvar	Note1
0	81	68	reactive energy import	kvar	count	expand	②	2.22222	kvar	2.22222	kvar	2.22222	kvar	Note1
0	81	69	reactive energy export	kvar	count	expand	②	1.11111	kvar	1.11111	kvar	1.11111	kvar	Note1
0	1	14	current upper limit	A	Alarm		①	—	—	—	—	—	—	
0	1	15	current lower limit	A	Alarm		①	—	—	—	—	—	—	
0	1	94	current upper limit	A	Alarm	PhaseN	①	—	—	—	—	—	—	
0	2	14	current demand upper limit	A	Alarm		①	—	—	—	—	—	—	
0	2	15	current demand lower limit	A	Alarm		①	—	—	—	—	—	—	
0	2	94	current demand upper limit	A	Alarm	PhaseN	①	—	—	—	—	—	—	
0	5	14	voltage upper limit (L-L)	V	Alarm		①	—	—	—	—	—	—	
0	5	15	voltage lower limit (L-L)	V	Alarm		①	—	—	—	—	—	—	
0	3	14	voltage upper limit (L-N)	V	Alarm		①	—	—	—	—	—	—	
0	3	15	voltage lower limit (L-N)	V	Alarm		①	—	—	—	—	—	—	
0	7	14	active power upper limit	kW	Alarm		①	—	—	—	—	—	—	
0	7	15	active power lower limit	kW	Alarm		①	—	—	—	—	—	—	
0	9	14	reactive power upper limit	kvar	Alarm		①	—	—	—	—	—	—	
0	9	15	reactive power lower limit	kvar	Alarm		①	—	—	—	—	—	—	
0	0D	14	power factor upper limit	%	Alarm		①	—	—	—	—	—	—	
0	0D	15	power factor lower limit	%	Alarm		①	—	—	—	—	—	—	
0	0F	14	Frequency upper limit	Hz	Alarm		①	—	—	—	—	—	—	
0	0F	15	Frequency lower limit	Hz	Alarm		①	—	—	—	—	—	—	
0	77	E1	H.V(L-N) upper limit	%	Alarm	Total	①	—	—	—	—	—	—	
0	76	E1	H.V(L-L) upper limit	%	Alarm	Total	①	—	—	—	—	—	—	
0	75	E1	H.A upper limit	A	Alarm	Total	①	—	—	—	—	—	—	
0	75	F1	H.A upper limit(Phase N)	A	Alarm	Total	①	—	—	—	—	—	—	
0	A0	31	Alarm state		Alarm		③	Note2	—	Note2	—	Note2	—	
0	A0	35	Alarm state2		Alarm		③	Note3	—	Note3	—	Note3	—	

Note1. Counting values are replied on the values of primary side.

Note2. b21 and b24 become ON(1). b16 to b19 of digital inputs are reflected at the present state.

Note3. b23, b28 to b31 become ON(1).