

GX Configurator-CC Version 1

Operating Manual

mitsubishi

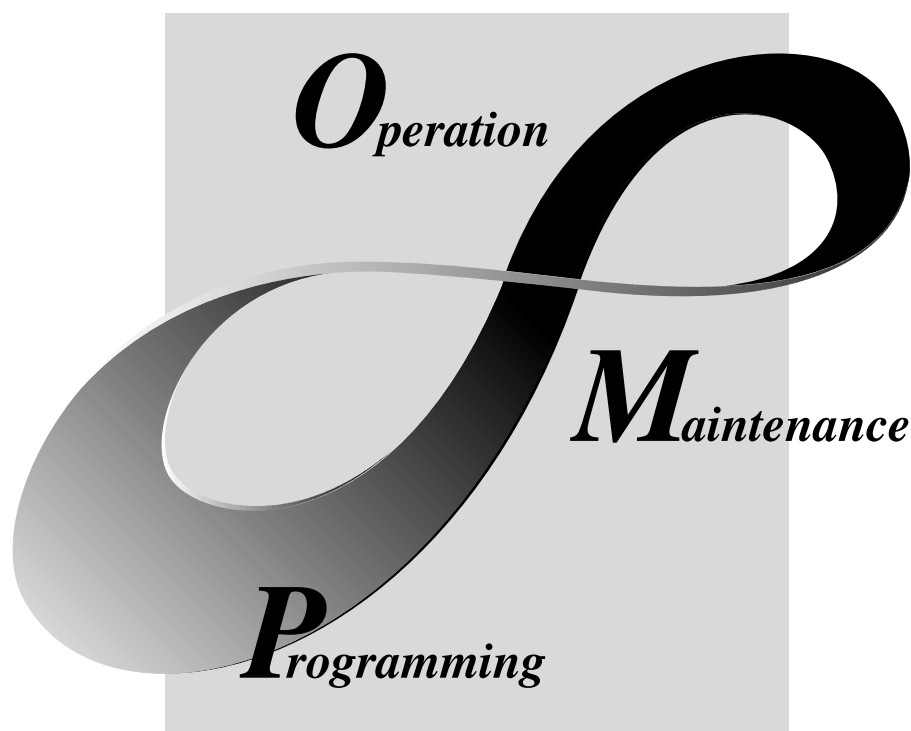

MELSOFT
Integrated FA Software

SW0D5C-J61P-E

• SAFETY PRECAUTIONS •

(Always read these instructions before using this equipment.)

Before using this product, please read this manual and the relevant manuals introduced in this manual carefully and pay full attention to safety to handle the product correctly.

The instructions given in this manual are concerned with this product. For the safety instructions of the programmable controller system, please read the CPU module User's Manual.

In this manual, the safety instructions are ranked as "DANGER" and "CAUTION".



Indicates that incorrect handling may cause hazardous conditions, resulting in death or severe injury.



Indicates that incorrect handling may cause hazardous conditions, resulting in medium or slight personal injury or physical damage.

Note that the  CAUTION level may lead to a serious consequence according to the circumstances. Always follow the instructions of both levels because they are important to personal safety.

Please save this manual to make it accessible when required and always forward it to the end user.

[Design Instructions]

DANGER

- When performing data changes or status control from the peripheral device to the running PLC, configure up an interlock circuit outside the PLC system to ensure that the whole system will operate safely.
In addition, predetermine corrective actions for the system so that you can take measures against any communication error caused by a cable connection fault or the like in online operations performed from the peripheral device to the running PLC.
- Follow the screen instructions when changing a module in remote station changing support operation.
Not doing so can cause the module to fail or malfunction.

[Start-Up/Maintenance Instructions]

CAUTION

- Read the manual carefully before performing the online operation which will be executed with the peripheral device connected to the running module.
Not doing so can damage the machine or cause an accident due to misoperation.

REVISIONS

* The manual number is given on the bottom left of the back cover.

Print Date	* Manual Number	Revision
Apr., 2000	SH (NA)-080103-A	First edition
May, 2001	SH (NA)-080103-B	J61P corrected to be GX Configurator-CC <div style="border: 1px solid black; padding: 2px;">Addition</div> Section 2.2, Section 7.1.1, Section 7.1.2, Section 7.1.3, Section 7.9 <div style="border: 1px solid black; padding: 2px;">Overall correction</div> Chapter 3 <div style="border: 1px solid black; padding: 2px;">Partial correction</div> Related Manuals, About The Generic Terms And Abbreviations, Packing List, Section 1.1, Section 1.2, Section 2.1, Section 2.3, Section 2.4.1, Section 2.4.2, Section 2.5, Chapter 4, Chapter 5, Section 5.1.2, Section 5.1.4, Section 6.1, Section 6.2, Section 7.1, Section 7.2, Section 7.3, Section 7.4, Section 7.5, Section 7.6, Section 7.7, Section 7.7.1, Section 7.7.2, Section 7.7.3, Section 7.8, Section 7.10, Section 7.10.1, Section 7.10.2, Section 7.10.3, Section 7.10.4, Section 7.10.5, Section 7.10.6, Section 8.1, Section 8.2, Section 8.3, Section 8.4, Section 8.6 <div style="border: 1px solid black; padding: 2px;">Deletion</div> Appendix 1
Sep., 2001	SH (NA)-080103-C	<div style="border: 1px solid black; padding: 2px;">Partial correction</div> CONTENTS, Section 3.1.1, Section 3.1.2, Section 3.2.2
Feb., 2003	SH (NA)-080103-D	<div style="border: 1px solid black; padding: 2px;">Partial correction</div> Section 2.1, Section 2.3, Section 3.1.2, Section 3.2.2, Section 3.3, Section 3.4

Japanese Manual Version IB-0800058-D

This manual confers no industrial property rights or any rights of any other kind, nor does it confer any patent licenses. Mitsubishi Electric Corporation cannot be held responsible for any problems involving industrial property rights which may occur as a result of using the contents noted in this manual.

© 2000 MITSUBISHI ELECTRIC CORPORATION

INTRODUCTION

Thank you for choosing the Mitsubishi MELSOFT Series Integrated FA software.
Read this manual and make sure you understand the functions and performance of MELSEC series PLC thoroughly in advance to ensure correct use.

CONTENTS

SAFETY PRECAUTIONS.....	A- 1
REVISIONS.....	A- 2
INTRODUCTION.....	A- 3
CONTENTS.....	A- 3
ABOUT MANUALS.....	A- 6
HOW TO USE THIS MANUAL.....	A- 7
ABOUT THE GENERIC TERMS AND ABBREVIATIONS.....	A- 8
MEANINGS AND DEFINITIONS OF TERMS.....	A- 9
PACKING LIST.....	A-10
1 OVERVIEW	1- 1 to 1-10
1.1 Features.....	1- 1
1.2 Function List.....	1- 4
1.3 Basic Screen Operations.....	1- 8
1.4 Basic Key Specifications.....	1-10
2 SYSTEM CONFIGURATION	2- 1 to 2- 6
2.1 Connection from the Serial Port.....	2- 1
2.2 Connection from the Interface Boards.....	2- 3
2.3 Operating Environment.....	2- 4
2.4 Usable Modules.....	2- 5
2.4.1 PLC CPUs.....	2- 5
2.4.2 Master and local modules.....	2- 5
2.5 Instructions for Use.....	2- 5
3 INSTALLATION AND UNINSTALLATION	3- 1 to 3-14
3.1 Installation.....	3- 1
3.1.1 Installation procedure.....	3- 1
3.1.2 Installing operation.....	3- 2
3.2 Uninstallation.....	3- 6
3.2.1 Uninstallation procedure.....	3- 6
3.2.2 Uninstalling operation.....	3- 7
3.3 Starting and Ending GX Configurator-CC.....	3- 9
3.4 Installing the USB Driver.....	3-10
4 OPERATION PROCEDURES	4- 1 to 4- 3

5 SETTING THE MASTER PARAMETERS (AJ61BT11, A1SJ61BT11 ONLY)	5- 1 to 5-14
--	---------------------

5.1 File Operations.....	5- 1
5.1.1 Creating a new master parameter file	5- 1
5.1.2 Opening the existing master parameter file	5- 2
5.1.3 Closing the master parameter file being edited.....	5- 3
5.1.4 Saving the master parameters being edited	5- 4
5.2 Editing the Master Parameters	5- 6
5.2.1 Setting the detailed information of the master parameters.....	5- 6
5.2.2 Inserting a remote station	5- 8
5.2.3 Deleting the remote station	5-10
5.2.4 Setting remote station information.....	5-11
5.2.5 Cutting/copying/pasting the remote station	5-13
5.3 Checking the Set Master Parameters	5-14

6 SETTING THE REMOTE PARAMETERS	6- 1 to 6- 8
--	---------------------

6.1 Creating a New Remote Parameter File	6- 1
6.2 Opening the Existing Remote Parameter File.....	6- 8

7 ONLINE OPERATIONS	7- 1 to 7-66
----------------------------	---------------------

7.1 Specifying the Connection Target	7- 1
7.1.1 When accessing the own station	7- 3
7.1.2 When accessing the other station	7- 6
7.1.3 Accessing multiple CPUs.....	7-13
7.1.3 (1) About access to other multiple CPU modules	7-13
7.1.3 (2) About network access via multiple CPUs	7-15
7.2 Reading the Parameters from the Master Module (AJ61BT11, A1SJ61BT11 only)	7-19
7.3 Writing the Parameters to the Master Module (AJ61BT11, A1SJ61BT11 only).....	7-20
7.4 Verifying the Parameters between Master Module and GX Configurator-CC (AJ61BT11, A1SJ61BT11 only)	7-21
7.5 Reading the Version of the Master Module.....	7-22
7.6 Monitoring/Testing RX, RY, RWw and RWr of a Remote Station.....	7-23
7.6.1 Performing batch monitor/test.....	7-25
7.6.2 Performing operational tests	7-27
7.7 Monitoring/Testing the Communication Status of CC-Link (When using AJ61BT11 or A1SJ61BT11)	7-36
7.7.1 Monitoring the network status	7-36
7.7.2 Monitoring the devices, LEDs and switches.....	7-38
7.7.3 Conducting the network/line test.....	7-49
7.8 Setting a Remote Station as Temporary Error Invalid Station (AJ61BT11, A1SJ61BT11 only).....	7-51
7.9 Monitoring/Testing the Communication Status of CC-Link (When using AJ61QBT11, A1SJ61QBT11 or QJ61BT11)	7-53
7.9.1 Monitoring the host station.....	7-53
7.9.2 Monitoring the other stations.....	7-55
7.9.3 Conducting a line test.....	7-57

7.10 Setting the R2 Buffer Memory (AJ61BT11, A1SJ61BT11 only).....	7-59
7.10.1 Setting the R2 to be connected	7-59
7.10.2 Performing operation for the initial setting area	7-60
7.10.3 Reading the setting status/communication status storage area.....	7-62
7.10.4 Reading the user free area	7-63
7.10.5 Reading/registering/deleting the user registration frame.....	7-64
7.10.6 Monitoring the I/O data (RX, RY).....	7-66

8 OTHER OPERATIONS	8- 1 to 8-10
---------------------------	---------------------

8.1 Setting the Master Parameters Automatically (Master Parameter Creation Wizard) (AJ61BT11, A1SJ61BT11 only)	8- 1
8.2 Registering/Deleting the Remote Station Type.....	8- 3
8.3 Printing (AJ61BT11, A1SJ61BT11 only).....	8- 6
8.4 Setting the Printer (AJ61BT11, A1SJ61BT11 only).....	8- 9
8.5 Setting Whether the Toolbar and/or Status Bar Is Displayed or Hidden.....	8-10
8.6 Listing the Refresh Addresses of RX, RY or Others (AJ61BT11, A1SJ61BT11 only)	8-10

ABOUT MANUALS

The following manuals are also related to this product.
 In necessary, order them by quoting the details in the tables below.

Related Manuals

Manual Name	Manual Number (Model Code)
Control & Communication Link System Master/Local Module type AJ61BT11/A1SJ61BT11 User's Manual Describes the system configuration, performance specifications, functions, handling, wiring and troubleshooting of the AJ61BT11 and A1SJ61BT11. (Sold separately)	IB(NA)-66721 13J872
Control & Communication Link System Master/Local Module type AJ61QBT11/ A1SJ61QBT11 User's Manual Describes the system configuration, performance specifications, functions, handling, wiring and troubleshooting of the AJ61QBT11 and A1SJ61QBT11. (Sold separately)	IB(NA)-66722 13J873
Control & Communication Link System Master/Local Module User's Manual QJ61BT11 Describes the system configuration, performance specifications, functions, handling, wiring and troubleshooting of the QJ61BT11.	SH(NA)-080016 13JL91
RS-232C Interface Module type AJ65BT-R2 User's Manual Describes the features, system configuration, functions, program examples and troubleshooting of the AJ65BT-R2. (Sold separately)	IB(NA)-66781 13JL24

HOW TO USE THIS MANUAL

"HOW TO USE THIS MANUAL" is given purpose-by-purpose for use of GX Configurator-CC. Refer to the following outlines and use this manual.

- (1) When you want to know the features and function list (Sections 1.1, 1.2)
Features are given in Section 1.1, and the function list in Section 1.2.
- (2) When you want to know the system configuration (Section 2.1, 2.2)
This section provides the system configuration using GX Configurator-CC.
- (3) When you want to know the operating environment and usable modules of GX Configurator-CC (Sections 2.3, 2.4)
The operating environment of GX Configurator-CC is indicated in Section 2.3, and usable modules in Section 2.4.
- (4) When you will install or uninstall GX Configurator-CC (Chapter 3)
Read Chapter 3 which gives how to install and uninstall GX Configurator-CC.
- (5) When you want to know the operating procedures of GX Configurator-CC (Chapter 4)
Chapter 4 provides the operating procedures of GX Configurator-CC.
- (6) When you want to know how to operate GX Configurator-CC (Chapters 5 to 8)
Chapters 5 to 8 provides how to operate GX Configurator-CC.
Read these chapters when using GX Configurator-CC.

ABOUT THE GENERIC TERMS AND ABBREVIATIONS

Unless otherwise specified, the following generic terms and abbreviations are used in this manual to describe GX Configurator-CC Version 1.

Generic Term/Abbreviation	Description
GX Configurator-CC	Abbreviation of GX Configurator-CC Version 1
Personal computer	IBM PC/AT or its compatible personal computer
R2	Abbreviation of the Type AJ65BT-R2 RS-232C interface module
CC-Link	Abbreviation of Control & Communication Link
Remote station	Generic term of remote I/O, remote device, local and intelligent device stations

MEANINGS AND DEFINITIONS OF TERMS

The terms used in this manual have the following meanings and definitions.

(1) Master parameters

Parameters used to set the number of modules connected to the master station, the number of retries, the number of stations occupied by a remote station, and others.

(2) Remote parameters

Parameters used to specify the values to be written to RWw of a CC-Link remote station.

The remote parameters can be used to make settings to remote stations having E²PROM, e.g. inverters and AC servos.

In addition, they can be used to perform RWw read/write tests on remote stations which do not have E²PROM, e.g. AJ65BT-64AD and AJ65BT-D62.

(3) CSP file

A CSP file indicates a device profile (CC-Link System Profile) handled by GX Configurator-CC.

One CSP file is basically available for one remote station.

However, some remote stations allow two or more choices in the number of occupied stations.

In this case, different files are available for the set number of occupied stations.

PACKING LIST

GX Configurator-CC Version 1 consists of the following products.

Product	Quantity
GX Configurator-CC Version 1	1
End-user software license agreement	1
Software registration Card	1
License agreement	1

1 OVERVIEW

This manual explains the functions and operating methods of GX Configurator-CC.

1.1 Features

- (1) You can set the master parameters of the A series master module
 - (a) Conventionally, a sequence program was used to set the parameters of the A series master module. Using this package, you can set the parameters easily while looking at the graphical screen.

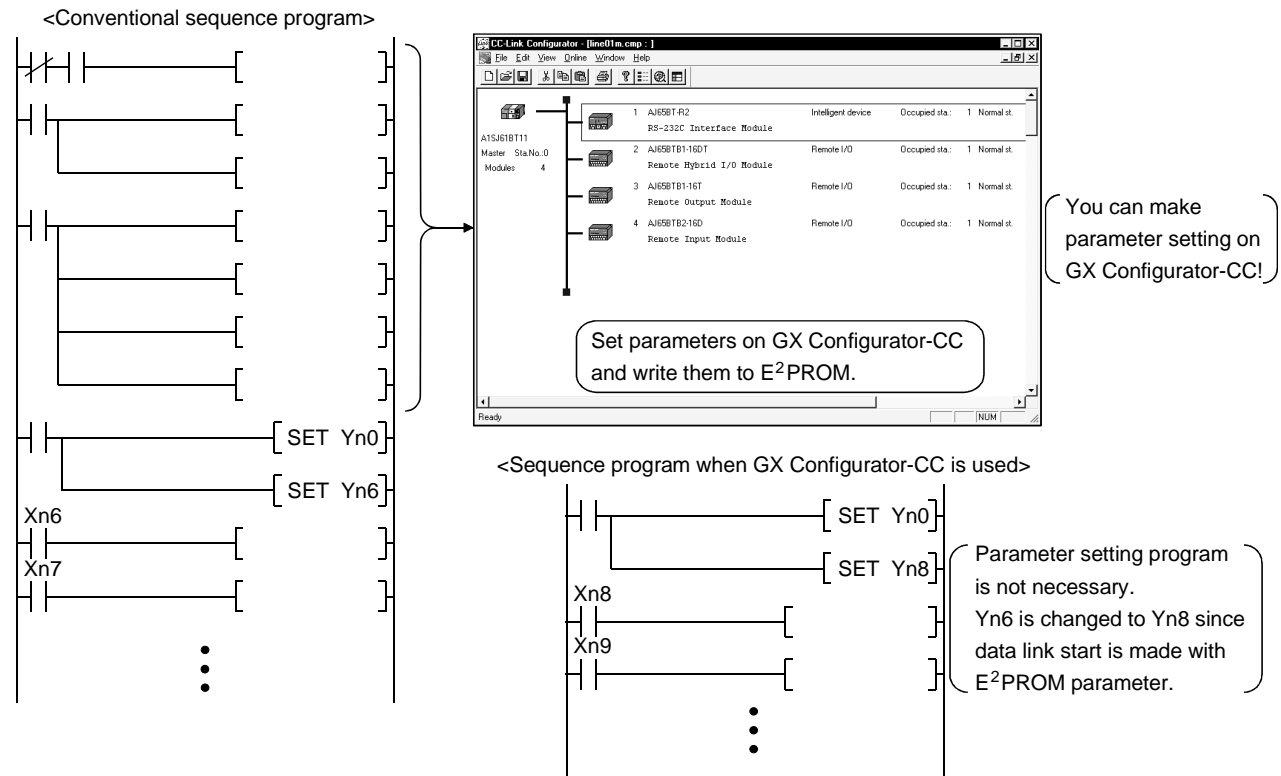

- (b) Using the master parameter creating wizard, you can automatically read the loading status of remote stations and create the number of connected stations and the station information of the connected remote stations in the master parameters.
 - (To use this function, the remote station number settings and cable connections must have been completed to be ready for data link.)

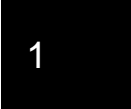

- (2) You can browse and set the remote station parameters
 Using the CSP file available for each equipment, you easily can look at the GX Configurator-CC screen and set and browse the difficult-to-set parameters of a remote station, e.g. inverter, AC servo.

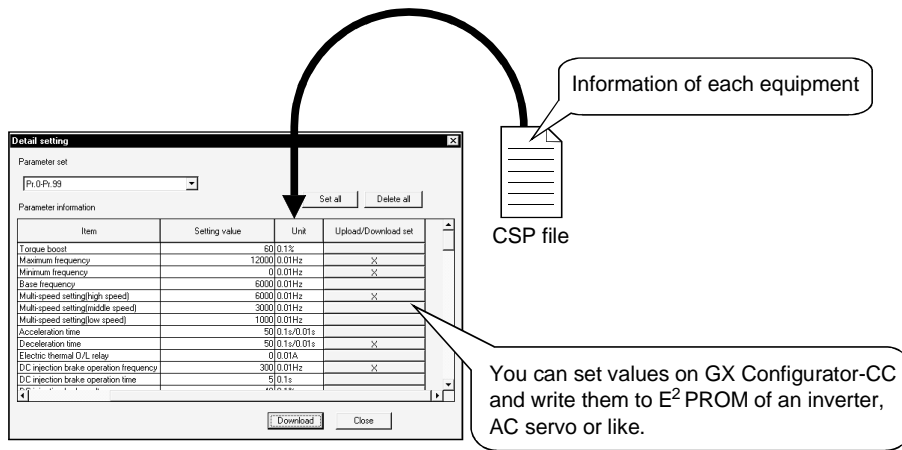

- (3) You can set AJ65BT-R2 buffer memory
 You can set the AJ65BT-R2 buffer memory from GX Configurator-CC. With this function, writing the initial values from GX Configurator-CC to buffer memory and then registering them to E²PROM as buffer memory initial values makes it unnecessary to write the initial setting program of the AJ65BT-R2, which is cumbersome to create. In addition, you can easily register user registration frames.

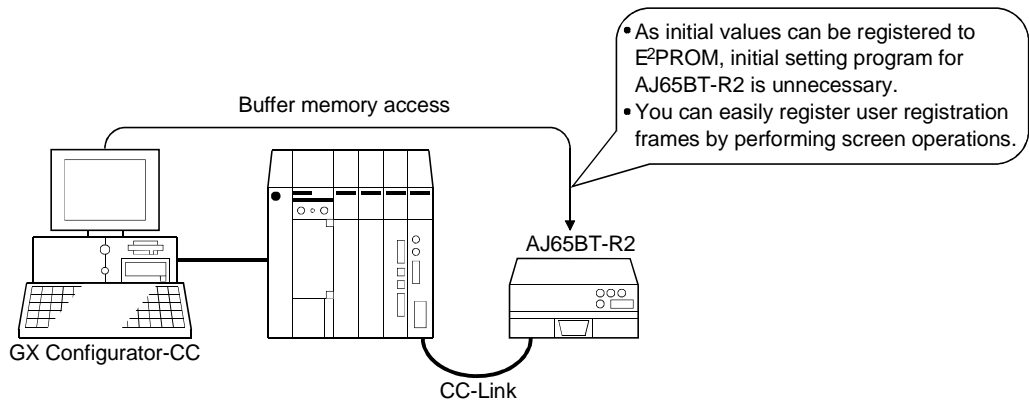

(4) Enhanced diagnostic functions

You can monitor/test RX, RY, RWw and RWr and monitor the station statuses (own station/other stations).

Also, conducting a line test provides a graphical display of station statuses, showing you faulty stations at a glance.

<Other station monitor screen>

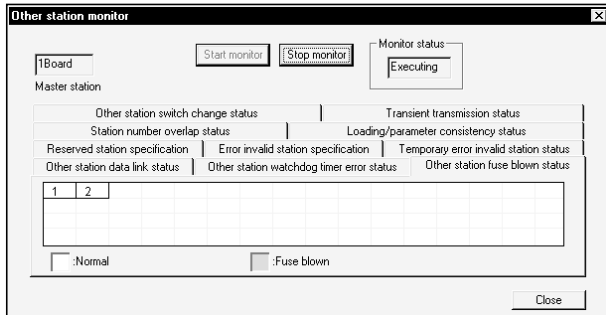

<Line test result screen>

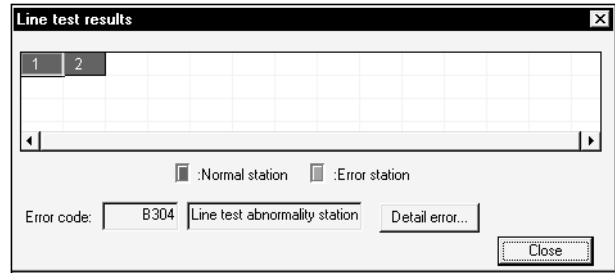

(5) Accessible from various connection forms

Access to the master and remote stations of CC-Link can be made from any of various connection forms, e.g. in direct connection with the PLC CPU, via MELSECNET(II, /B), via MELSECNET/10.

GX Configurator-CC

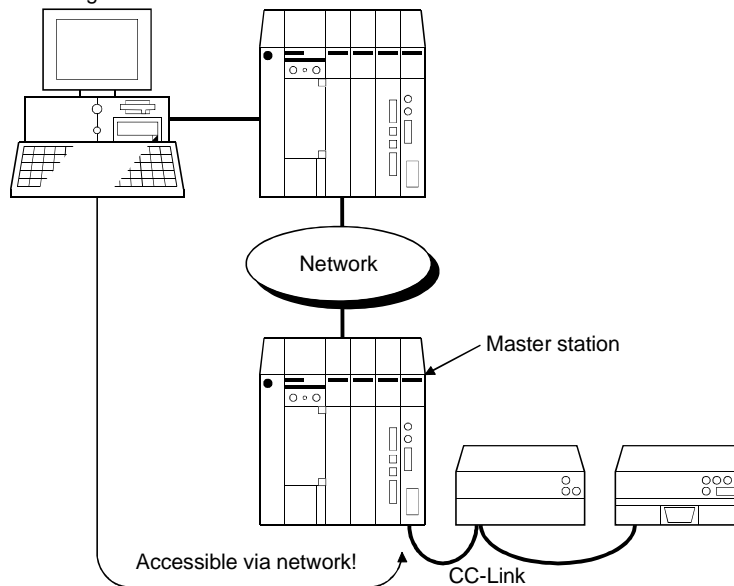

(6) You can monitor/test RX, RY, RWw and RWr

You can monitor and test the RX, RY, RWw and RWr of the specified remote station.

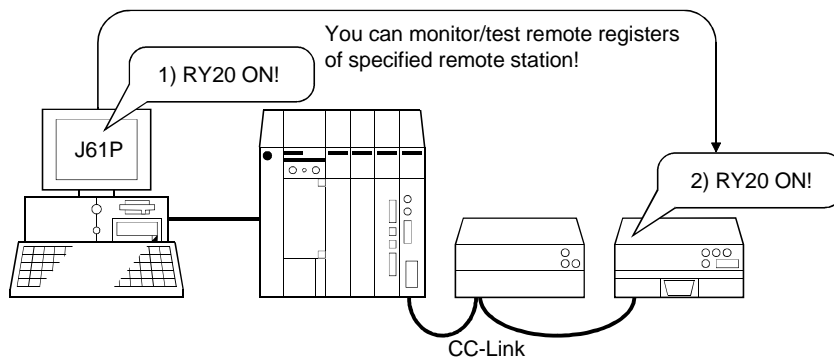





1.2 Function List

The following are the function lists of GX Configurator-CC.



A in the Compatible Master Module field indicates the AJ61BT11 or A1SJ61BT11 and Q/QnA the QJ61BT11, AJ61QBT11 or A1SJ61QBT11.

(1) File menu

Menu Item	Description	Shortcut Key	Icon	Refer To	Compatible Master Module	
					A	Q/QnA
Create <u>N</u> ew master parameter file...	Creates a new master parameter file.	Ctrl+N		Section 5.1.1	○	×
<u>O</u> pen master parameter file...	Opens the existing master parameter file.	Ctrl+O		Section 5.1.2	○	×
<u>C</u> lose master parameter file	Closes the open master parameter file.	—	—	Section 5.1.3	○	×
<u>S</u> ave master parameter	Saves the open master parameter file.	Ctrl+S		Section 5.1.4	○	×
Save master parameter <u>A</u> s...	Saves the open master parameter file with a new name.	Alt+S	—	Section 5.1.4	○	×
<u>C</u> heck master parameter	Checks the master parameters for errors.	Alt+C		Section 5.3	○	×
Master parameter create <u>W</u> izard...	Recognizes the remote stations actually connected to CC-Link and creates the master parameters automatically.	Ctrl+W	—	Section 8.1	○	×
Remote parameter <u>F</u> ile	—	—	—	—	—	—
Create	Creates a new remote parameter file.	Alt+D	—	Section 6.1	○	○
Open remote parameter	Opens the existing remote parameter file.	Ctrl+E	—	Section 6.2	○	○
Registers remote station <u>t</u> ype...	Registers/deletes the remote station type to/from GX Configurator-CC.	Alt+N	—	Section 8.2	○	○
<u>P</u> rint/Print preview...	Prints the connection image or I/O refresh address table.	Ctrl+P		Section 8.3	○	×
Printer <u>s</u> etup...	Sets the printer to be used.	Alt+P	—	Section 8.4	○	×
<u>E</u> xit	Exits from GX Configurator-CC.	—	—	Section 3.3	○	○



○: Compatible, ×: Incompatible

(2) Edit menu

Menu Item	Description	Shortcut Key	Icon	Refer To	Compatible Master Module	
					A	Q/QnA
<u>M</u> aster parameter details...	Sets the master station parameters, such as the number of modules connected, number of retries, and number of automatic return stations.	Ctrl+M	—	Section 5.2.1	○	×
Ed <u>i</u> t remote station...	Edits the first station number, number of occupied stations and others of a remote station.	Ctrl+R	—	Section 5.2.4	○	×
<u>C</u> ut	Cuts the selected remote station.	Ctrl+X		Section 5.2.5	○	×
<u>C</u> opy	Copies the selected remote station.	Ctrl+C		Section 5.2.5	○	×
<u>P</u> aste	Pastes the cut or copied remote station to above the selected remote station.	Ctrl+V		Section 5.2.5	○	×
<u>I</u> nsert remote station	Inserts a remote station in the selected position.	Ctrl+I	—	Section 5.2.2	○	×
<u>D</u> elete remote station	Deletes the selected remote station.	Ctrl+D	—	Section 5.2.3	○	×

○: Compatible, ×: Incompatible

(3) View menu

Menu Item	Description	Shortcut Key	Icon	Refer To	Compatible Master Module	
					A	Q/QnA
<u>I</u> /O refresh address table...	Lists the RX, RY, RWw, RWr, communication buffer or automatic update buffer refresh addresses in the active master parameters.	Alt+I		Section 8.6	○	×
Remote station <u>l</u> ists...	Lists the remote stations registered to GX Configurator-CC. Dragging a remote station adds it to the master parameter.	Alt+L		Section 5.2.2	○	×
<u>T</u> oolbar...	Shows the toolbar.	—	—	Section 8.5	○	○
<u>S</u> tatus bar...	Shows the status bar.	—	—	Section 8.5	○	○

○: Compatible, ×: Incompatible

(4) Online connection menu

Menu Item	Description	Shortcut Key	Icon	Refer To	Compatible Master Module	
					A	Q/QnA
<u>T</u> ransfer setup...	Sets the path from GX Configurator-CC to the module to be accessed.	Alt+T	—	Section 7.1	○	○
<u>U</u> pload master parameter...	Reads the master parameters from the master module.	Alt+U	—	Section 7.2	○	×
<u>D</u> ownload master parameter...	Writes the master parameters to the master module.	Alt+A	—	Section 7.3	○	×
<u>V</u> erify master parameter...	Verifies the master module parameters and GX Configurator-CC master parameters.	Alt+Q	—	Section 7.4	○	×
Master module <u>v</u> ersion information...	Confirms the software version of the master module.	Ctrl+B	—	Section 7.5	○	○
<u>R</u> emote station monitor/test...	Performs monitoring and test of RX, RY, RWw and RWr set to the remote station.	Alt+R	—	Section 7.6	○	○
<u>N</u> etwork <u>m</u> onitor/test	Monitors the LED and switch states of the master and local stations, and performs monitoring and various tests of remote stations.	Alt+M	—	Section 7.7, 7.9	○	○
<u>R</u> emote station exchange support...	Sets the remote station specified online as a temporary error invalid station so that an error in the specified station is not detected.	Alt+X	—	Section 7.8	○	×
AJ65BT-R2 utility	—	—	—	—	—	—
<u>C</u> onnect module set...	Sets the station number and others of R2 to be connected.	—	—	Section 7.10.1	○	×
<u>O</u> perate initial setting area...	Reads or writes data from or to the initial setting area (0H to 19FH) of R2 buffer memory.	—	—	Section 7.10.2	○	×
<u>R</u> ead setting and communication status area	Reads data from the status storing area (1A0H to 1BFH) of R2 buffer memory.	—	—	Section 7.10.3	○	×
<u>R</u> ead user free area...	Reads data from the user free area (200H to 7FFH) of R2 buffer memory.	—	—	Section 7.10.4	○	×
<u>R</u> eading Register and <u>D</u> eleting user registration frame...	Reads, registers or deletes user registration frames.	—	—	Section 7.10.5	○	×
<u>I/O</u> information monitor	Monitors the RX or RY states of R2.	—	—	Section 7.10.6	○	×

○: Compatible, ×: Incompatible

(5) Window menu

Menu Item	Description	Shortcut Key	Icon	Refer To	Compatible Master Module	
					A	Q/QnA
<u>C</u> ascade	Shows open windows overlapped.	—	—	—	○	×
<u>T</u> ile	Shows open windows side by side.	—	—	—	○	×
<u>A</u> rrange icons	Arranges the windows reduced to small icons.	—	—	—	○	×

○: Compatible, ×: Incompatible

(6) Help menu

Menu Item	Description	Shortcut Key	Icon	Refer To	Compatible Master Module	
					A	Q/QnA
PLC <u>e</u> rror	Shows the alarm definitions, causes and corrective actions of various error codes notified by the PLC CPU.	—	—	—	○	○
<u>K</u> ey operation list	Shows the description of the special and shortcut keys of GX Configurator-CC.	Alt+K	—	—	○	○
Product information...	Shows the version and license information of GX Configurator-CC.	—		—	○	○

○: Compatible, ×: Incompatible



1.3 Basic Screen Operations





This section explains basic operations performed on the GX Configurator-CC screens.

The image shows three screenshots of the GX Configurator-CC software interface, each with numbered callouts (1-7) indicating specific UI elements:

- 1** Points to the 'Top station' dropdown menu in the 'Edit remote station' dialog.
- 2** Points to the 'Display switch' buttons (Up, Down) and the 'OK' button in the 'Edit remote station' dialog.
- 3** Points to the 'Type' dropdown menu in the 'Edit remote station' dialog.
- 4** Points to the 'Error invalid station' radio button in the 'Edit remote station' dialog.
- 5** Points to the 'Size of send buffer(bank1)' input field in the 'Edit remote station' dialog.
- 6** Points to the 'Refreshes with the PLC.' checkbox in the 'Remote station monitor/test' dialog.
- 7** Points to the status table in the 'Other station monitor' dialog.

(1) Spin box

You may either enter a value directly or click   to change the value. When entering a value directly, click  and enter a value from the keyboard.

When clicking   to change the value, clicking  increases the value. Clicking  decreases the value.

(2) Command button

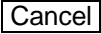
There are such command buttons as  and , and click the button when executing the corresponding item.

(3) List box

Click  to show a choice list, then click the item to be selected.

(4) Radio button

Click  corresponding to the item to be selected.

(5) Text box

Enter characters from the keyboard.

You may either enter only a value or characters into the text box.

(6) Checkbox

















When executing the item, click  to place a check mark .

(7) Tab

To switch , click the portion where the setting item is displayed.

1.4 Basic Key Specifications

The following table gives the applications of the keys used on GX Configurator-CC. The special keys have the specifications for use in the master parameter creation window.

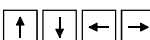
	Key Name	Application
JIS standard key		Used to close a window, suspend execution or choose an instruction.
		Used to enter the TAB code or rapidly move the cursor to change the object to be edited.
		
	+ 	
		Used with the alphanumeric and function keys.
		Used to choose the character in shift position.
		Used to switch between upper- and lower-case characters of alphabets.
		Used to choose a menu item.
		Used to erase a character on the left of the cursor.
		Used to enter a carriage return.
Special key		Used to scroll the screen up one page.
		Used to scroll the screen down one page.
		Used to insert a remote station in the selected position.
		Used to delete a remote station in the selected position.
		Used to move the selected frame to the first remote station.
		Used to move the selected frame to the last remote station.
		Used to use the ten-key pad specifically as numeral keys.
		Used to move the selected frame.

2 SYSTEM CONFIGURATION

This chapter explains the system configuration, operating environment and usable modules.

2.1 Connection from the Serial Port

The following system configuration is made up by connection from the serial port.

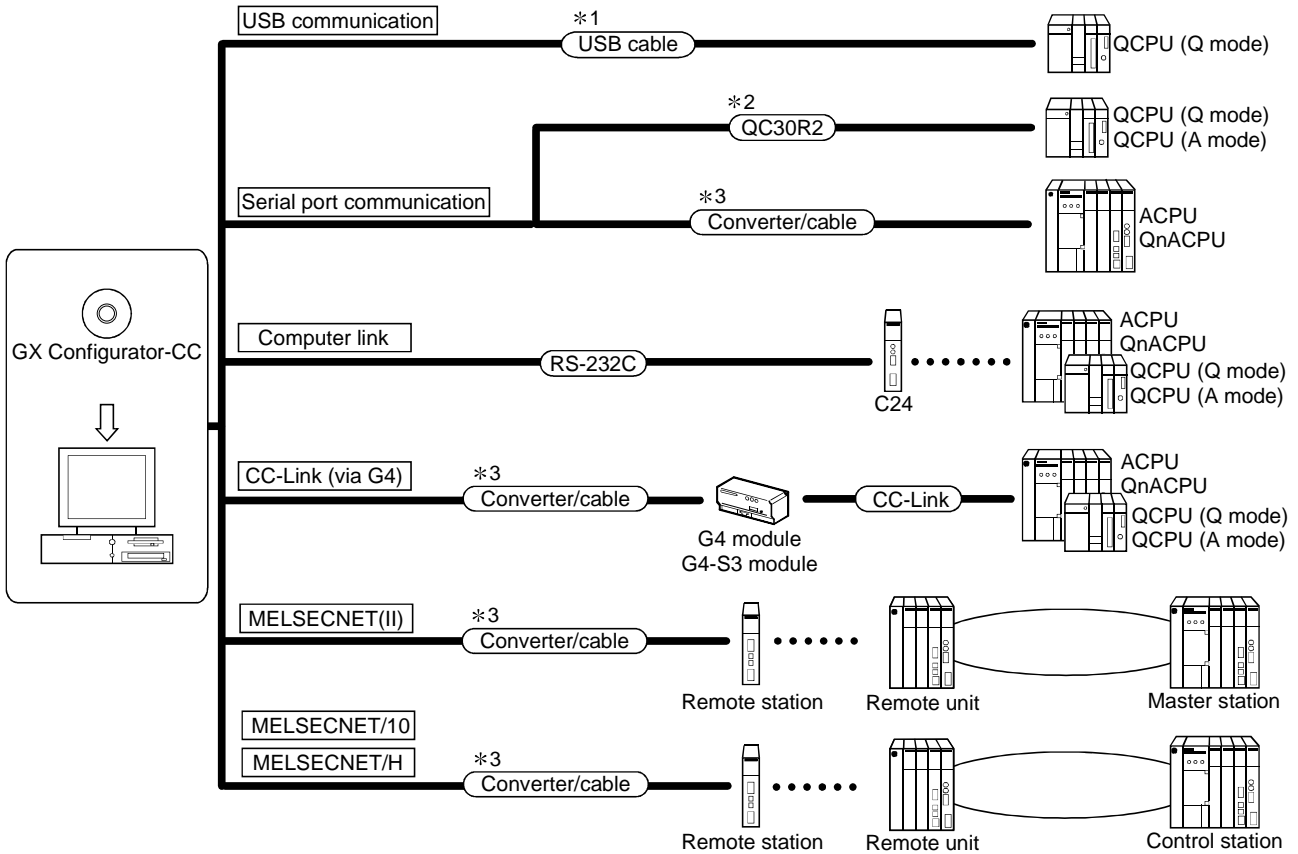

- *1: About the USB cable (QCPU (Q mode) compatible)
- (1) Usable when the USB driver has been installed with any of the following operating systems used.
 - Microsoft® Windows® 98 Operating System
 - Microsoft® Windows® Millennium Edition Operating System
 - Microsoft® Windows® 2000 Professional Operating System
 - Microsoft® Windows® XP Professional Operating System
 - Microsoft® Windows® XP Home Edition Operating System
 - (2) Use of the USB cable allows only one PLC CPU to be connected.
 - (3) Use the USB cable which conforms to the USB Standard Rev. 1.1.
 - (4) Refer to POINT in Section 7.1 (3), (4), (5) for precautions for and restrictions on using the USB cable to make communications.



*2: About the cable (QCPU (Q mode), QCPU (A mode) compatible)
 For communication in 115.2/57.6kbps
 Fast communication cannot be made if the Personal computer used is not compatible with the communication speed of 115.2/57.6kbps.
 If a communication error occurs, reduce the baud rate setting and restart communication.

The following cable has been confirmed by Mitsubishi Electric that it will work properly.

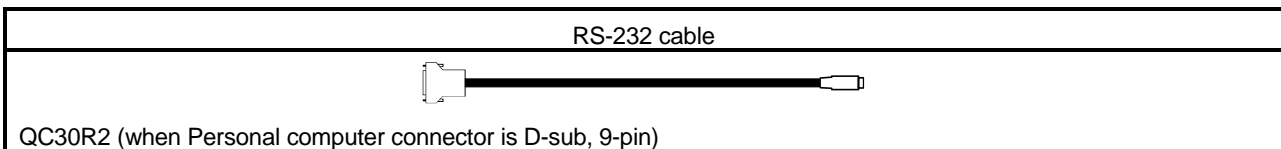
Using the cable of Mitsubishi Electric make



- *3: About the converter/cable (ACPU, QnACPU compatible)
- (1) Using the products of Mitsubishi Electric make

Personal computer Side (RS-232C cable)	RS-232C/RS-422 Converter	PLC CPU Side (RS-422 cable)
 F2-232CAB-1 (when Personal computer connector is D-sub, 9-pin)	 FX-232AW(C)	For ACPU, QnACPU  FX-422CAB (0.3m) FX-422CAB-150 (1.5m)

- How to identify compatibility of the F2-232CAB and F2-232CAB-1 cables with the ACPU and QnACPU

Check the indication of the model label attached to the cable.

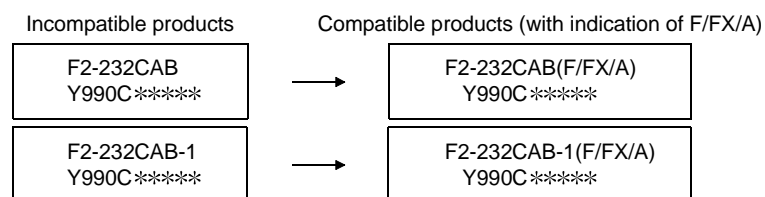

2.2 Connection from the Interface Boards

The following system configuration is made up by connection from the interface boards.

Refer to the corresponding board manuals for the way to connect the boards and install the drivers.

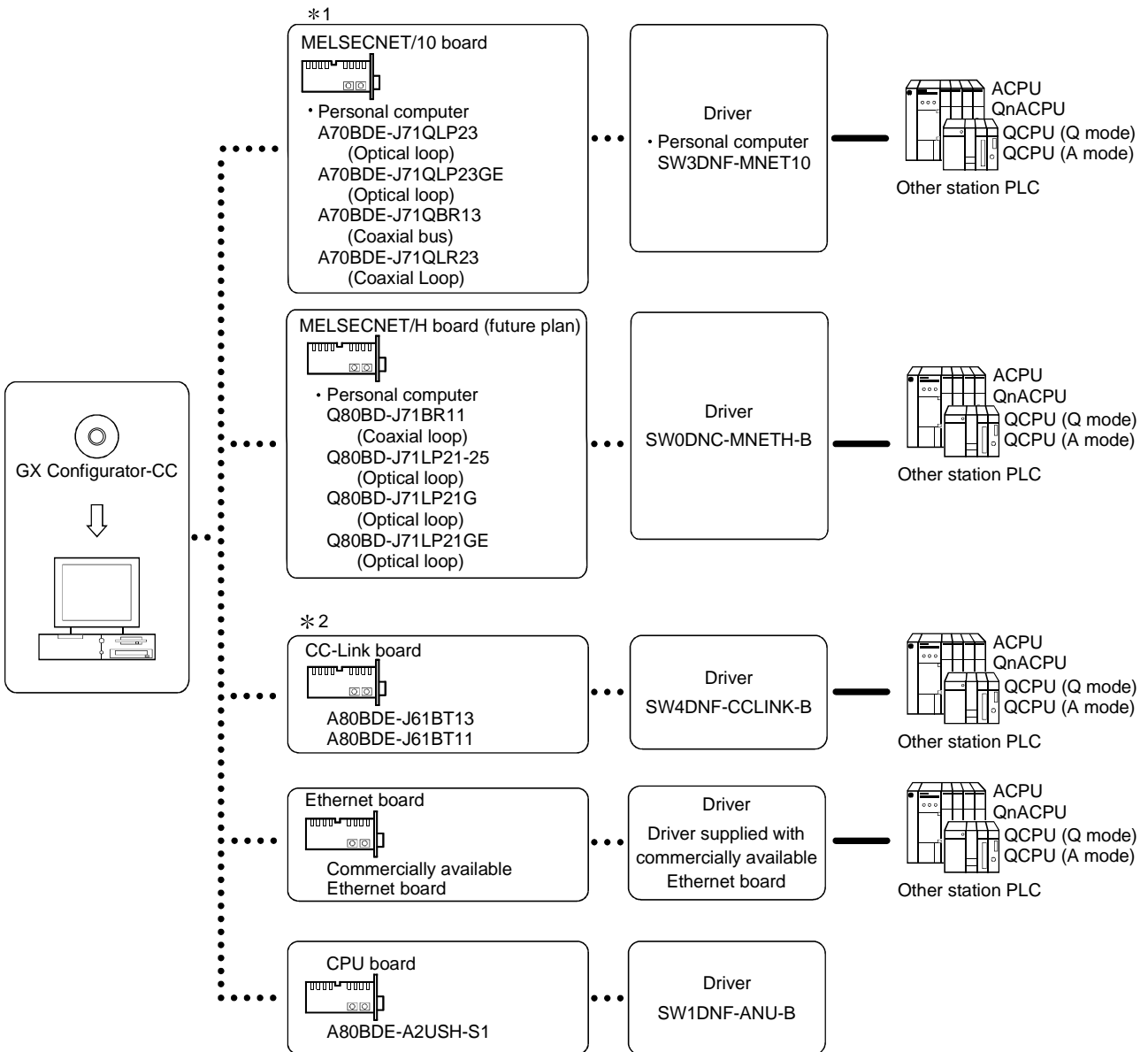

*1: MELSECNET/10 board

The following are the drivers that cannot be used with the operating systems.

Driver Name	Operating Systems
SW3DNF-MNET10	Cannot be used with Windows® Me/2000.
SW0DNC-MNETH-B	Cannot be used with Windows® Me.

If a communications error takes place, an error code is indicated in the least significant 4 digits.

Refer to the error code list of the MELSECNET/10 board manual.

*2: CC-Link board

Accessible only when the CC-Link board is set as the local station.

2.3 Operating Environment

The operating environment of GX Configurator-CC is indicated below.

Item	Description
Peripheral device	Personal computer on which Windows® operates.
Computer main unit	Refer to the following table "Used operating system and performance required for personal computer".
CPU	
Required memory	
Hard disk free space	120MB or more
Disk drive	CD-ROM disk drive
Display	800 × 600 dot or more resolution (Recommended 1024 × 768 dot or more resolution) *
Operating system	Microsoft® Windows® 95 Operating System (English version) Microsoft® Windows® 98 Operating System (English version) Microsoft® Windows® Millennium Edition Operating System (English version) Microsoft® Windows NT® Workstation Operating System Version 4.0 (English version) Microsoft® Windows® 2000 Professional Operating System (English version) Microsoft® Windows® XP Professional Operating System (English version) Microsoft® Windows® XP Home Edition Operating System (English version)

*: When Windows® XP Professional or Windows® XP Home Edition is used, Large Fonts are not supported.

Used operating system and performance required for personal computer

Operating system		Performance Required for Personal Computer	
		CPU	Required memory
Windows® 95		Pentium® 133MHz or more	32MB or more
Windows® 98		Pentium® 133MHz or more	32MB or more
Windows® Me		Pentium® 150MHz or more	32MB or more
Windows NT® Workstation 4.0		Pentium® 133MHz or more	32MB or more
Windows® 2000 Professional		Pentium® 133MHz or more	64MB or more
Windows® XP Professional	"XP compatibility mode" and "Fast User Switching" are not supported.	Pentium® 300MHz or more	128MB or more
Windows® XP Home Edition		Pentium® 300MHz or more	128MB or more

2.4 Usable Modules

The following PLC CPUs and master and local modules are usable.

2.4.1 PLC CPUs

Any of the following CPUs can be connected to GX Configurator-CC to access Control & Communication Link System Master/Local Module.

	PLC CPUs
ACPU	A0J2HCPU, A1SCPU, A1SCPU-S1, A1SCPUC24-R2, A1SHCPU, A1SJCPU, A1SJCPU-S3, A1SJHCPU, A1SJHCPU-S8, A1NCP, A2NCP, A2NCP-S1, A2SCPU, A2SCPU-S1, A2SHCPU, A2SHCPU-S1, A2ACPU, A2ACPU-S1, A2ACPUP21/R21, A2ACPUP21/R21-S1, A3ACPUP21/R21, A2UCPU, A2UCPU-S1, A2ASCPU, A2ASCPU-S1, A2ASCPU-S30, A2USHCPU-S1, A3NCP, A3ACPU, A3UCPU, A4UCPU
QCPU (A mode)	Q02CPU-A, Q02HCPU-A, Q06HCPU-A
QnACPU	Q2ASCPU, Q2ASCPU-S1, Q2ASHCPU, Q2ASCPU-S1, Q2ACPU, Q2ACPU-S1, Q3ACPU, Q4ACPU, Q4ARCPU
QCPU (Q mode)	Q00JCPU, Q00CPU, Q01CPU, Q02CPU, Q02HCPU, Q06HCPU, Q12HCPU, Q25HCPU

2.4.2 Master and local modules

The following master and local modules are usable.

	Master and Local Modules
A series	AJ61BT11, A1SJ61BT11
QnA series	AJ61QBT11, A1SJ61QBT11
Q series	QJ61BT11

2.5 Instructions for Use

When using GX Configurator-CC, note the following points.

- (1) The compatible functions vary with the master module used.
Refer to the function lists in Section 1.2.
- (2) When using GX Configurator-CC via a local station, only the following online functions may be used.
You cannot use the other online functions.
 - Master module version read
 - Network monitor/test
- (3) When data was written to E²PROM of the master module (AJ61BT11, A1SJ61BT11) on GX Configurator-CC, turn on Yn8 to start data link.
When data was written to buffer memory, turn on Yn6 to start data link.
- (4) You cannot set the automatic refresh parameters on GX Configurator-CC.
Use a sequence program or GX Developer to set the automatic refresh parameters.

- (5) When using GX Configurator-CC, set the master parameter for scan mode designation to "asynchronous".
"synchronous" may be used only when the CC-Link-dedicated instruction (RLPA instruction) is used.
- (6) For connection to the QCPU (A mode) or AnUCPU via Ethernet, set the ACPU as the PLC series and "AnN, AnA, AnS, AnSH" as the PLC type. Access can be made to the device memory and like within the range handled by the AnACPU. Therefore, access cannot be made to the devices extended for the QCPU (A mode) or AnUCPU.
However, access to the QCPU (A mode) or AnUCPU via the QJ71E71 can be made within the range handled by the QCPU (A mode) or AnUCPU.
- (7) After boot-up of GX Configurator-CC and GPPW/GPPA for PC9800 series (Windows compatible version), only either PLC communication can be made under the following conditions.
- When using GX Configurator-CC, check whether the COM port of the system (Control Panel) exists or not. Register it if it does not exist. At this time, PLC communication using GPPA/GPPQ cannot be made.
 - When using GPPA/GPPQ, delete the COM port of the system (Control Panel). At this time, PLC communication using GX Configurator-CC cannot be made.
 - After starting of GX Configurator-CC and GX Developer, GX Explorer or like for the A2USHCPU-S1, PLC communication cannot be made.
- (8) During communication, e.g. parameter read from the master module, do not disconnect the cable that connects the personal computer and PLC CPU, and connect it to another PLC CPU.
- (9) Using the same port as used by GPPA or GPPQ disables communication with the PLC. You must use a different port, or quit GPPA or GPPW (also close the DOS prompt) and use the same port.
- (10) When the Windows version of SW NIW-GOT800P or like is used, simultaneous access cannot be made to the same port. Communication can be made with only either one.
- (11) In the following case, access to the QCPU (A mode) cannot be made.
GX Developer AF board or CPU board MELSECNET/10 other station QCPU (A mode)
- (12) Access cannot be made via the MELSECNET II board if the PLC CPU is the AnUCPU.
Choose "AnN, AnA, AnS, AnSH" as the PLC type.

3 INSTALLATION AND UNINSTALLATION

This chapter describes how to install and uninstall GX Configurator-CC.

3.1 Installation

3.1.1 Installation procedure

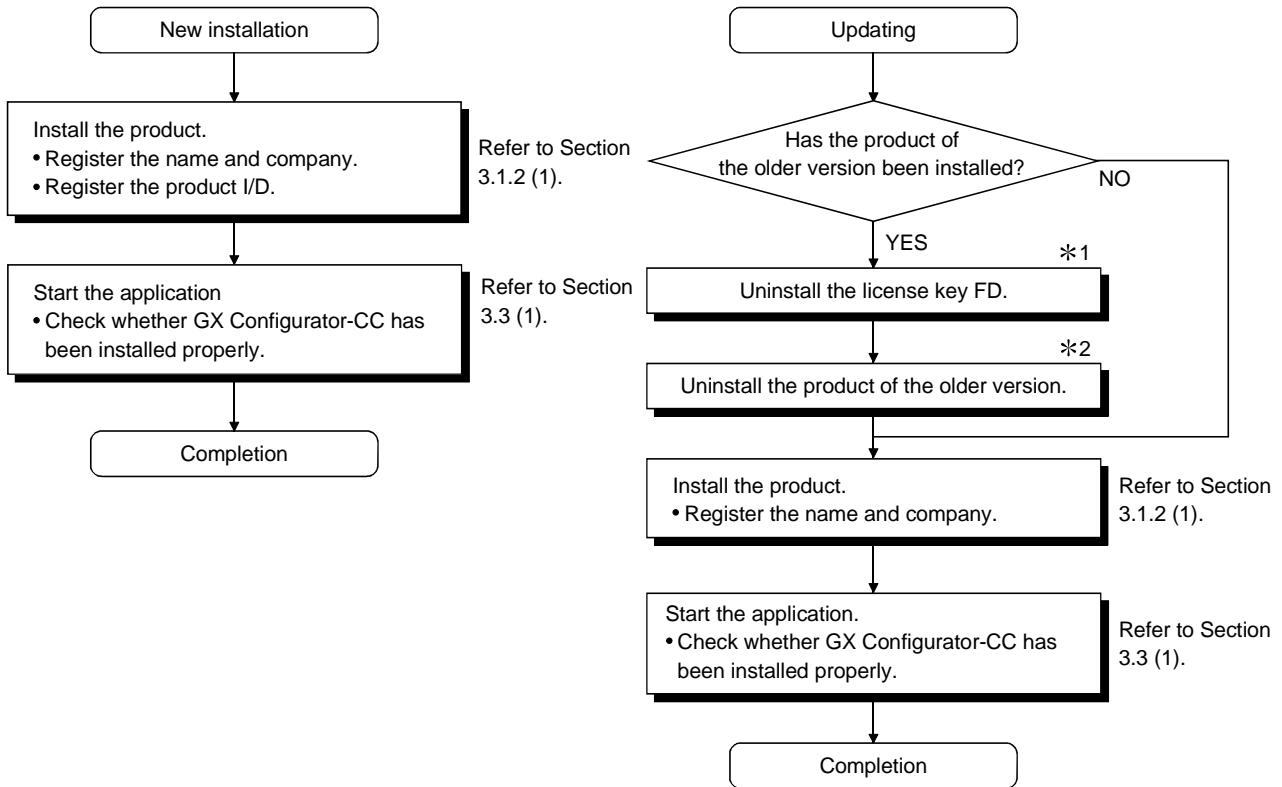

POINTS

- *1: If the license key FD is valid, this product can be installed but the license right is decremented by 1.
- *2: When performing uninstalling operation, refer to the operating manual of the installed product.

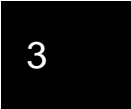

3.1.2 Installing operation

GX Configurator-CC is made usable by installing it.

POINT

- Terminate all the other applications running under Windows® before installation.
- When using Windows® XP Professional, Windows® XP Home Edition, Windows NT® Workstation 4.0 or Windows® 2000 Professional, log on as a user having the administrator attributes (for computer administration).
- If the license key FD is valid, installing this product enables updating.
(The license right of the older version decreases by one.)

3

(1) Installing GX Configurator-CC

1. Power on the personal computer and start Windows® .
2. Insert GX Configurator-CC into the CD-ROM drive and execute "Setup.exe" of the CD-ROM drive using Windows® Explorer or the like.

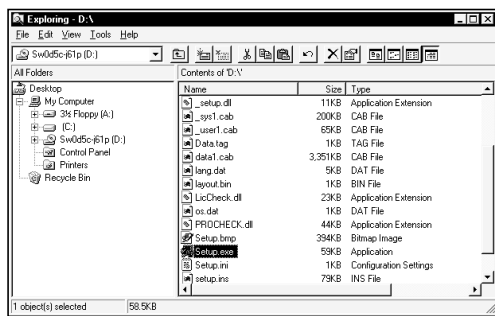

3. If either of the left screens appears, perform operation in accordance with the instructions given in (a) in "(2) When message appears at start of installation".
After the operation is over, restart installation operation.

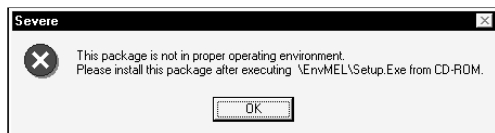
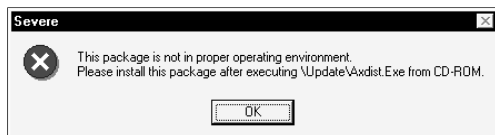
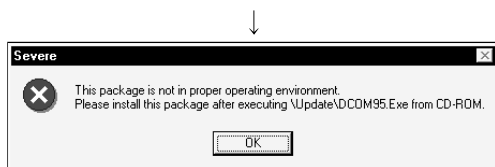

If the left screen appears, perform operation in accordance with the instructions given in (b) in "(2) When message appears at start of installation".
After the operation is over, restart installation operation.

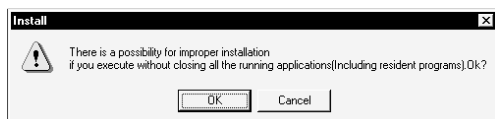

4. After making sure that all applications have been closed, click the "OK" button.
If the applications are running, close all running applications.

(To the next page)

(From the preceding page)

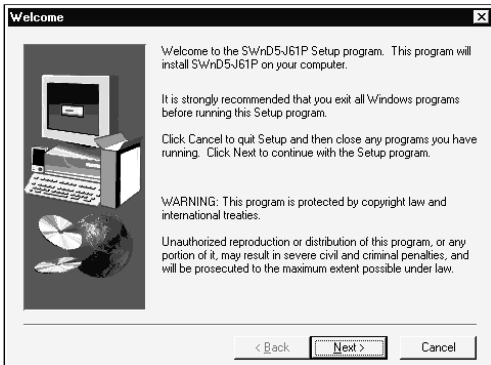

5. Read the information and click the "Next>" button.

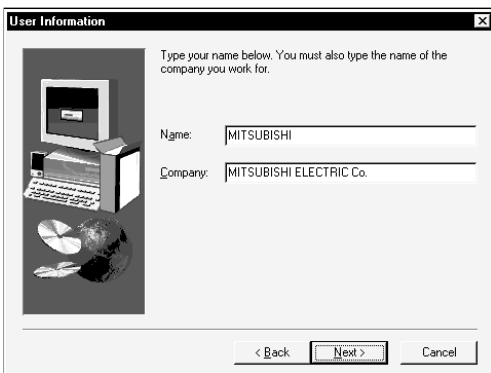

6. Type name and company, and click the "Next>" button.

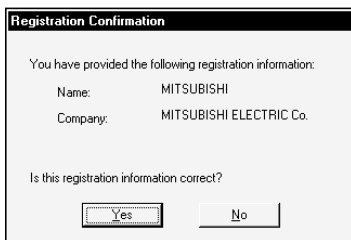

7. Confirm the registered name and company. If they are correct, click the "Yes" button. To make a change, click the "No" button. This returns to the previous screen.

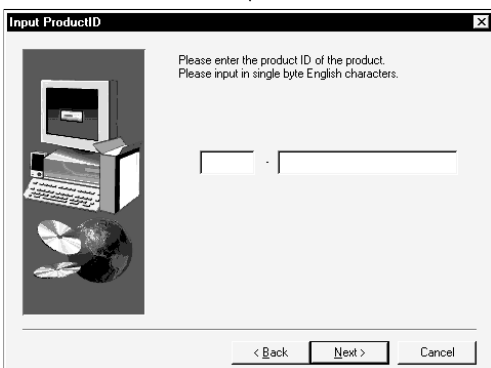

8. Enter the product ID and click the "Next>" button. The product ID is given on the "Software Registration Card" packed with the product.

(To the next page)

(From the preceding page)

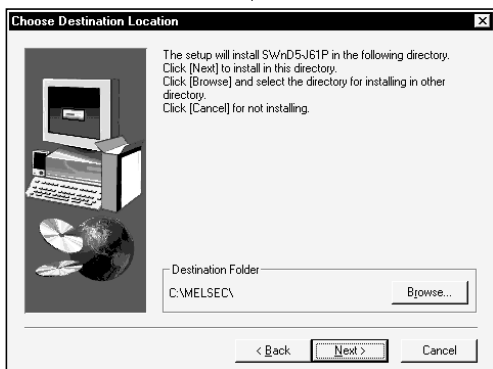

9. Specify the installation destination folder. It defaults to "C:\MELSEC\". If you use the default folder, click the "Next>" button. To change the destination folder, click the "Browse..." button and specify a new folder.

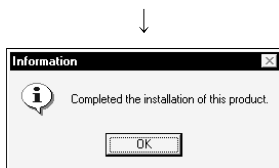

10. This completes installation. Click the **OK** button.

(2) When message appears at start of installation

When the installation of this product starts, the "This package is not in proper operating environment" message appears, disabling normal completion of installation.

In such a case, close all applications and perform the (a) or (b) operation.

(a) Installation of dcom95.exe or Axdist.exe

Execute dcom95.exe or Axdist.exe provided for GX Configurator-CC.
Install GX Configurator-CC after executing the exe file and restarting the IBM-PC/AT compatible.

The exe file to be executed on the corresponding operating system is indicated below.

OS	File name
Microsoft® Windows® 95 Operating System	dcom95.exe
Microsoft® Windows® 98 Operating System	Axdist.exe
Microsoft® Windows NT® Workstation Operating System Version 4.0	Axdist.exe

(dcom95.exe and Axdist.exe are in the "Update" folder on CD-ROM.)

(b) Installation of EnvMEL

Execute Setup.exe in the "EnvMEL" folder on this product CD-ROM.
Install GX Configurator-CC after executing the "Setup exe".

*: After executing the above exe file, install the product again. If this product is not installed properly at this time, reboot the personal computer.

3.2 Uninstallation

This section provides how to uninstall GX Configurator-CC.

3.2.1 Uninstallation procedure

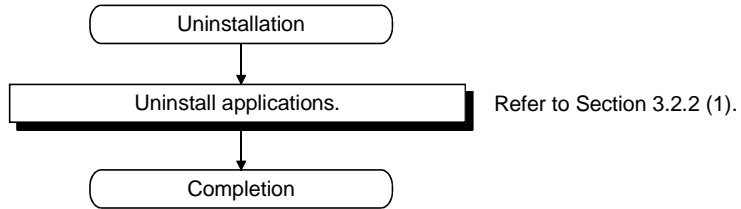

3.2.2 Uninstalling operation

(1) Uninstalling GX Configurator-CC

1. Choose the [Start]—[Settings] — [Control Panel] menu.
2. As the Control Panel appears, double-click "Add/Remove Programs".

REMARKS

When using Windows® XP Professional or Windows® XP Home Edition, choose "Add or Remove Programs" from the Control Panel. To display the Control Panel, choose [Start] - [Control Panel].

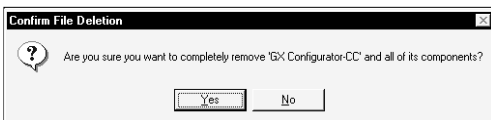
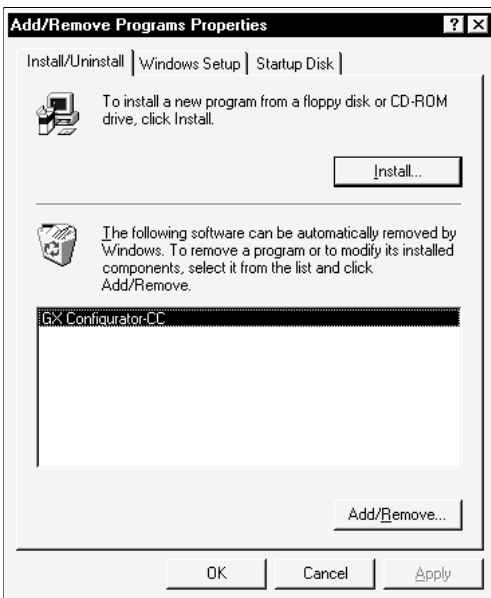
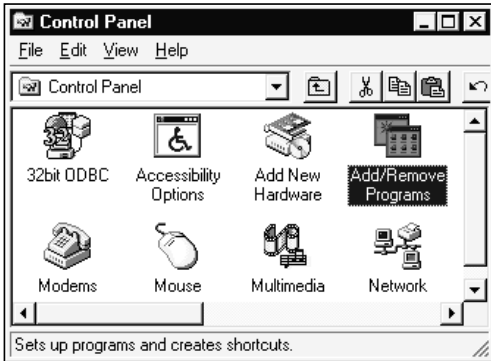

(To the next page)

3. Choose "GX Configurator-CC" and click the "Add/Remove..." button

REMARKS

When using Windows® 2000 Professional, Windows® XP Professional and Windows® XP Home Edition, perform the following operation.
 (a) Click "Add/Remove Programs".
 (b) Choose "GX Configurator-CC".
 (c) Click the "Change/Remove" button.

4. Check whether you will remove the software package or not.
 When uninstalling it, click "Yes".
 Uninstallation starts.
 When not uninstalling it, click "No".
 This returns to the preceding screen.
 * Components indicate the icons and files installed.

(From the preceding page)

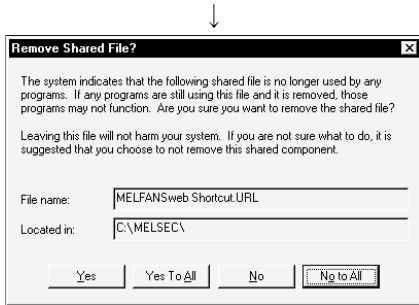

5. If the left screen has appeared, click the "No To All" button.

If you click the "Yes" or "Yes To All" button, the shared file of the Windows® compatible MELSOFT software is removed. Therefore, click the "No To All" button when removing GX Configurator-CC only.

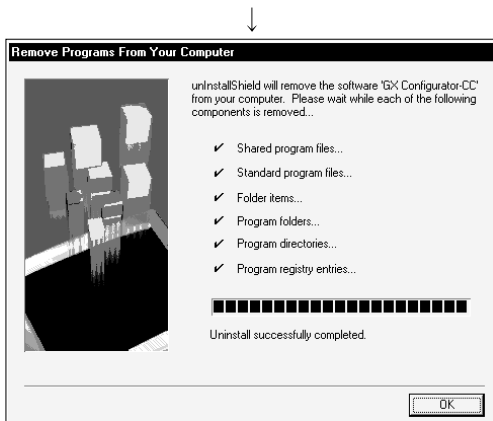

6. Click when the message indicating the end of removal has appeared.

When the message indicating completion has appeared, uninstallation is complete.

3.3 Starting and Ending GX Configurator-CC

This section provides how to start and end GX Configurator-CC.

(1) Starting method

Choose the [Start]—[Programs *]—[MELSEC Application]—[GX Configurator-CC] menu.

※: [All programs] is displayed when Windows® XP Professional or Windows® XP Home Edition is used.



Choose the connected CPU and click the "OK" button.

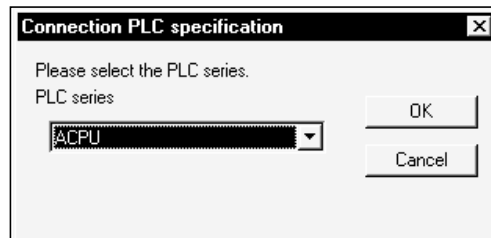

(2) Ending method

Choose [File]—[Exit] on GX Configurator-CC.

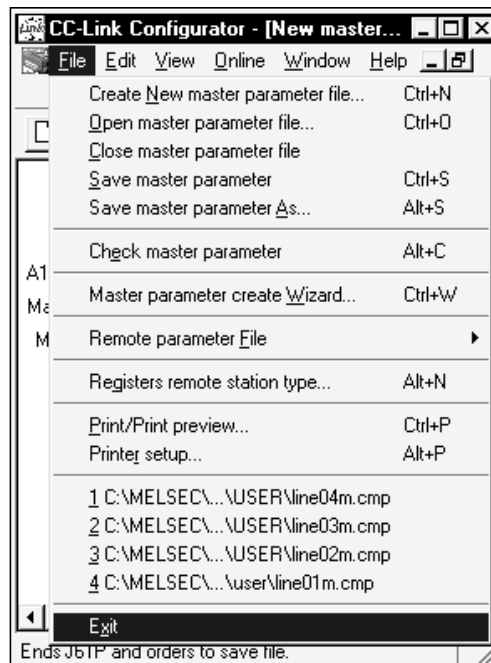

3.4 Installing the USB Driver

When Windows® 2000 Professional, Windows® XP Professional and Windows® XP Home Edition is used, the USB driver must be installed to make CPU USB communication.

The following is the USB driver installation procedure.

POINT
<p>If the USB driver cannot be installed, check the following setting.</p> <ul style="list-style-type: none"> • When Windows® 2000 Professional is used <p>If you have selected "Block-Prevent installation of unsigned files" after [Control Panel] - [System] - [Hardware] - [Driver Signing], the USB driver may not be installed.</p> <p>Choose "Ignore-Install all files, regardless of file signature" or "Warn-Display a message before installing an unsigned file" for [Driver Signing], and install the USB driver.</p> • When Windows® XP Professional or Windows® XP Home Edition is used <p>If you have selected "Block-Never install unsigned driver software" after [Control Panel] - [System] - [Hardware] - [Driver Signing], the USB driver may not be installed.</p> <p>Choose "Ignore-Install the software anyway and don't ask for my approval" or "Warn-Prompt me each time to choose an action" for [Driver Signing], and install the USB driver.</p>

[1] When Windows® 2000 Professional is used

The following indicates the procedure for installing the USB driver when using Windows® 2000 Professional.



1) The screen shown on the left appears when you connect the personal computer and QCPU (Q mode) by the USB cable.

Click the Next >.



(To the next page)

(From the previous page)



2) Choose " Search for a suitable driver for my device (recommended)" and click the **Next>**.

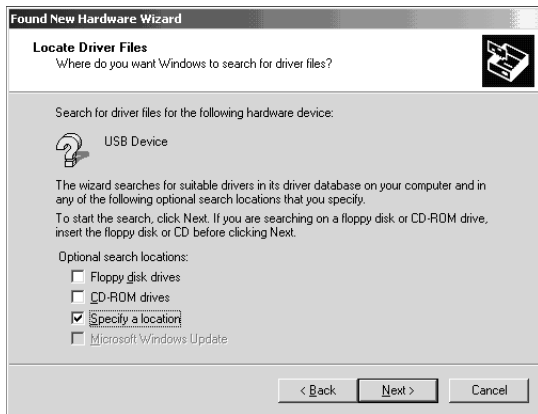

3) Check "Specify a location" and click the **Next>**.



4) As the screen on the left appears, set the GX Configurator-CC installation destination "Easysocket\USBdrivers" and click the **Next>**.

The screen shown on the left shows the example of setting C:\MELSEC\Easysocket\USBdrivers. If volume MELSOFT products have been installed, browse the installation destination of the first product.



5) The screen on the left appears to indicate completion of installation. Click the **Finish** to terminate installation.

(Completion)

[2] When Windows® XP Professional and Windows® XP Home Edition is used

The following indicates the procedure for installing the USB driver when using Windows® XP Professional or Windows® XP Home Edition.



- 1) The screen shown on the left appears when you connect the personal computer and QCPU (Q mode) by the USB cable. Choose "Install from a list or specific location [Advanced]" and click the **Next>**.

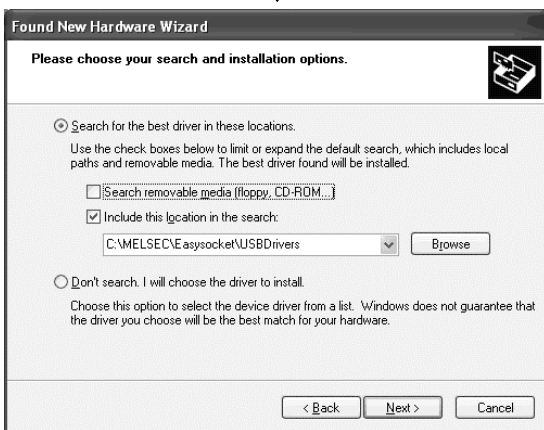

- 2) As the screen on the left appears, choose "Include this location in the search". Check "Include this location in the search" and set "Easysocket\USBDrivers" of the folder where GX Configurator-CC was installed. After setting, click the **Next>**. The screen shown on the left shows the example of setting C: \MELSEC\Easysocket\USBDrivers. If volume MELSOFT products have been installed, browse the installation destination of the first product.



- 3) As the screen on the left appears, click the **Continue Anyway**.

REMARKS

Though the screen on the left appears during installation of the USB driver, we have confirmed that the USB driver operates properly using Windows® XP Professional or Windows® XP Home Edition. (No problem will occur after installation of the USB driver.) Click **Continue Anyway** to continue the installation of the USB driver.

(To the next page)

(From the previous page)



4) The screen on the left appears to indicate completion of installation. Click the **Finish** to terminate installation.



(Completion)

4 OPERATION PROCEDURES

The GX Configurator-CC operating procedures are given below.

(1) Creating a master parameter file and writing it to the master station (AJ61BT11, A1SJ61BT11 only)

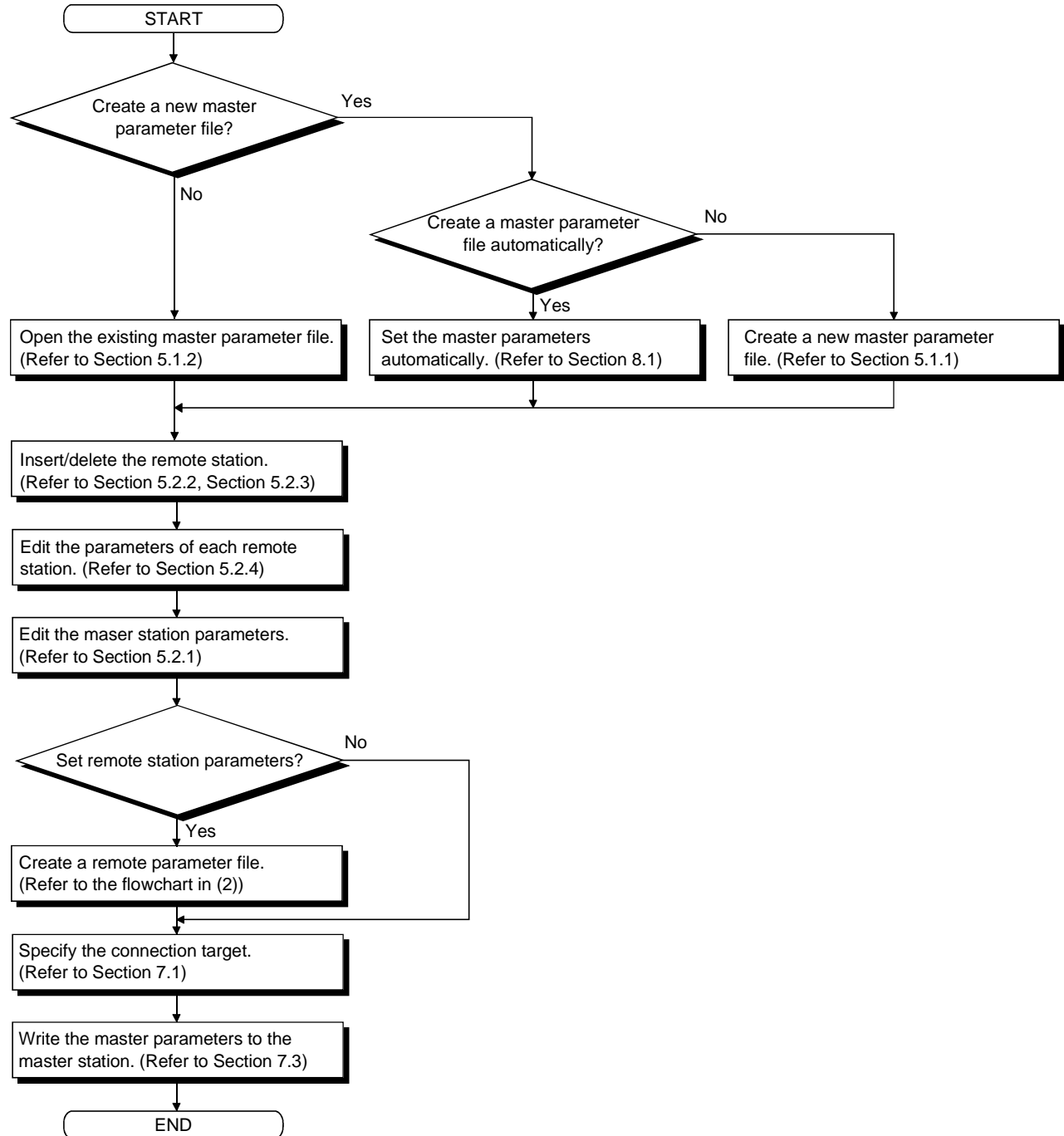

4

(2) Creating a remote parameter file and writing it to the master station
 Refer to Section 6.1 for remote parameter operation.

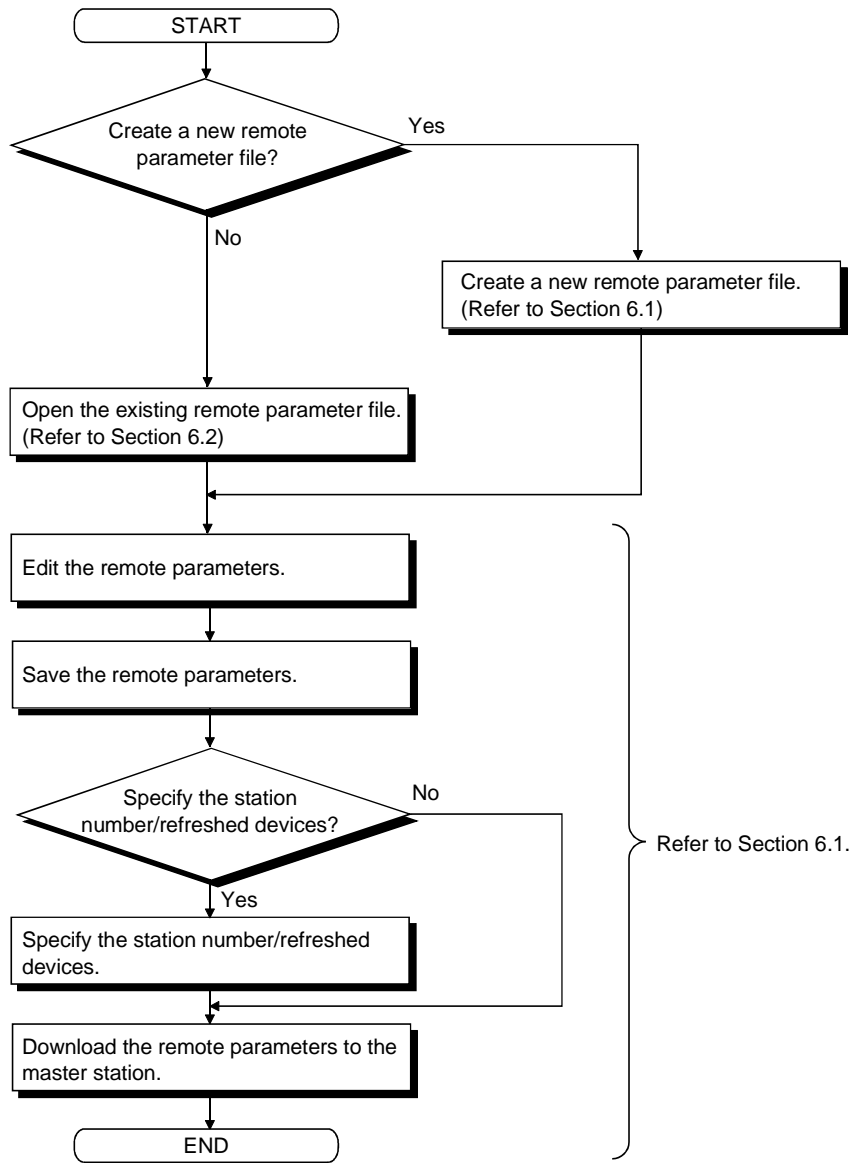

4

(3) Setting and monitoring the R2 buffer memory (AJ61BT11, A1SJ61BT11 only)

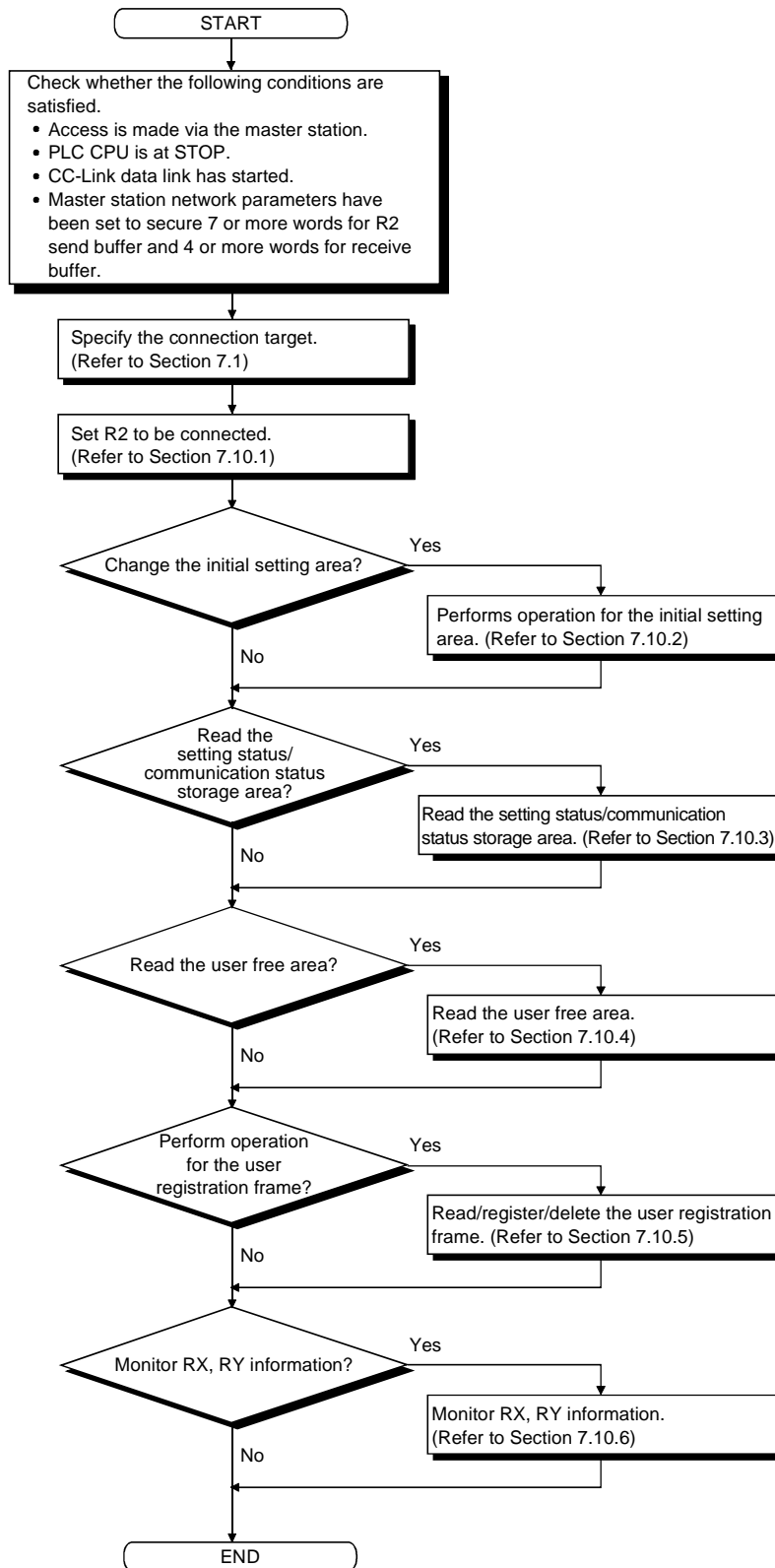

5 SETTING THE MASTER PARAMETERS (AJ61BT11, A1SJ61BT11 ONLY)

This chapter explains how to set the master parameters.

POINT

For details of the data set with the master parameters, refer to the CC-Link System Master/Local Module User's Manual (Details).

5.1 File Operations

5.1.1 Creating a new master parameter file

- (1) Purpose of operation
Create a new master parameter file.
- (2) Operation procedure
Perform any of the following operations.
 - Choose the [File]—[Create New master parameter file...] menu.
 - Click .
 - Press the "Ctrl" + "N" keys.
- (3) Setting screen

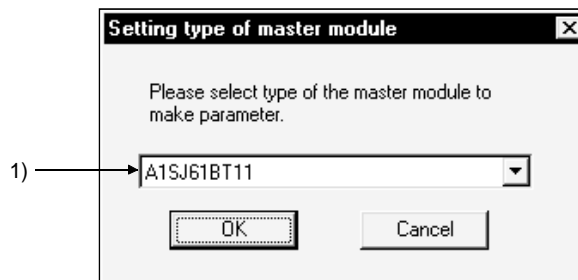

Item	Description
1) Master module type	Choose the type of the master module used. Incorrect setting will result in an error when the master parameters are written to the master station.
"OK" button	Used to determine the setting and create a new master parameter file.
"Cancel" button	Used to suspend master parameter file creation.

5.1.2 Opening the existing master parameter file

- (1) Purpose of operation
Open the existing master parameter file.
- (2) Operation procedure
Perform any of the following operations.
 - Choose the [File]—[Open master parameter file...] menu.
 - Click .
 - Press the "Ctrl" + "O" keys.
- (3) Setting screen

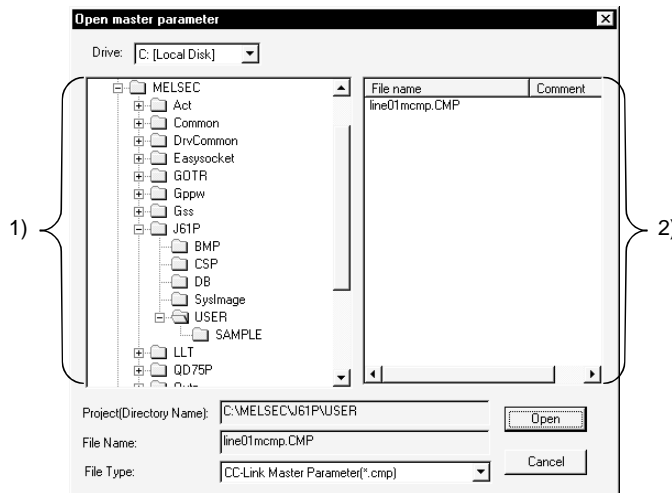

Item	Description
Drive	Choose the drive name where the master parameters are stored.
1) Folder list	Choose the folder name where the master parameters are stored.
2) File list	Choose the master parameter file you want to open.
Project (Directory Name)	Shows the project (directory name) currently selected.
File Name	Shows the file name currently selected.
File Type	Shows the file type that can be opened. You can choose either of the master parameter (*.cmp) and CCMAP data (*.ccm).
"Open" button	Used to open the specified master parameter file.
"Cancel" button	Used to close this screen without opening the master parameter file.

REMARK

CCMAP is the SW1D5N-CCMAP CC-Link parameter setting support software package (free software) which can be downloaded on MELFANSWeb. To get the download service, you need to register as a MELFANSWeb member.

5.1.3 Closing the master parameter file being edited

- (1) Purpose of operation
Close the master parameter file being edited.
- (2) Operation procedure
Choose [File]—[Close master parameter file...].
- (3) Explanation
An inquiry screen appears if the master parameter file name is not set or the master parameters have been edited.
Click the "Yes" button to save the master parameter changes.
Click the "No" button to exit without saving the master parameters.
Click the "Cancel" button to suspend the closing operation and return to the screen.

5.1.4 Saving the master parameters being edited

- (1) Purpose of operation
Save the master parameters being edited.
- (2) Operation procedure
 - (a) When saving
Perform any of the following operations.
 - Choose [File]—[Save master parameter] menu.
 - Click .
 - Press the "Ctrl" + "S" keys.
 - (b) When saving with a name
Perform either of the following operations.
 - Choose [File]—[Save master parameter As...] menu.
 - Press the "Alt" + "S" keys.
- (3) Setting screen

The following screen appears when a file name is not set to the master parameter file or when the master parameter file will be saved with a name.

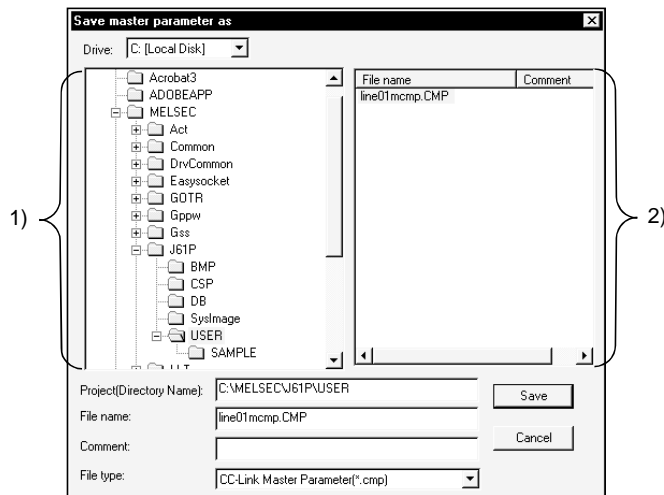

Item	Description
Drive	Choose the drive name where the master parameters will be stored.
1) Folder list	Choose the folder name where the master parameters will be stored.
2) File list	Choose the master parameter file which is stored in the save destination folder.
Project (Directory Name)	Shows the project (directory name) currently selected.
File name	Set the file name of the master parameter file to be saved.
Comment	Set the comment for the master parameter file to be saved.
File type	Shows the file type that may be saved.
"Save" button	Used to save the master parameter file with the specified file name.
"Cancel" button	Used to close this screen without saving the master parameters.

POINT

There are the following restrictions on the project (directory name) and file name that may be set.

- Number of characters

The numbers of characters in a project (directory name) and a file name (8 or more characters may be set including an extension) are within 64, respectively.

- Unusable characters

/, \, >, <, *, ?, ", |, :, ; (: and \ may be set to only specify the drive.)

Do not use . (period) at the end of a file name.

5.2 Editing the Master Parameters

5.2.1 Setting the detailed information of the master parameters

- (1) Purpose of operation
Set the detailed parameters of the master station such as the number of modules connected, number of retries, and number of automatic return stations.
- (2) Operation procedure
Perform any of the following operations.
 - Choose the [Edit]—[Master parameter details...] menu.
 - Double-click the on-screen picture of the master station or press the "Enter" key.
 - Right-click the on-screen picture of the master station and choose the [Master parameter details] menu.
 - Press the "Ctrl" + "M" keys.
- (3) Setting screen

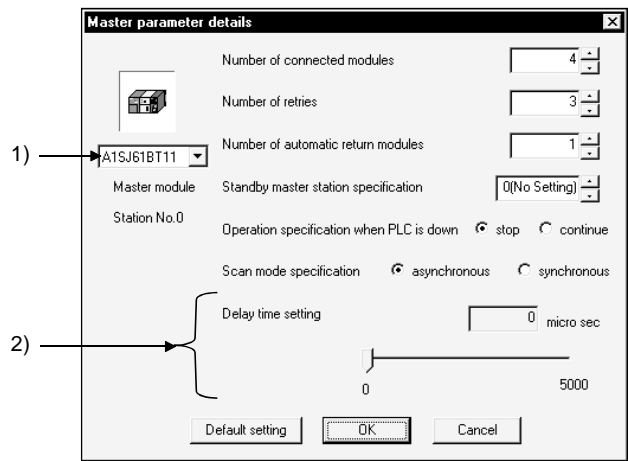

Item	Description
1) Master module type	You can change the type of the master module used.
Number of connected modules	Set the total number of modules connected, including the reserved and error invalid stations. Increasing the connected modules adds the default remote I/O stations. Decreasing the connected modules deletes the remote stations, beginning with the ones having the greater station numbers.
Number of retries	Set the number of retries to be made at communication error.
Number of automatic return modules	Set the number of stations that can return to the network automatically during one scan.
Standby master station specification	Set the station number of the standby master station. The station that may be specified as the standby master station is only a local station. In addition, a sequence program is required separately for use as the standby master station. For more information, refer to the CC-Link system master/local module user's manual (details).

5 SETTING THE MASTER PARAMETERS (AJ61BT11, A1SJ61BT11 ONLY) MELSOFT

Item	Description
Operation specification when PLC is down	Set whether data link is to be continued or stopped at occurrence of a PLC CPU stop error.
Scan mode specification	Set whether link scans are synchronous or asynchronous with sequence scans. "synchronous" may be used only when the CC-Link-dedicated instruction (RLPA instruction) is used. Therefore, set "asynchronous" on GX Configurator-CC.
2) Delay time setting	Set the link scan interval. The link scan interval indicates a time interval between the end of a link scan and the start of the next link scan.
"Default setting" button	Used to return the settings to the initial values.
"OK" button	Used to make the settings valid and close this screen.
"Cancel" button	Used to make the settings invalid and close this screen.

5.2.2 Inserting a remote station

- (1) Purpose of operation
Insert a remote station to the master parameter.
- (2) Operation procedure
 - (a) Choose the remote station field where you want to make an insertion.
A remote station is inserted in a place above the selected position.

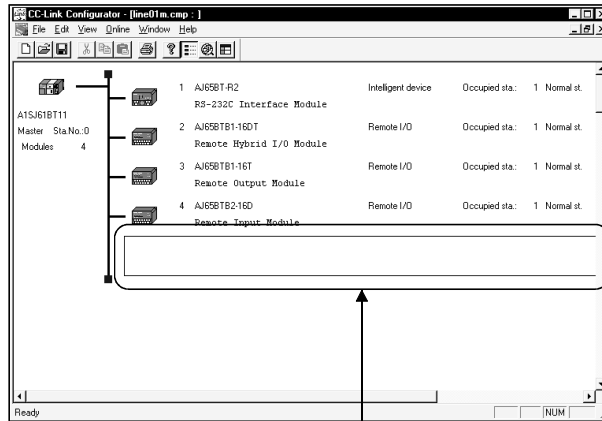

Choose the position of insertion.

- (b) Perform any of the following operations.
 - Choose the [Edit]—[Insert remote station] menu.
 - Right-click the selected remote station field and choose the [Insert remote station] menu.
 - Press the "Ctrl" + "I" keys or press the "Insert" key.
- (3) Setting screen

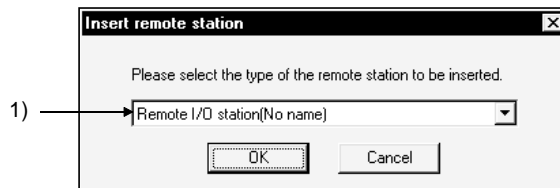

Item	Description
1) Remote station type	Choose the type of the remote station to be inserted.
"OK" button	Used to make the setting valid and close this screen.
"Cancel" button	Used to make the setting invalid and close this screen.

- (4) Using the remote station list to insert a remote station
- (a) Perform any of the following operations to show the remote station list.
- Choose the [View]—[Remote station lists...] menu.
 - Click .
 - Press the "Alt" + "L" keys.
- (b) Choose the remote station to be inserted and drag it onto the master parameter screen.

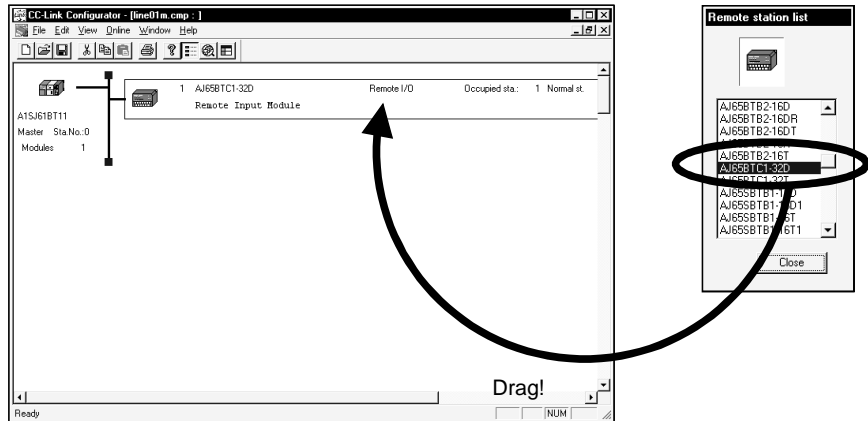

5.2.3 Deleting the remote station

- (1) Purpose of operation
Delete the remote station which was set to the master parameter.
- (2) Operation procedure
 - (a) Choose the field of the remote station you want to delete.

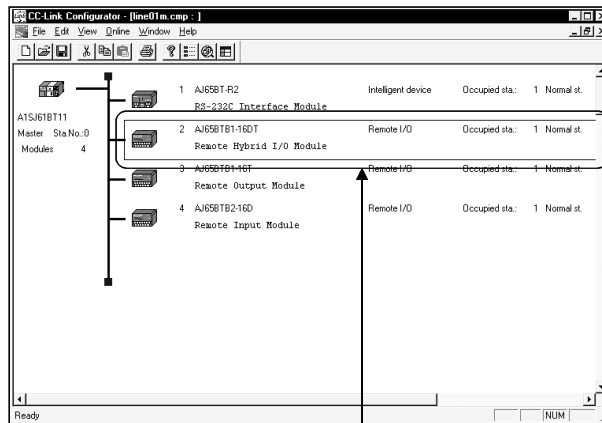

Choose the position of deletion.

- (b) Perform any of the following operations.
 - Choose the [E]dit—[D]elete remote station] menu.
 - Right-click the selected remote station field and choose the [Delete remote station] menu.
 - Press the "Ctrl" + "D" keys or press the "Delete" key.

POINTS
<ul style="list-style-type: none"> • You cannot restore the remote station once deleted. • You cannot delete the remote station specified as the standby master station. Make a deletion after canceling the designation of the standby master station. • When you do not want to change the system configuration, set the station to be deleted as a reserved station.

5.2.4 Setting remote station information

- (1) Purpose of operation
Set the information on the remote station which was set to the master parameter.
- (2) Operation procedure
 - (a) Choose the field of the remote station to which you want to set information.

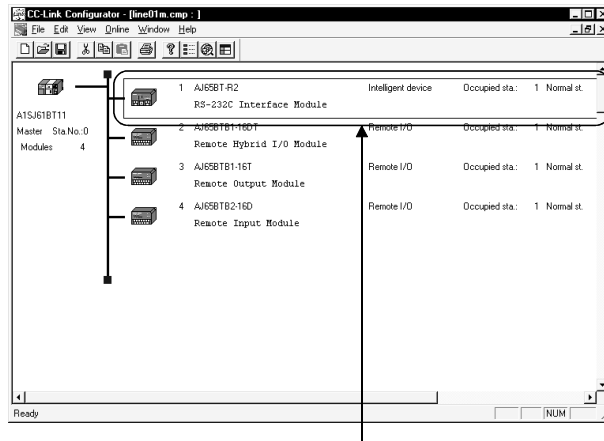

Choose the remote station whose information will be set.

- (b) Perform any of the following operations.
 - Choose the [Edit]—[Edit remote station...] menu.
 - Double-click the selected remote station field.
 - Right-click the selected remote station field and choose the [Edit remote station...] menu.
 - Press the "Ctrl" + "R" keys or press the "Enter" key.
- (3) Setting screen

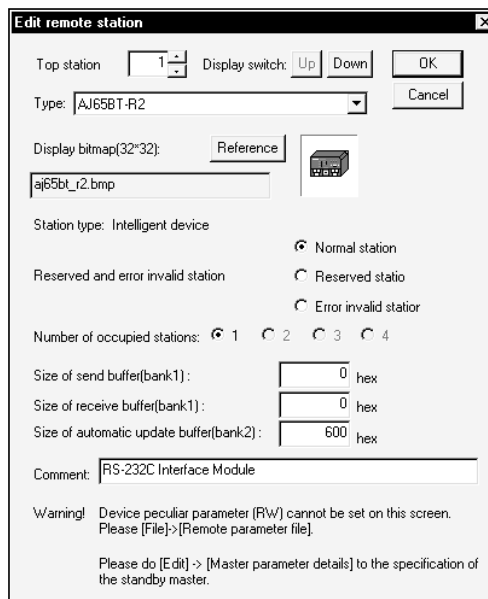

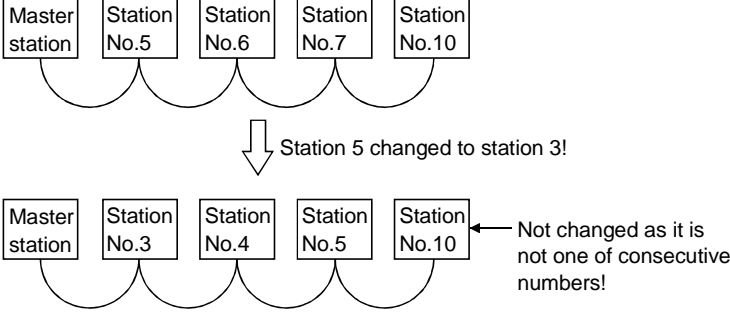
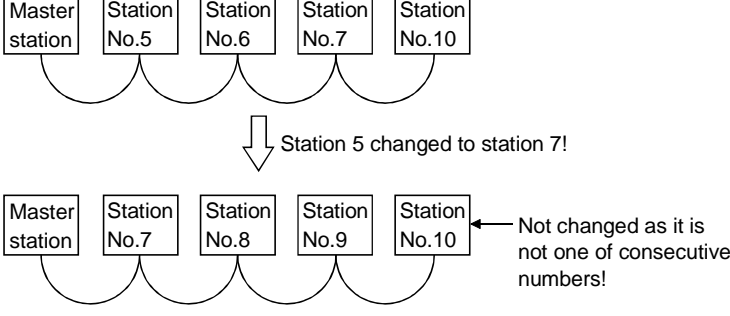
Item	Description
Top station	<p>Set the station number.</p> <p>If you decreased the station number which is followed by consecutive station numbers, the station numbers of the subsequent stations are also updated to make them consecutive.</p>  <p>If you increased the station number to the same number of one of the subsequent station numbers, the station numbers of the subsequent stations are changed to larger numbers.</p> 
Display switch	<p>Used to change the remote station to be edited.</p> <p>Click the "↑" button to switch to the remote station of the preceding station number.</p> <p>Click the "↓" button to switch to the remote station of the subsequent station number.</p>
Type	Set the type of the remote station.
Display bitmap	<p>Shows the file name of the on-screen module picture.</p> <p>Click the "Browse" button and change the file name to change the module picture displayed.</p>
Station type	Shows the station type.
Reserved and error invalid station	Set the reserved/error invalid station.
Number of occupied stations	Set the number of stations occupied.
Size of send buffer	Set the buffer memory sizes for transient transmission. (Only for intelligent device station editing)
Size of receive buffer	
Size of automatic update buffer	
Comment	Set a comment.
"OK" button	Used to determine the settings and close this screen.
"Cancel" button	Used to discard the settings and close this screen.

5.2.5 Cutting/copying/pasting the remote station

- (1) Purpose of operation
Cut/copy/paste the remote station which was set to the master parameter.
- (2) Operation procedure
 - (a) Choose the field of the remote station you want to cut, copy or paste.

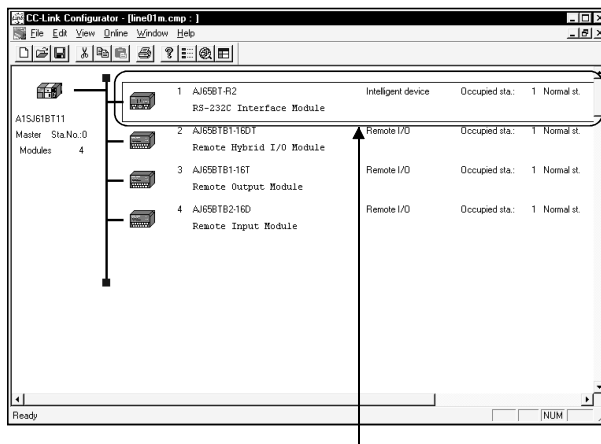

Choose the field of the remote station to be cut, copied or pasted.

- (b) Perform any of the following operations.

1) Cut

- Choose the [Edit]—[Cut] menu.
- Right-click the selected remote station field and choose the [Cut] menu.
- Click .
- Press the "Ctrl" + "X" keys.

2) Copy

- Choose the [Edit]—[Copy] menu.
- Right-click the selected remote station field and choose the [Copy] menu.
- Click .
- Press the "Ctrl" + "C" keys.
- Hold down the "Ctrl" key and drag & drop.

3) Paste

- Choose the [Edit]—[Paste] menu.
- Right-click the selected remote station field and choose the [Paste] menu.
- Click .
- Press the "Ctrl" + "V" keys.

POINTS

- (1) The remote stations after the cut station are shifted up.
- (2) You cannot cut or copy the station which is specified as the standby master station.

5.3 Checking the Set Master Parameters

(1) Purpose of operation

Check whether the master parameters have been set properly.

(2) Operation procedure

Perform any of the following operations.

- Choose the [File]—[Check master parameters].
- Click .
- Press the "Alt" + "C" keys.

(3) Explanation

If a master parameter error occurs, the screen shows the location of the error that was detected first. Correct the error location.

6 SETTING THE REMOTE PARAMETERS

This chapter explains how to set the remote parameters.

6.1 Creating a New Remote Parameter File

(1) Purpose of operation

Create as a parameter file the values written to RWw of a remote station.

POINT
The remote parameters can be used for setting the parameters of remote stations having E ² PROM, e.g. inverters and AC servos. For remote stations which do not have E ² PROM, e.g. AJ65BT-64AD and AJ65BT-D62, they may be used for read/write testing of RWw.

(2) Operation procedure

Perform either of the following operations.

- Choose the [File]—[Remote parameter File]-[New].
- Press the "Alt" + "D" keys.

(3) Setting screen 1

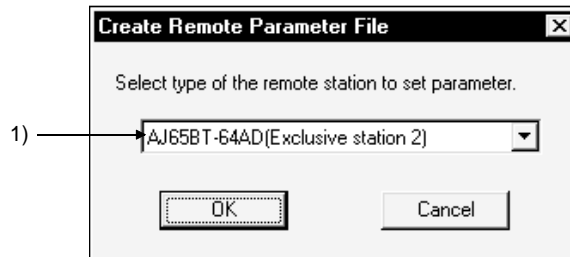

Item	Description
1) Remote station type	Choose the type of the remote station for which a new remote parameter file will be created.
"OK" button	Used to open the "setting screen 2". Refer to (4).
"Cancel" button	Used to make the setting invalid and close this screen.

(4) Setting screen 2

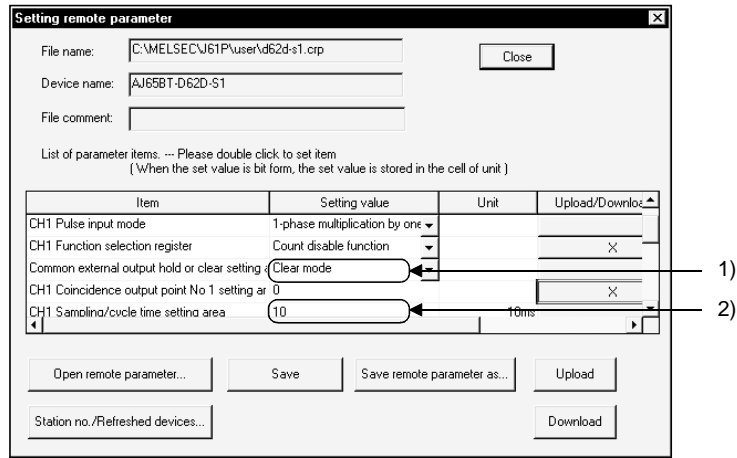

Item	Description
File name	Shows the name of the open remote parameter file.
Device name	Shows the remote station name to which the remote parameters have been set.
File comment	Shows the comment of the remote parameter file.
"Close" button	Used to close this screen.
Item	Shows the RWw data of the remote station.
Setting value	Shows the value set to each item. When upload was performed, the values read from the remote station appear.
1) When list box is displayed	When there is a list box, choose and set any value.
2) When value is displayed	When a value is displayed, double-clicking shows the following screen. <div style="text-align: center;"> </div> <p>Set a value.</p> <p>Choose whether the value is specified in decimal or hexadecimal.</p> <p>Used to close this screen and reflect the value set in the Setting value field.</p> <p>Used to make the setting invalid and close this screen.</p>

Item	Description												
<p>Setting value</p> <p>When "Bit data setting" button is displayed</p>	<p>Set the bit data for RWw.</p> <table border="1" data-bbox="491 398 1406 499"> <thead> <tr> <th>Item</th> <th>Setting value</th> <th>Unit</th> <th>Upload/Download</th> </tr> </thead> <tbody> <tr> <td>Average processing specification</td> <td>Bit data setting...</td> <td>0</td> <td></td> </tr> <tr> <td>CH1 average time/average number of times</td> <td>0</td> <td></td> <td></td> </tr> </tbody> </table> <p>Clicking shows the following screen.</p> <p>Shows the item names to be set.</p> <p>Choose the value from the list box. When upload was performed, the read values appear.</p> <div data-bbox="647 667 1145 896"> </div> <p>Used to make the settings valid and close this screen.</p> <p>Used to make the settings invalid and close this screen.</p>	Item	Setting value	Unit	Upload/Download	Average processing specification	Bit data setting...	0		CH1 average time/average number of times	0		
Item	Setting value	Unit	Upload/Download										
Average processing specification	Bit data setting...	0											
CH1 average time/average number of times	0												
<p>Unit</p>	<p>Shows the units of the setting values.</p> <p>When the bit data was set in "Bit data setting", the set data is displayed in hexadecimal.</p>												
<p>Upload/Download set</p> <p>When check box is displayed</p> <p>When "Detail setting" button is displayed</p>	<p>Checking the check box makes upload or download of the corresponding item valid. If it is not checked, upload or download of the corresponding item cannot be performed.</p> <p>Clicking opens the detail screen of the item set to the setting value. Refer to the "Detail setting" screen in (a).</p> <table border="1" data-bbox="491 1272 1406 1384"> <thead> <tr> <th>Item</th> <th>Setting value</th> <th>Unit</th> <th>Upload/Download</th> </tr> </thead> <tbody> <tr> <td>Instruction code</td> <td>Parameter read</td> <td></td> <td>Detail setting...</td> </tr> </tbody> </table>	Item	Setting value	Unit	Upload/Download	Instruction code	Parameter read		Detail setting...				
Item	Setting value	Unit	Upload/Download										
Instruction code	Parameter read		Detail setting...										
<p>"Open remote parameter" button</p>	<p>As the screen appears, choose the remote parameter file you want to open. Refer to Section 6.2 for screen operation.</p>												
<p>"Save" button</p>	<p>Used to save the remote parameter file. If the file name is not set, the screen appears. Set the file name and save the file.</p>												
<p>"Save remote parameter as" button</p>	<p>As the screen appears, specify the save destination folder and file names and save the remote parameter file. For screen operation, refer to "Save remote parameter as" screen in (b).</p>												
<p>"Station no./Refreshed devices" button</p>	<p>As the screen appears, set the station number and the refreshed devices corresponding to the station number when refresh is made. If they are not set correctly, upload or download cannot be performed properly. For screen operation, refer to the "Station no./Refreshed devices" screen in (c).</p>												

Item	Description
"Upload" button	Used to read from the remote station the data of the items checked in "Upload/Download". Before starting upload, make sure that the "Station no./Refreshed devices" are set correctly. If they are not set correctly, upload cannot be performed properly.
"Download" button	Used to write to the remote station the data of the items checked in "Upload/Download". Before starting download, make sure that the "Station no./Refreshed devices" are set correctly. If they are not set correctly, download cannot be performed properly.

(a) "Detail setting" screen

Used to make detail setting of RWw of an inverter or AC servo.

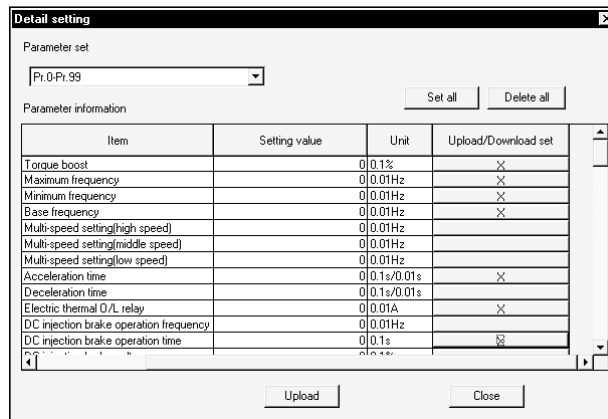

Item	Description
Parameter set	In the list box, choose the data to be displayed in Parameter information.
"Set all" button	Used to check all check boxes in Upload/Download set.
"Delete all" button	Used to uncheck all check boxes in Upload/Download set.
Item	Shows the data of RWw of the remote station.
Setting value	<p>Double-clicking shows the following screen.</p> <p>Set a value.</p> <p>Choose whether the value is specified in decimal or hexadecimal.</p> <p>Used to close this screen and reflect the value set in the Setting value field.</p> <p>Used to make the setting invalid and close this screen.</p>
Unit	Shows the units of the setting values.
Upload/Download set	Checking the check box makes upload or download of the corresponding item valid. If it is not checked, upload or download of the corresponding item cannot be performed.
"Upload" button	Used to read the data of the items checked in "Upload/Download set" from the remote station. Before starting upload, make sure that the "Station no./Refreshed devices" are set correctly. If they are not set correctly, upload cannot be performed properly.

Item	Description
"Download" button	<p>Used to write the data of the items checked in "Upload/Download set" to the remote station. Before starting download, make sure that the "Station no./Refreshed devices" are set correctly.</p> <p>If they are not set correctly, download cannot be performed properly.</p> <div data-bbox="700 472 1195 584" style="text-align: center;"></div>
"Close" button	Used to close this screen.

POINT

The "Upload" button appears only when the setting value in (4) Setting screen 2 is "Read instruction code", "Parameter read".

The "Download" button appears only when the setting value in (4) Setting screen 2 is "Write instruction code", "Parameter write".

(b) "Save remote parameter as..." screen

Used to set the remote parameter save destination and save the remote parameter file.

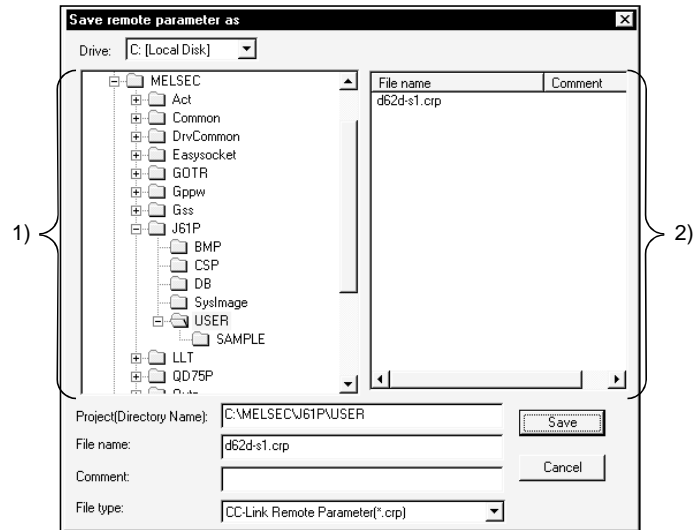

Item	Description
Drive	Choose the drive name where the remote parameters will be stored.
1) Folder list	Choose the folder name where the remote parameters will be stored.
2) File list	Specify the remote parameter file which is stored in the save destination folder.
Project (Directory Name)	Set the project (directory name) currently selected. If the project specified does not exist, a new project is created.
File name	Set the file name of the remote parameter file to be saved.
Comment	Set the comment for the remote parameter file to be saved.
File type	Shows the file type that may be saved.
"Save" button	Used to save the remote parameter file with the specified file name.
"Cancel" button	Used to close this screen without saving the remote parameters.

POINT
<p>There are the following restrictions on the project (directory name) and file name that may be set.</p> <ul style="list-style-type: none"> • Number of characters The numbers of characters in a project (directory name) and a file name (8 or more characters may be set including an extension) are within 64, respectively. • Unusable characters /, \, >, <, *, ?, ", , :, ; (: and \ may be set to only specify the drive.) Do not use . (period) at the end of a file name.

(c) "Station no./Refreshed devices..." screen

Used to make setting to access the refreshed devices.

As the following screen appears, set the station number and the refreshed devices corresponding to the station number when the FROM/TO instruction or CC-Link-dedicated instruction (RRPA instruction) is used to refresh RX, RY, RWw and RWr.

If they are not set correctly, upload or download cannot be performed properly.

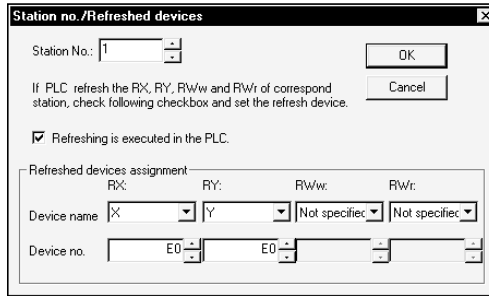

Item	Description
Station No.	Set the station number whose refreshed devices will be specified.
Refreshed devices assignment	Specify the refreshed devices for the specified station number.
Device name	Set the refreshed device names. Set "Not specified" for the devices not refreshed.
Device no.	Set the device numbers of the refreshed device names. Set the first device number for the specified station number.
"OK" button	Used to determine the settings and close this screen.
"Cancel" button	Used to discard the settings and close this screen.

POINT

When the FROM/TO instruction is used and the PLC CPU is at STOP, refresh is not made and the settings on this screen are not necessary.

6.2 Opening the Existing Remote Parameter File

- (1) Purpose of operation
Open the existing remote parameter file.
- (2) Operation procedure
Perform either of the following operations.
 - Choose the [Remote parameter File]—[Open] menu.
 - Press the "Ctrl" + "E" keys.
- (3) Setting screen

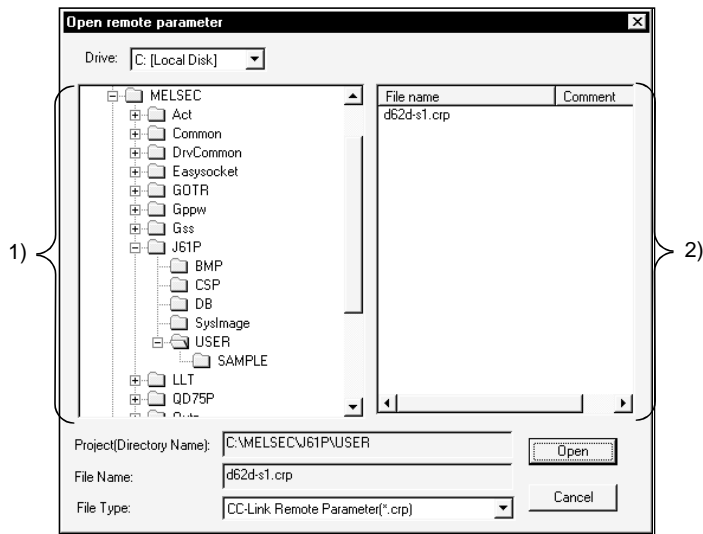

Item	Description
Drive	Choose the drive name where the remote parameters are stored.
1) Folder list	Choose the folder name where the remote parameters are stored.
2) File list	Choose the remote parameter file you want to open.
Project (Directory Name)	Shows the project (directory name) currently selected.
File Name	Shows the file name currently selected.
File Type	Shows the file type that can be opened.
"Open" button	Used to open the specified remote parameter file.
"Cancel" button	Used to close this screen without opening the remote parameter file.

7 ONLINE OPERATIONS

This chapter describes the online operations to be performed on the personal computer connected to the PLC CPU.

 WARNING	<ul style="list-style-type: none"> ● When performing data changes or status control from the peripheral device to the running PLC, configure up an interlock circuit outside the PLC system to ensure that the whole system will operate safely. <p>In addition, predetermine corrective actions for the system so that you can take measures against any communication error caused by a cable connection fault or the like in online operations performed from the peripheral device to the running PLC.</p>
--	---

7.1 Specifying the Connection Target

- (1) Purpose of operation
Set the personal computer's COM port, transmission speed, connection method to the PLC CPU, and others.
- (2) Operation procedure
Perform any of the following operations.
 - Choose the [Online]—[Transfer setup...] menu.
 - Press the "Alt" + "T" keys.
- (3) Setting screen 1

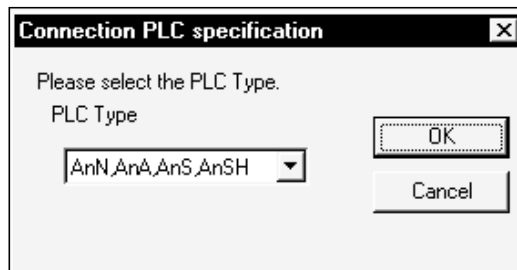

Item	Description
PLC Type	Set the PLC Type connected to the personal computer. Refer to the following table.
"OK" button	Used to determine the setting and open the "setting screen 2". Refer to (4).
"Cancel" button	Used to stop the transfer setup.

Selected PLC Series	Displayed PLC Type	CPU Type
A series	AnN, AnA, AnS, AnSH	A0J2H, A1FX, A1S, A1SJ, A1SH, A1SJH, A1N, A2C, A2CJ, A2N(S1), A2S, A2SH, A3N, A2A(S1), A3A
	AnU, A2AS	A2U(S1), A2AS(S1), A2USH-S1, A3U, A4U
QnA series	Not displayed	Q2A, Q2AS(H), Q2AS1, Q2AS(H)S1, Q3A, Q4A, Q4AR
Q series (Q mode)	Qn(H)	Q02(H), Q06H, Q12H, Q25H
	Remote I/O	Remote I/O
	Q00, Q01, Q00J	Q00J, Q00, Q01
Q series (A mode)	Not displayed	Q02(H)-A, Q06H-A

(4) Setting screen 2

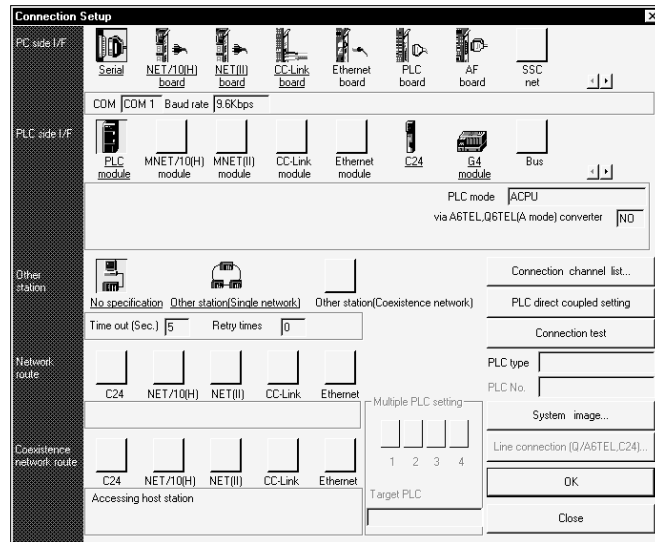

Item	Description
PC side I/F	Specify the interface on the personal computer side where GX Configurator-CC has been installed.
PLC side I/F	Specify the PLC side interface to be connected with GX Configurator-CC.
Other station	Choose whether to specify the host station or other station.
"OK" button	Used to confirm the settings.
"Cancel" button	Used to stop Transfer setup.

Refer to Sections 7.1.1 to 7.1.3 for details of the setting screen 2.

(5) Setting screen 3

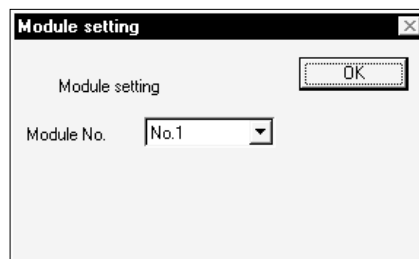

Specify which CC-Link module will be connected.

7.1.1 When accessing the own station

- (1) Purpose of operation
Specify when making access to the own station.
- (2) Operating Procedure
Select [Online] → [Transfer setup].
- (3) Dialog Box

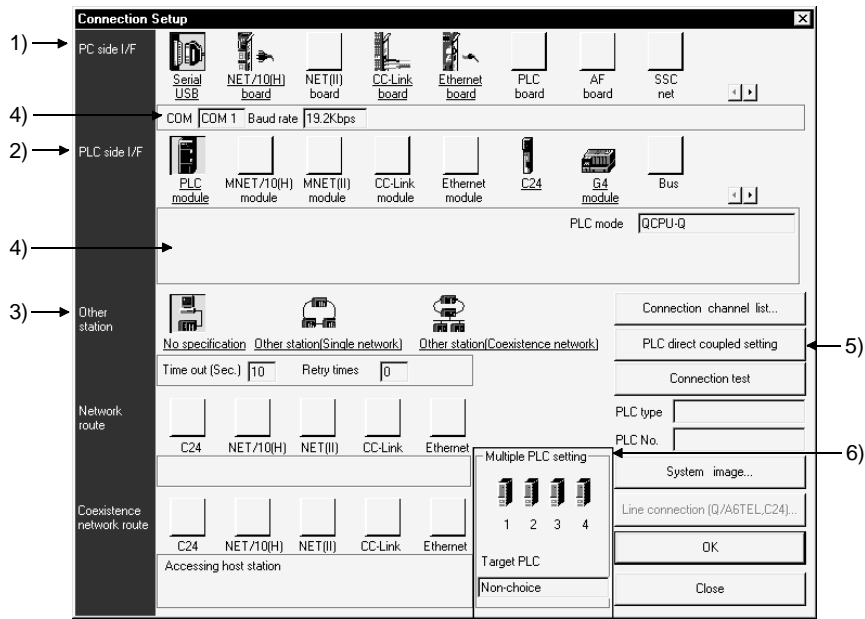

POINT

An underline on the setting screen indicates that detailed setting can be made by double-clicking it.
 The icons displayed can be selected.
 The icon shown yellow means that it has already been selected.

- (4) Description
 - 1) PC side I/F
 - For Q series

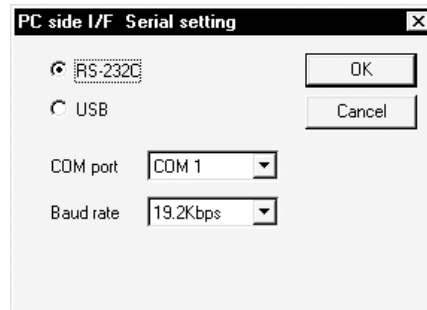

- USB may be set only when the QCPU (Q mode) has been selected.
- Precautions for communication at 115.2/57.6kbps
 - Fast communication cannot be made if the personal computer used is not compatible with the communication speed of 115.2/57.6kbps.
 - If communications delay due to communications tries or a communication error occurs, reduce the baud rate setting and restart communication.
- Refer to (3), (4), (5) in POINT of Section 7.1 for precautions for making USB communication.

QnA/A series

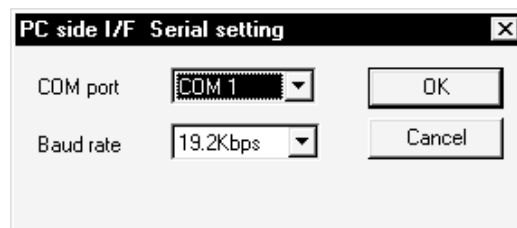

- The baud rate value that may be chosen differs between the PLC series and PLC types.
- Choose for the A series 9.6Kbps.
- For the QnA series, the CPU that can communicate at the communication speed of 38.4kbps is the QnACPU whose function version is B or later.

- 2) PLC side I/F

Choose the PLC series of the PLC to be connected with GX Configurator-CC.

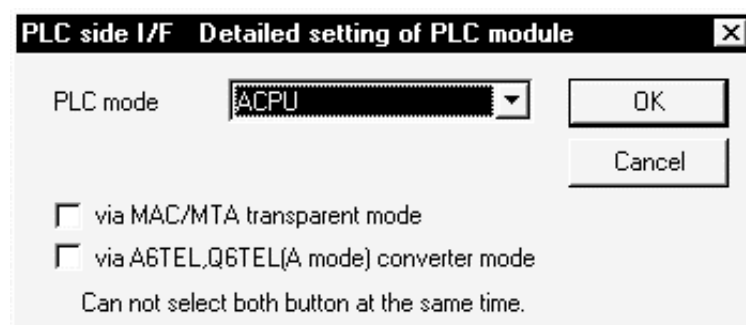

3) Other station

Choose No specification when specifying the own station.

When power-off, hardware reset or the like of the PLC CPU is performed during ladder monitor, it will take time until a communications error appears.

Until the error appears, during execution is displayed in Monitor status.

The longest time until the error appears can be found by the following expression.

$(\text{Time specified for communications time check}) \times 3 \times (\text{Count specified for the number of retries} + 1)$

For example, when the communications time check is specified as 30 seconds and the number of retries as 0 times, the resultant time is $(30 \text{ seconds}) \times 3 \times (0 + 1) = 90 \text{ seconds}$, and the error appears after a maximum of 90 seconds have elapsed.

4) Detailed settings display column

Shows the setting status.

5) PLC direct coupled setting button

This button is useful to change from Other station to the own station.

6) Multiple PLC Setting (setting may be made for only the function version B or later of the QCPU (Q mode))

Refer to Section 7.1.3 (1).

7.1.2 When accessing the other station

- (1) Purpose of operation
Specify when making access to the other station.
- (2) Operating Procedure
Select [Online] → [Transfer Setup].
- (3) Dialog Box
When specifying the other station, it will be convenient to specify the connection target while looking at the connection channel diagram from Connection channel list.

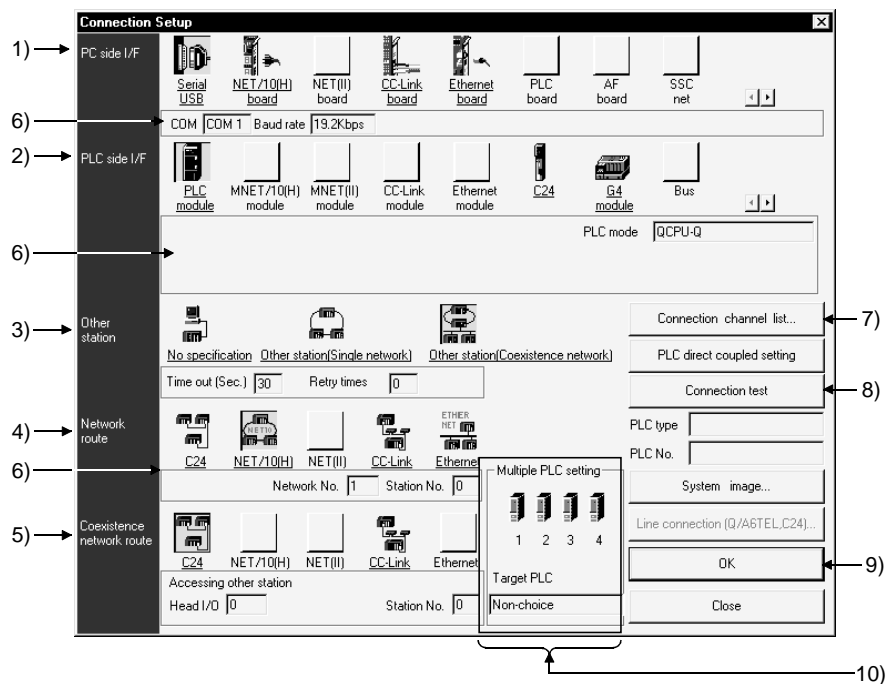

POINT

An underline on the setting screen indicates that detailed setting can be made by double-clicking it.

The icons displayed can be selected.

The icon shown yellow means that it has already been selected.

(4) Description]

1) PC side I/F

Refer to Section 7.1.1

When using GX Configurator-CC on the personal computer CPU module

The following six access paths are supported.

Path	Remarks
Q series bus	Choose  to access the other CPU.
MELSECNET/H MELSECNET/10	<ul style="list-style-type: none"> • Choose the MELSECNET/10(H) board. • Access to the other station requires the PPC-DRV-01 bus interface driver.
CC-Link	<ul style="list-style-type: none"> • Choose the CC-Link board. • Access to the other station requires the PPC-DRV-01 bus interface driver.
Ethernet	Access to the other station can be made by the Ethernet module communication port equipped for the personal computer CPU module as standard.

2) PLC side I/F

Choose the unit to be connected with the personal computer.

3) Other station

What is Single network?

It indicates a system which is configured by a single network and a multilevel system, e.g., only MELSECNET/10 or only Ethernet. (Since Ethernet is regarded as the MELSECNET/10, specify Single network for an MELSECNET/10 and Ethernet mixed system.)

What is Coexistence network?

Set this network when making access to the other station PLC via two different networks.

This network indicates a system which is made up of different networks, e.g. from MELSECNET/10 to CC-Link unit or from Q-compatible C24/QC24 to MELSECNET/10.

This network cannot be chosen for the A series.

4) Network route

When Single network is selected

Choose the network type, network No., station number and first I/O No. to be accessed.

The setting items depend on the network type that has been set.

When Coexistence network is selected

Choose this when making access to the network different from the one where the personal computer is connected.

5) Coexistence network route

Choose the network type, network No., station number and first I/O No. to be accessed.

The setting items depend on the network type that has been set.

6) Detailed settings display column

Shows the setting status.

7) Connection channel list

You can set the connection target while looking at the Connection channel list.

As clicking **OK** automatically sets the connection channel on the Connection Setup screen, settings can be made easily if a complicated system is configured. Set the network number, station number and others as desired according to the access target.

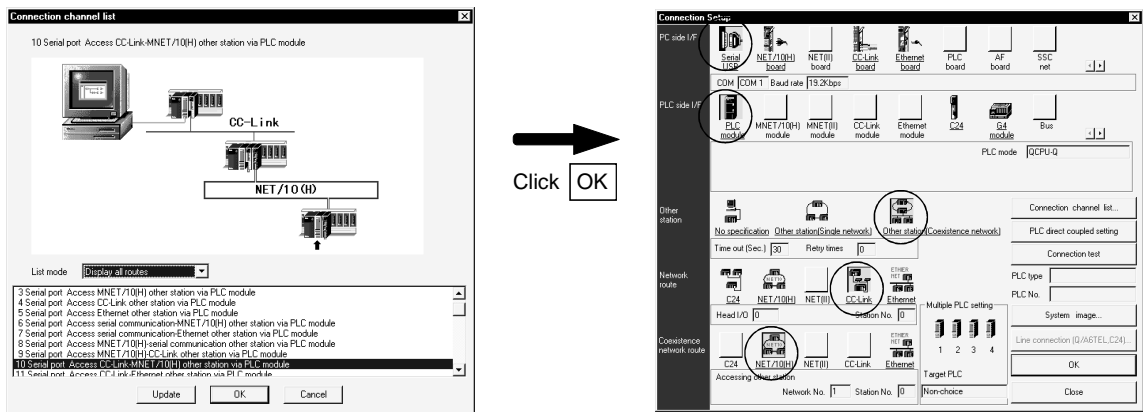

Clicking the **OK** button automatically sets the connection channel (areas enclosed by circles) on the Connection Setup screen.

Changing from one display to another
Convenient usage of Display selected routes

When Display selected routes are selected by specifying the PC side I/F and PLC side I/F on the Connection Setup screen, only the routes in the accessible range are displayed from among the other station, network route and coexistence network route.

A list of system configurations different in series can also be displayed.

Request Source	PC-Connected PLC	Relay Station	Access Target
Personal computer	QCPU (Q mode)	QCPU (Q mode)	Q series
			QnA series
			A series

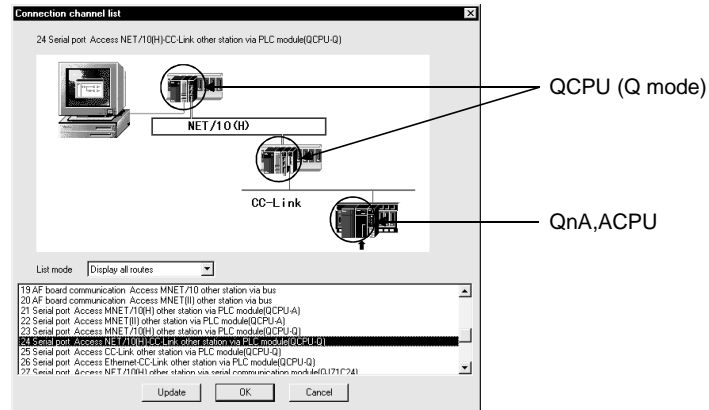

8) Connection test

Tests whether proper access can be made to the PLC set as the access target on the Connection Setup screen.

If proper access can be made, the model name of the PLC as the access target appears in the CPU type field.

9) System image

Illustrates the preset connection channel.

10) Multiple PLC setting

Specify when the access target is multiple CPUs.

For details, refer to Section 7.1.3 (2).

Screen setting for MELSECNET/10 and Ethernet combined system (Single network)
In an MELSECNET/10 and Ethernet mixed system configuration, specify Single network to access the other station. (Since Ethernet is equivalent to the MELSECNET/10)

An example of the Connection Setup setting screen is provided for the following system configuration (Q/QnA only).

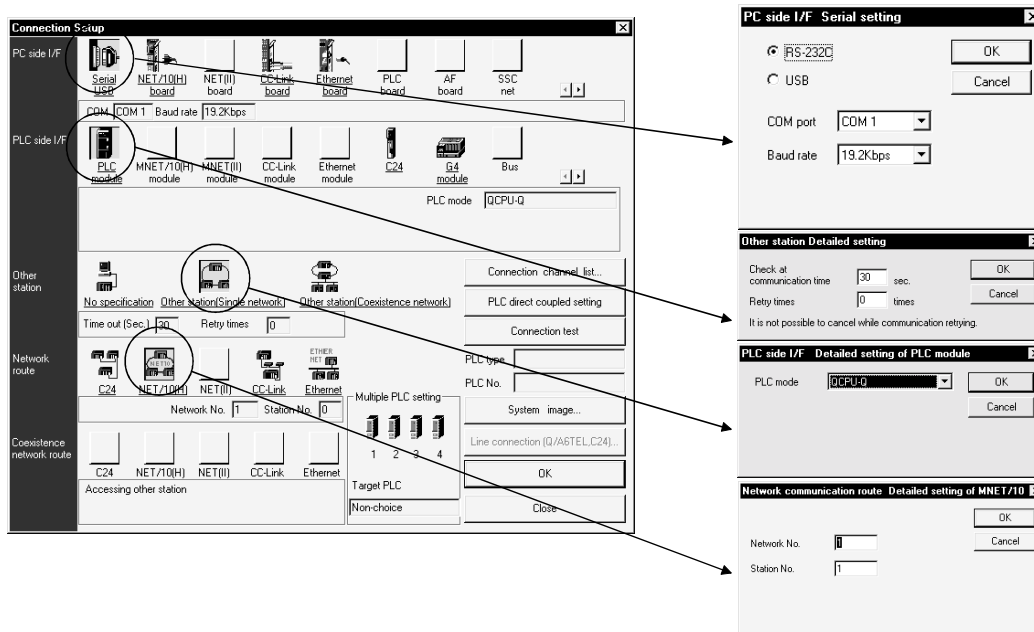
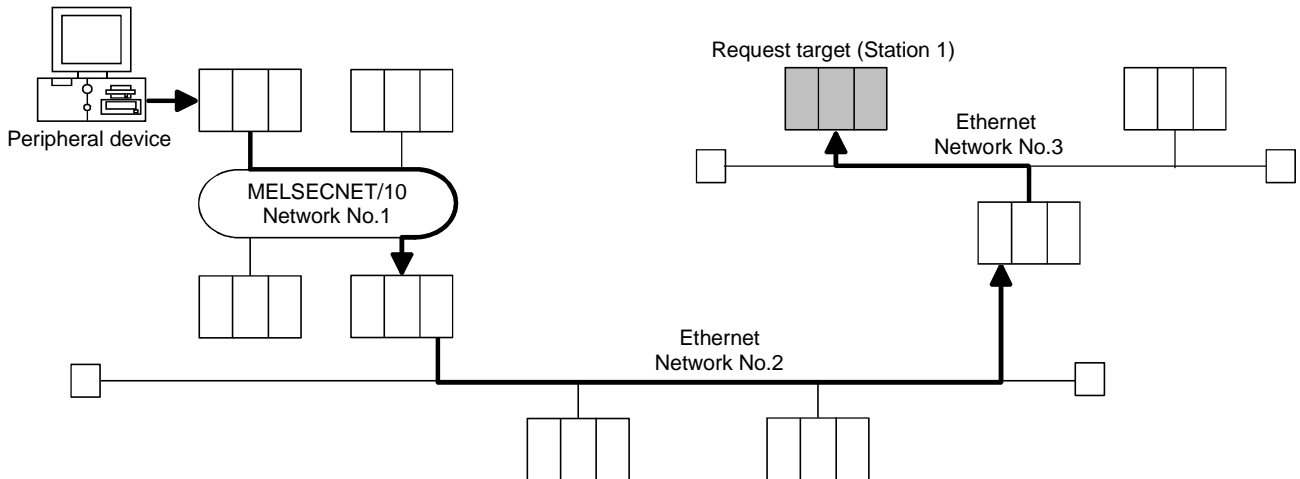

For access to the other station or multilevel system, not only the Connection Setup but also the routing parameters should be set to enable communications.

Screen setting for MELSECNET/H, MELSECNET/10 and C24 mixed system (Coexistence network)

Specify Coexistence network when accessing the other station via different networks, e.g. from MELSECNET/H, MELSECNET/10 to Q-compatible C24/QC24.

An example of the Connection Setup setting screen is provided for the following system configuration (Q/QnA only).

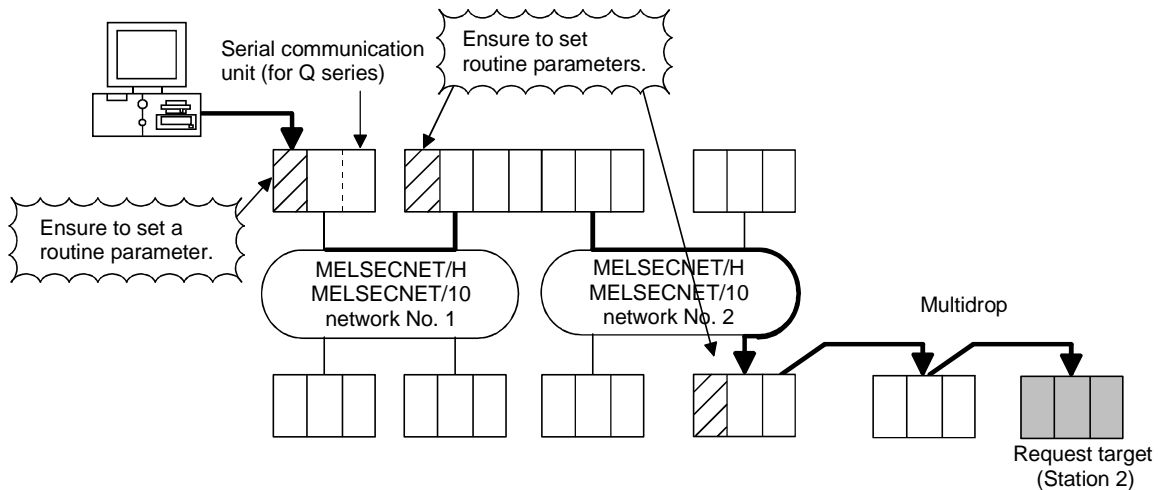

The screenshot shows the 'Connection Setup' software interface. The main window has several sections: 'PC side I/F', 'PLC side I/F', 'Other station', 'Network route', and 'Coexistence network route'. Callouts from the diagram point to specific settings in these sections:

- PC side I/F Serial setting:** Shows 'COM1' selected, 'COM port' set to 'COM 1', and 'Baud rate' set to '19.2Kbps'.
- PC side I/F detailed setting of C24:** Shows 'CPU type' set to 'QJ71C24', 'Station No.' set to '0', 'Parity' set to 'Odd', and 'Sum check' set to 'Existence'.
- Other station Detailed setting:** Shows 'Check at communication time' set to '30' sec and 'Retry times' set to '0'.
- Network communication route Detailed setting of MNET/10:** Shows 'Network No.' set to '0' and 'Station No.' set to '1'.
- Coexistence network route Detailed setting of Computer I...:** Shows 'Head I/O' set to '0' and 'Station No.' set to '0'.

REMARK

- (1) Precautions are indicated for when accessing to other station like the following system example.

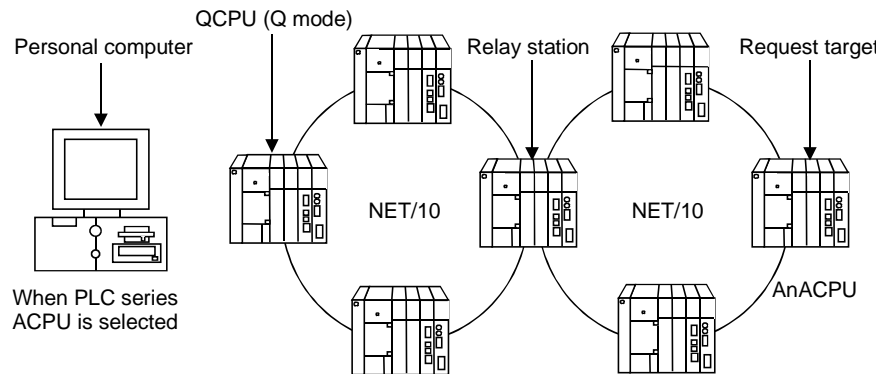

- (a) Change the personal computer to the PLC type of the request target. Communication cannot be made if the PLC type differs.
- (b) The relay station used should be the QCPU (Q mode), AnUCPU.

7.1.3 Accessing multiple CPUs

7.1.3 (1) About access to other multiple CPU modules

(1) Purpose of operation

Specify when accessing multiple CPUs.

Setting may be made for only the function version B or later of the QCPU (Q mode)

(2) Operating Procedure

Select [Online] → [Connection setup].

(3) Dialog Box

The following setting example assumes that the personal computer is connected to the No. 1 module by a cable to access the No. 4 module.

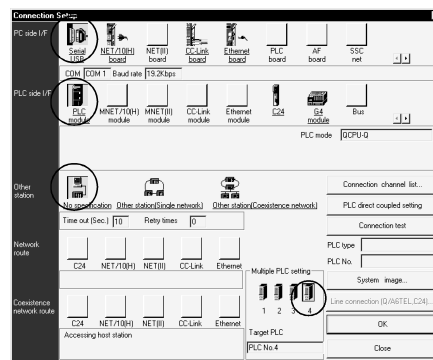

(4) Description

When accessing other than the connected PLC CPU, always specify the module No. to be accessed in Multiple PLC setting.

Note that if it is not specified in Multiple PLC setting, access will be made to the PLC CPU with which the cable is connected.

How to set "No module No. specified" in Multiple PLC setting

No module No. specified is indicated by the icons of the PLC No. 1 to PLC No. 4 modules in Multiple PLC setting which are not selected (when selected, the icons are shown yellow).

When the icons of the PLC No. 1 to PLC No. 4 modules have been selected, clicking the selected icon sets it to "No module No. specified".

An example on the above setting screen is shown by the following image sketch.

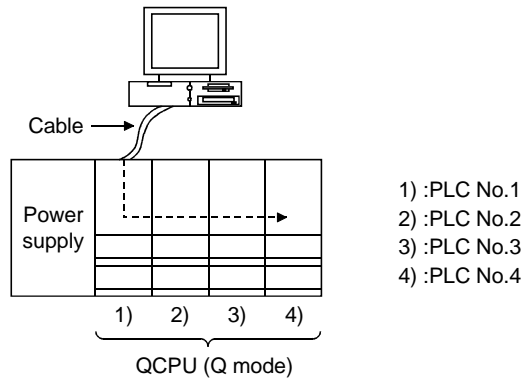

7.1.3 (2) About network access via multiple CPUs

(1) Purpose of operation

Access is made to any network station under control of the own module.
Setting may be made for only the function version B or later of the QCPU (Q mode)

(2) Operating Procedure

Select [Online] → [Connection setup].

(3) Dialog Box

The following setting assumes that access will be made to the accessed station (PLC No. 1 to PLC No. 4 modules) in [Description].

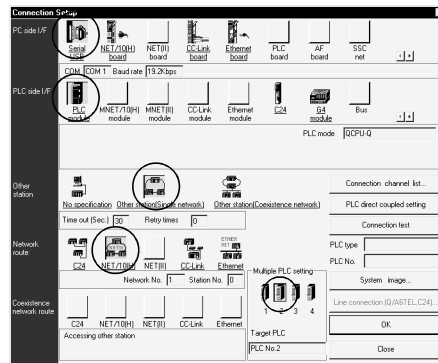

(4) Description

The concept of an access path in the following system configuration will be described.

When access is made to non-control PLC as module used for routing of the accessed other station in a Multiple CPU system, the relay modules and QCPUs of the own station, all relay stations and accessed station should be the modules of function version B.

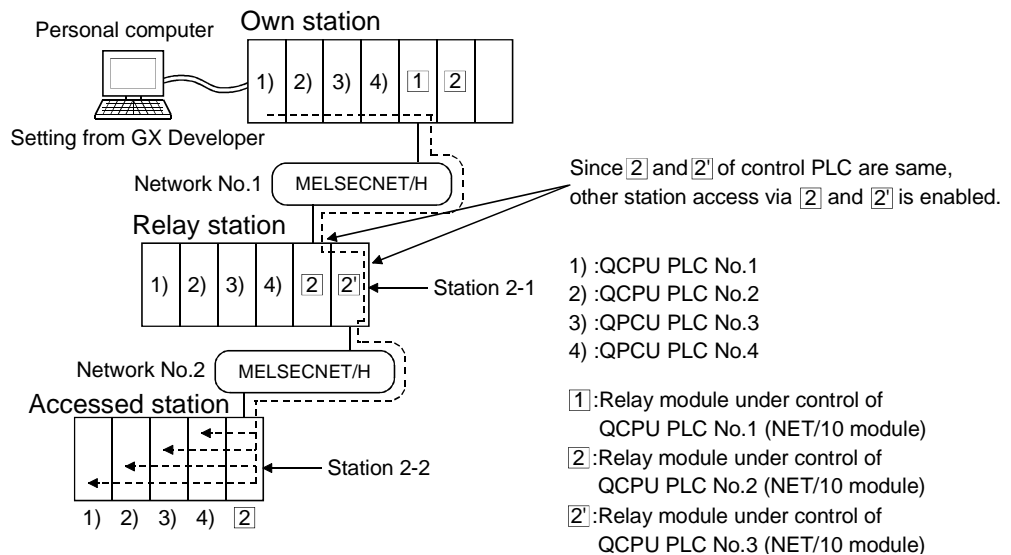

Precautions for and restrictions on access to other station

Personal computer

When making access to any of the CPUs No. 1 to No. 4 on the accessed station, select the accessed CPU in "multiple PLC designation" on the Target setup screen.

Relayed station

Make parameter setting to specify the network module (controlled by the CPU No. 2 in the above diagram) mounted on the relayed station so that the same PLC CPU controls that network module.

Accessed station

Access can be made to any of the CPUs No. 1 to No. 4 if the function version of the network module on the access station is B.

If the function version of the network module on the access station is A, access can be made to only the network module controlling CPU (No. 1).

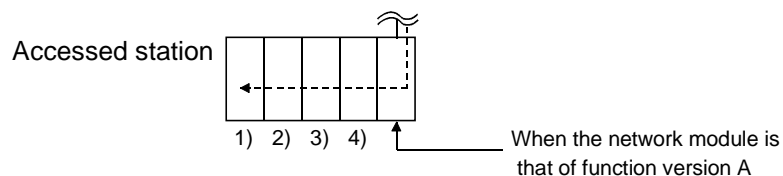

POINT

Setting the routing parameters of the MELSECNET/H, MELSECNET/10 (including Ethernet) allows access to the other station PLC within the range of the network system specifications.

POINT
<p>(1) Precautions for access to the other stations of the MELSECNET (II, /10) via the computer link unit (for A series) or E71 GX Configurator-CC recognizes the MELSECNET/10 as the MELSECNET (II) when the other stations are to be accessed via the computer link unit (for A series) or E71. When the same station exists on the MELSECNET (II) and MELSECNET/10, the other stations beyond the MELSECNET/10 may not be accessed if Via MELSECNET/10 has been selected in Connection Setup. (Because communications from the station of the unit set in the "Unit valid for other station access" network parameter are executed.) When you want to access all other stations via the computer link unit (for A series) or E71, do not set the same station number on the networks.</p> <p>(2) When the MELSECNET/10 /CC-Link card is used, the time check is fixed to 30 seconds.</p> <p>(3) A communications error may occur if communications are made with the PLC after setting the resume function, suspend setting, power-saving function or standby mode of the personal computer. Hence, any of the above functions should not be set for making communications with the PLC.</p> <p>(4) Connecting/disconnecting the USB cable, resetting the PLC, or switching power OFF/ON frequently during communications with the PLC can cause a communications error, from which recovery may not be made. Hence, place GX Configurator-CC in an offline status where possible before connecting/disconnecting the USB cable, resetting the PLC, or switching power OFF/ON. If recovery cannot be made from the communications error, completely disconnect the USB cable once and reconnect it in more than five seconds. (Even after this operation, an error may occur at the initial communication, but communications will be made properly at the second time and later.)</p> <p>(5) Communication errors may occur depending on the type of personal computer used or USB cable assembly In this case. Please execute communication again according to the error message contents.</p> <p>(6) When fast communication is made after the baud rate has been changed on the personal computer's serial port (personal computer side interface), communications may not be made or communications retries may take place to delay communications, depending on the performance of the personal computer. If communications cannot be made in fast communication, reduce the baud rate and make communication.</p>

POINT

(7) Do not reset the PLC CPU when starting GX Developer on Windows® 2000 and making communications with the PLC CPU using the USB cable.
If you reset the PLC CPU during communications using the USB cable, the following dialog box will appear and the USB driver will be removed.

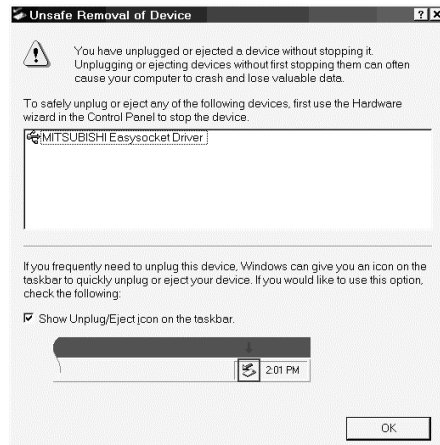

Take the following action when the above dialog box has appeared.

- Click the **OK** button and remove the USB driver once.
To make communication again, install the USB driver.
Refer to Section 3.4 for the installation procedure.

7.2 Reading the Parameters from the Master Module (AJ61BT11, A1SJ61BT11 only)

- (1) Purpose of operation
Read the parameters from the master module.
- (2) Operation procedure
Perform any of the following operations.
 - Choose [Online]—[Upload master parameter...] menu.
 - Press the "Alt" + "U" keys.
- (3) Explanation
Preset the connection target.
Refer to Section 7.1 for the way to set the connection target.

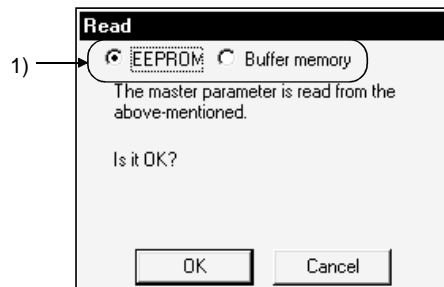

Item	Description
1) Read destination	Set whether read will be performed from E ² PROM or buffer memory of the master module.
"OK" button	Used to execute read. After completion of read, perform operation in accordance with the screen messages.
"Cancel" button	Used to stop read and close this screen.

POINTS
(1) Note that read from E ² PROM will perform the following operations. <ul style="list-style-type: none"> • The E²PROM parameters overwrite the buffer memory parameters. • The E²PROM parameter settings are used to start data link automatically. (2) Perform this operation while the PLC CPU is at STOP. If it is performed during RUN, data link may start and output provided to the external equipment.

7.3 Writing the Parameters to the Master Module (AJ61BT11, A1SJ61BT11 only)

- (1) Purpose of operation
Write the parameters to the master module.
- (2) Operation procedure
Perform any of the following operations.
 - Choose [Online]—[Download master parameter...] menu.
 - Press the "Alt" + "A" keys.
- (3) Setting screen
Preset the connection target.
Refer to Section 7.1 for the way to set the connection target.

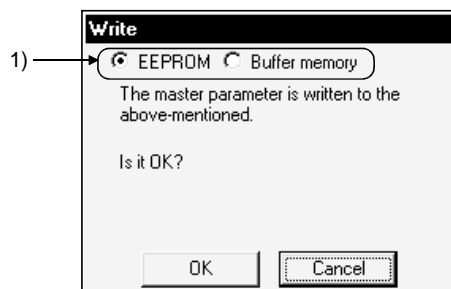

Item	Description
1) Write destination	Set whether write will be performed to E ² PROM or buffer memory of the master module.
"OK" button	Used to execute write. After completion of write, perform operation in accordance with the screen messages.
"Cancel" button	Used to stop write and close this screen.

POINTS
(1) To write the parameters to E ² PROM, the buffer memory parameters will be overwritten.
(2) Perform this operation while the PLC CPU is at STOP.

7.4 Verifying the Parameters between Master Module and GX Configurator-CC (AJ61BT11, A1SJ61BT11 only)

- (1) Purpose of operation
Verify the parameters between the master module and GX Configurator-CC.
- (2) Operation procedure
Perform any of the following operations.
 - Choose [Online]—[Verify master parameter...] menu.
 - Press the "Alt" + "Q" keys.
- (3) Setting screen
Preset the connection target.
Refer to Section 7.1 for the way to set the connection target.

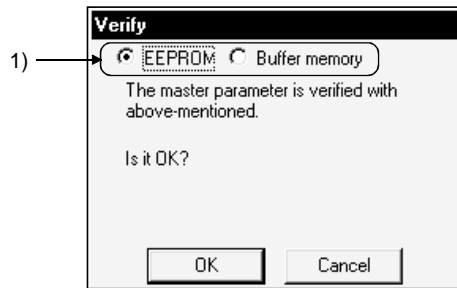

Item	Description
1) Verify destination	Set whether verify will be performed with E ² PROM or buffer memory of the master module.
"OK" button	Used to execute verify. After completion of verify, perform operation in accordance with the screen messages.
"Cancel" button	Used to stop verify and close this screen.

POINTS
(1) Note that verify with the E ² PROM parameters will perform the following operations. <ul style="list-style-type: none"> • The E²PROM parameters overwrite the buffer memory parameters. • The E²PROM parameter settings are used to start data link automatically. (2) Perform this operation while the PLC CPU is at STOP. If it is performed during RUN, data link may start and output provided to the external equipment.

7.5 Reading the Version of the Master Module

- (1) Purpose of operation
Read the software version or function version of the master module.
- (2) Operation procedure
Perform either of the following operations.
 - Choose [Online]—[Master module version information...] menu.
 - Press the "Ctrl" + "B" keys.
- (3) Setting screen
Preset the connection target.
Refer to Section 7.1 for the way to set the connection target.

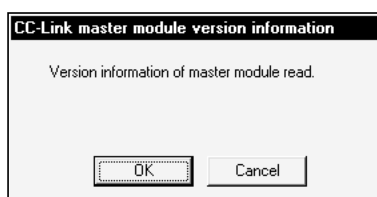

Item	Description
"OK" button	Used to read the software version or function version of the master module.
"Cancel" button	Used to stop version information read and close this screen.

7.6 Monitoring/Testing RX, RY, RWw and RWr of a Remote Station

(1) Purpose of operation

Monitor and test RX, RY, RWw and RWr of the specified remote station.
This operation may be used on only the master station.

POINT	Before starting the operations in this section, make sure that the mode setting switch of the master/local module is in the online position.
--------------	--

(2) Operation procedure

Perform any of the following operations.

- Choose the [Online]—[Remote station monitor/test...] menu.
- Press the "Alt" + "R" keys.

(3) Setting screen

Preset the connection target.

Refer to Section 7.1 for the way to set the connection target.

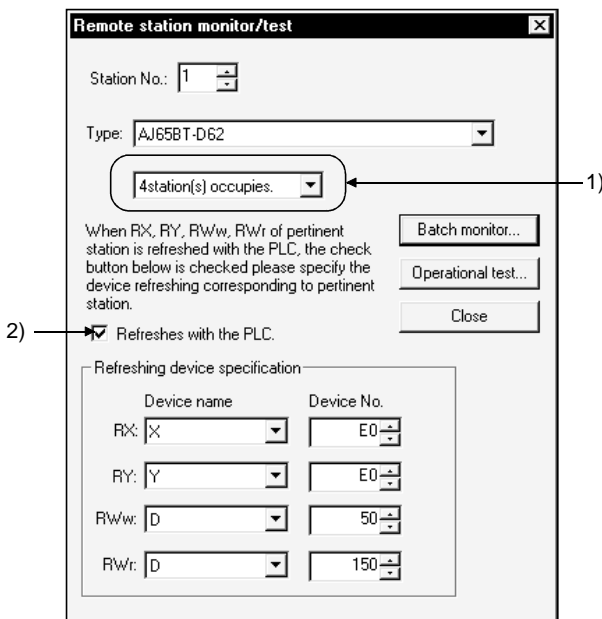

Item	Description
Station No.	Set the remote station number which will be monitored/tested. If the remote station type set in Type and the station number specified in this item are not correct, correct information cannot be monitored/tested.
Type	Choose the type for the station number to be monitored/tested.

Item	Description
1) Number of stations occupied	Set the actual number of occupied stations when the remote station can be changed in occupied station count setting, e.g. GOT.
2) Refresh designation	<p>When the FROM/TO instruction or CC-Link-dedicated instruction (RRPA instruction) or automatic refresh parameters is used to refresh RX, RY, RWw and RWr of the corresponding station from the PLC CPU, check this check box and specify the refreshed devices.</p> <p>However, when the FROM/TO instruction is used and the PLC CPU is at STOP, you need not check this check box as refresh is not made.</p>
Refreshing device specification	
Device name	<p>Specify the refreshed device names.</p> <p>Set "Not specified" for the devices not refreshed.</p> <p>If they are not set correctly, correct information cannot be monitored/tested.</p>
Device No.	<p>Set the device numbers of the refreshed device names.</p> <p>If they are not set correctly, correct information cannot be monitored/tested.</p>
"Batch monitor" button	<p>Click this button to batch-monitor the information of the specified remote station. Clicking shows the "Monitor of batch of RX/RX/RWw/RWr" screen.</p> <p>Refer to Section 7.6.1.</p>
"Operational test" button	<p>Click this button to write values to RWw of the remote station or read the RWr values. Clicking shows the "Remote station operational test" screen.</p> <p>Refer to Section 7.6.2.</p> <p>If RWw or RWr does not exist or an unused remote station is selected, this button is grayed and cannot be clicked.</p>
"Close" button	Used to close this screen.

7.6.1 Performing batch monitor/test

- (1) Purpose of operation

You can batch-monitor the information of the specified remote station.
You can also change the RY and RWw values.
- (2) Operation procedure
 - (a) Perform either of the following operations.
 - Choose the [Online]-[Remote station monitor/test...] menu.
 - Press the "Alt" + "R" keys.
 - (b) After choosing the remote station type on the "Remote station monitor/test" screen, click the "Batch monitor" button.
- (3) Setting screen

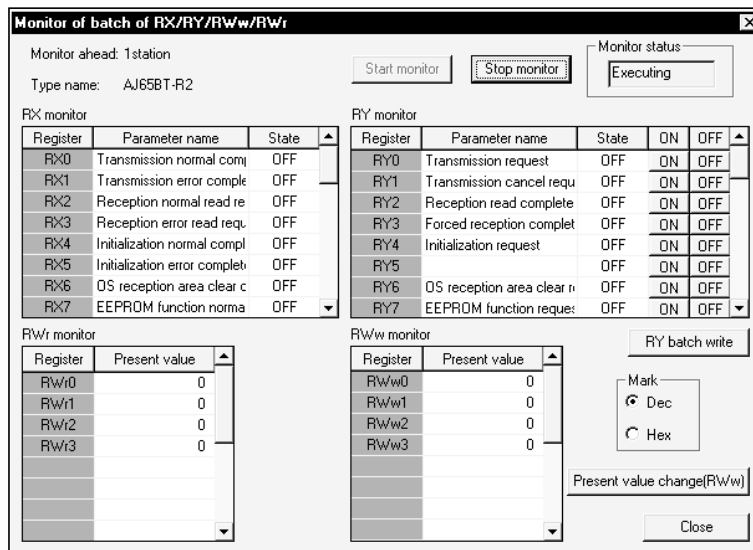

Item	Description
"Start monitor" button	Used to start monitoring of RX, RY, RWw and RWr.
"Stop monitor" button	Used to stop monitoring of RX, RY, RWw and RWr.
Monitor status	Shows the present monitor status.
Register	Shows the registers being monitored (RX, RY, RWw, RWr). Specifying the refreshed devices shows the devices refreshed.
Parameter name	Shows the RX and RY signal names being monitored.
State	Shows the current states of RX and RY.
"ON" button	Click this button to turn on RY displayed on the left of the button.
"OFF" button	Click this button to turn off RY displayed on the left of the button.

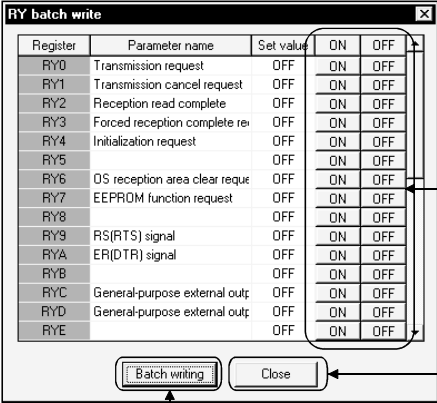
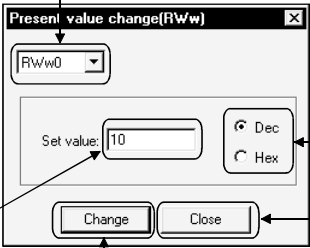
Item	Description
<p>"RY batch write" button</p>	<p>Click this button to batch-change the ON/OFF data of RY. Clicking shows the following screen.</p>  <p>Used to batch-write to the remote station the data set to Set value.</p>
<p>Present value</p>	<p>Shows the present values of RWw and RWr.</p>
<p>Mark</p>	<p>Set whether the present values are displayed in decimal or hexadecimal.</p>
<p>"Present value change (RWw)" button</p>	<p>Clicking shows the following screen. Also, double-clicking the present value shows the following screen.</p> <p>Set RWw to be changed in value.</p>  <p>Set a new value.</p> <p>Choose whether the new value is specified in decimal or hexadecimal.</p> <p>Used to execute change.</p> <p>Used to close this screen.</p>
<p>"Close" button</p>	<p>Used to close this screen.</p>

7.6.2 Performing operational tests

**CAUTION**

- Read the manual carefully before performing the online operation which will be executed with the peripheral device connected to the running module.
Not doing so can damage the machine or cause an accident due to misoperation.

(1) Purpose of operation

The following remote stations can use the operational test.

Remote Station Type	Purpose of Operation	Reference Operation Example *1
AJ65BT-64AD	(1) You can write a value to RWw per RWw item. (2) Batch-read the RWr data.	(a)
AJ65BT-64DAI		
AJ65BT-64DAV		
AJ65BT-68TD		
AJ65BT-D62		
AJ65BT-D62D		
AJ65BT-D62D-S1		
AJ65BT-D75P2-S3		
AJ65BT-64RD3	Batch-read the RWr data.	
AJ65BT-64RD4		
A852GOT-LBD	(1) Execute the following GOT-dedicated commands. <ul style="list-style-type: none"> • Initial setting • Continuous read • Random read • Continuous write • Random write • Monitor registration • All-time write registration 	(b)
A852GOT-LWD		
A852GOT-SBD		
A852GOT-SWD		
A8GT-J61BT15		
FREQROL-A500	(1) Perform the following operations to the inverter. <ul style="list-style-type: none"> • Frequency setting • Operation mode write/read • Error history read • Set frequency write/read • Parameter write/read • Alarm definition batch clear • All parameter clear • Inverter reset • Link parameter expansion setting write/read • Second parameter switch-over write/read 	(c)
FREQROL-E500		
FREQROL-F500		
MR-H10-22k TN (positioning system)	(1) Using the instruction codes of the AC servo, perform write/read of various data. (2) Batch-read the RWr data.	
MR-H10-22k TN (roll system)		

*1 Indicates the setting example numbers in (4) of this section whose operation methods may be used as reference.

(2) Operation procedure

(a) Perform any of the following operations.

- Choose the [Online]—[Remote station monitor/test] menu.
- Press the "Alt" + "R" keys.

(b) After choosing the remote station type on the "Remote station monitor/test" screen, click the "Operational test" button.

(3) Operation procedure

POINTS

- Before starting operation on this screen, make sure that data link started properly and the remote ready signal of the remote station is on.
This function cannot be used unless data link has started properly and the remote ready signal is on.
You can check the data link status on the network monitor/test screen and check the remote ready signal on the remote station monitor/test batch monitor screen.
- Make initial settings before testing the remote station which requires initial settings to be made with a sequence program.

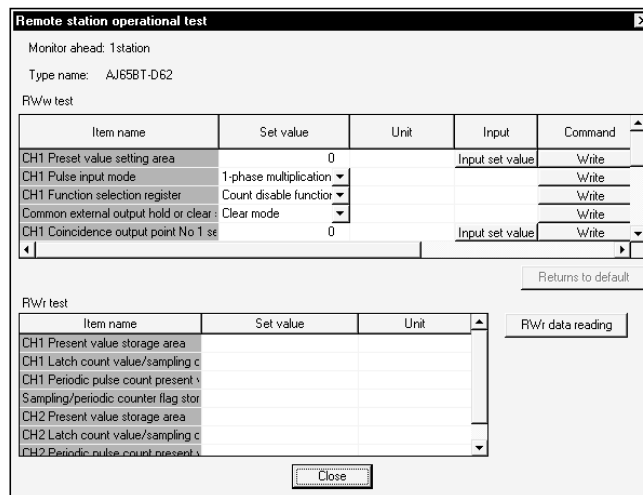

Item	Description
Item name	Shows the data of the remote registers (RWw, RWr) of the remote station with item names.
Set value	Shows the values set to RWw and RWr. If there is a RWw set value list box, set any value, then click the "Write" button to set the value to the remote station.
Unit	Shows the units of the set values.

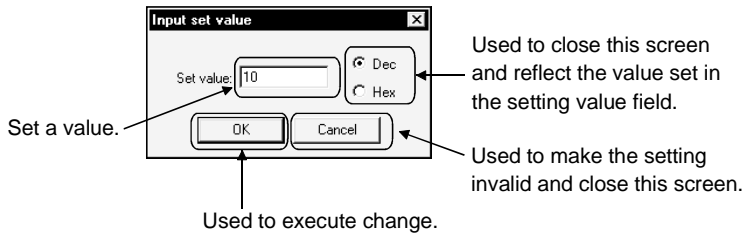
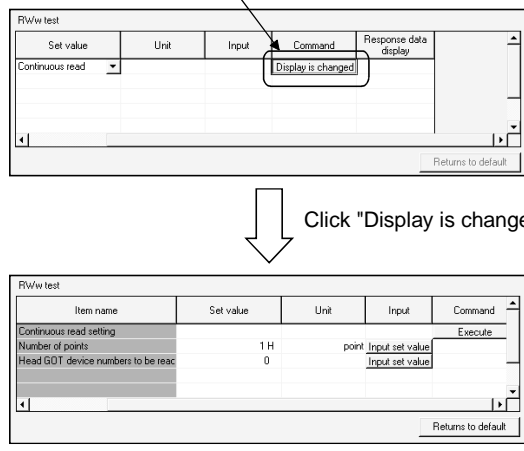
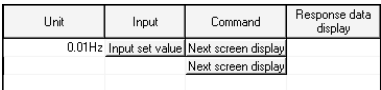
Item	Description
<p>Input</p> <p>When "Input set value" button is displayed</p>	<p>You can show the following screen and change the set value.</p> 
<p>Command</p>	<p>You can write the set value to the remote station.</p>
<p>When "Write" button is displayed</p> <p>When "Display is changed" button is displayed</p>	<p>Appears when details must be set for the data set in Set value. Clicking changes to the detail screen for the data set in Set value.</p>  <p>Click "Display is changed" button!</p> <p>Screen changes.</p>
<p>When "Next screen display" button is displayed</p>	<p>Clicking shows the "Parameter details setting and execution" screen in (b).</p> 

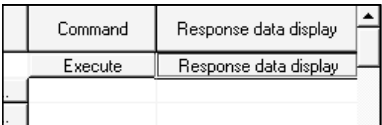
Item	Description
Response data display	<p>The "Rwr data reading" button appears when response data exist in the data read from the remote station.</p> <p>Clicking shows the "RWr data display" screen in (a).</p> 
"Returns to default" button	Used to return to the previous screen when the "Display is changed" button was clicked to change the on-screen display.
"RWr data reading" button	Used to read data from RWr of the remote station.
"Close" button	Use to close this screen.

(a) "RWr data display" screen

You can check the details of RWr.

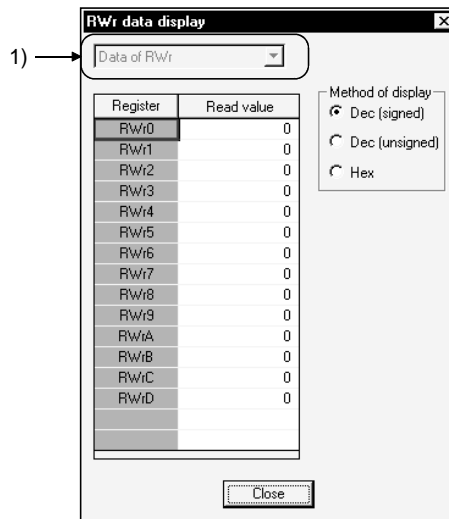

Item	Description
1) Display data change	Change the data to be displayed on this screen.
Method of display	Choose the read value display method from among decimal (signed), decimal (unsigned) and hexadecimal.
Register	Shows the register names corresponding to the values displayed in Register.
Read value	Shows the read values corresponding to the register names. The display format changes with the display method.
"Close" button	Used to close this screen.

(b) "Parameter details setting and execution" screen

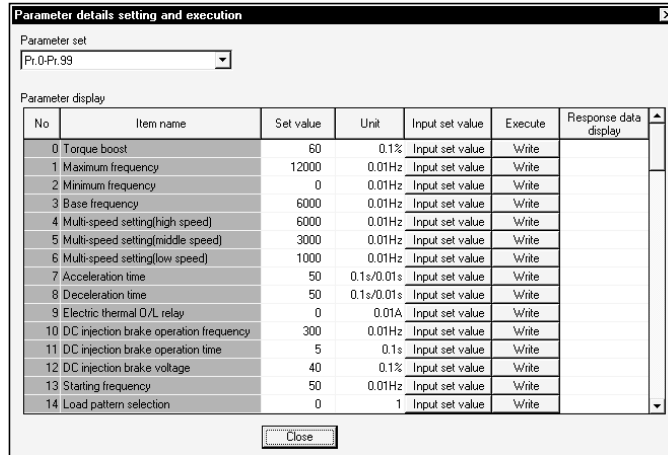

Item	Description
No	Shows the parameter numbers of the inverter.
Item name	Shows the names of the accessible parameters.
Set value	Shows the values to be written to RWw. Set the value by clicking the "Input set value" button.
Unit	Shows the units of the set values.
Input set value	<p>You can show the following screen and change the set value.</p>
Execute	
When "Write" button is displayed	Writes the set value to the remote station.
When "Read" button is displayed	<p>Reads the RWr data from the remote station.</p>
Response data display	<p>The "Response data display" button appears when response data exist in the data read from the remote station. Clicking shows the "RWr data display" screen in (a).</p>

(4) Setting examples

For details of the settings, refer to the user's manual of the corresponding remote station.

(a) When the AJ65BT-64AD is used, set channel 3 to time-based average processing and the preset time to 1000ms.

- Module type: AJ65BT-64AD, station number: 4

1) Specify "Average processing" in Set value of Average processing/Sampling processing CH3 and click the "Write" button.

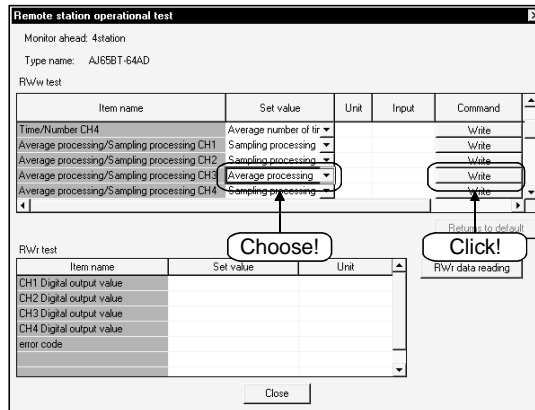

2) Specify "Average time" in Set value of Time/Number CH3 and click the "Write" button.

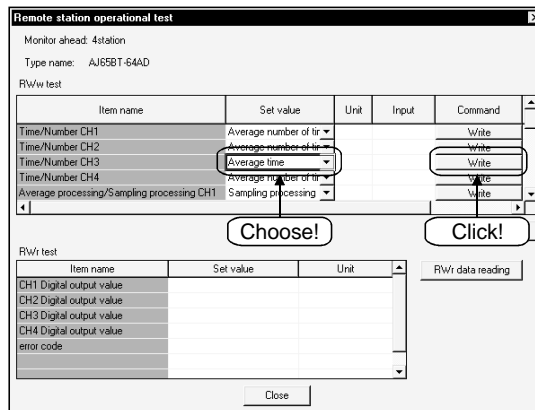

3) Click the "Input set value" button of CH3 average time/average number of times and specify "1000 (1000ms)" in Set value.

After setting, click the "Write" button.

This sets channel 3 to time-based average processing of 1000ms preset time.

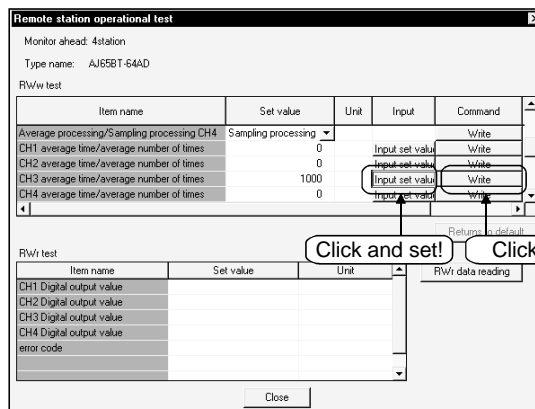

(b) When the A852GOT is used, read the GD100, GD200 and GD300 values with the random read command.

- Module type: A852GOT-LWD, station number: 7

POINT

When executing a dedicated command for the GOT, the initial setting command must be executed first to switch to the dedicated command-based monitor mode. For more information, refer to the A852GOT graphic operation terminal user's manual.

1) Specify "Random read" in Set value of Command and click the "Display is changed" button.

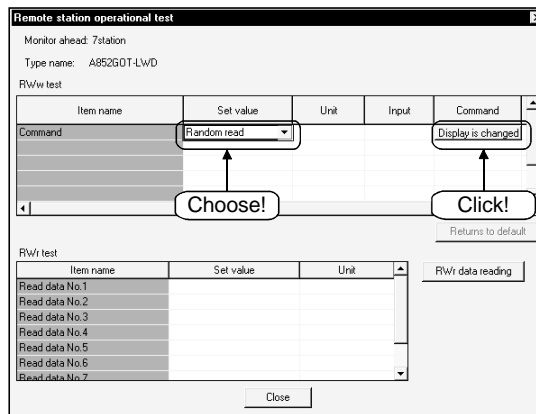

2) When the screen has changed, set the number of read points. Click the "Input set value" button in the Number of points field and set the number of points.

Here, set "3" as three points will be read.

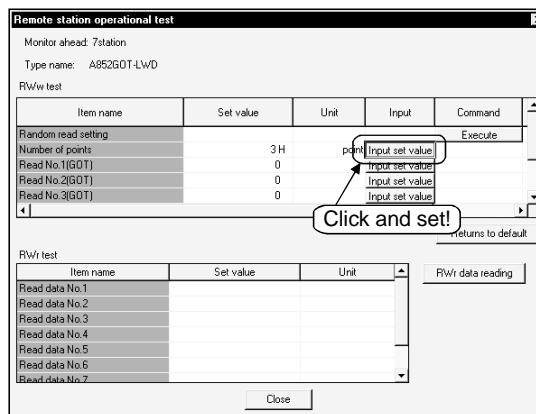

3) Set the read address.

Click the "Input set value" button of Read No. 1 to 3 (GOT) and make the following setting.

When setting is complete, click the "Execute" button to execute read.

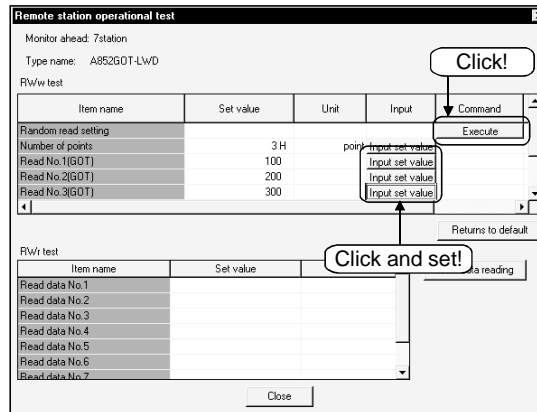

* Set the GD values of the GOT internal devices in Read No.s (GOT).

4) When read is complete, the "Response data display" button appears. Click it to check the RWr data.

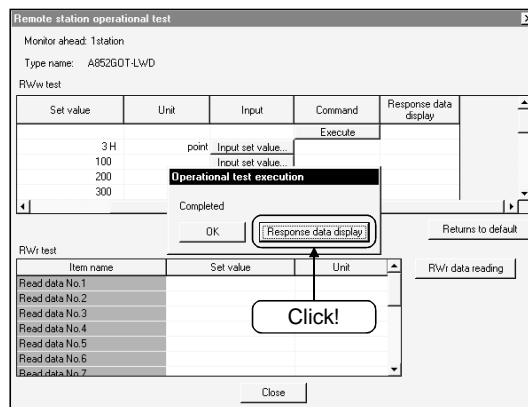

5) You can check the GD100, GD200 and GD300 values.

Reading GD stores the values in due order from top to bottom, beginning with RWr0. By checking the following RWr, you can check the read values.

RWr0: GD100 value, RWr1: GD200 value, RWr2: GD300 value

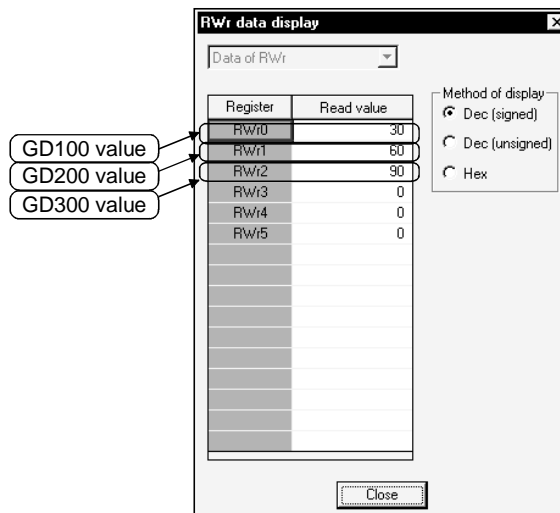

(c) When the FR-A520-0.4K and FR-A5NC are used, change the maximum frequency (Pr. 1) to 80Hz (Parameter value change)

- Unit type: FREQRDL-A500(0.4), station number: 1

1) Specify "Parameter write" in Set value of Instruction code and click the "Next screen display" button.

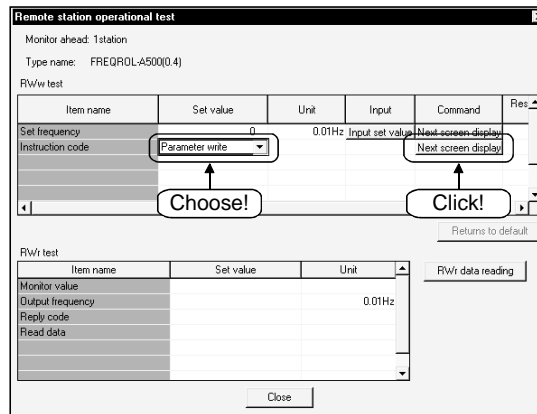

2) As the maximum frequency in Pr. 1 is set, set "Pr. 0 – Pr. 99" in the Parameter set list box.

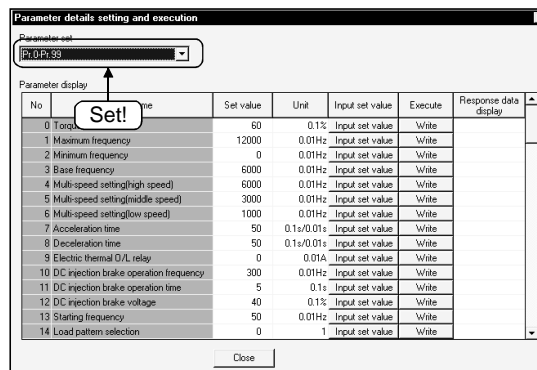

3) Click the "Input set value" button of Maximum frequency (Pr. 1) and specify "8000 (80Hz)" in Set value.

Clicking the "Write" button after setting sets 80Hz to the maximum frequency (Pr. 1).

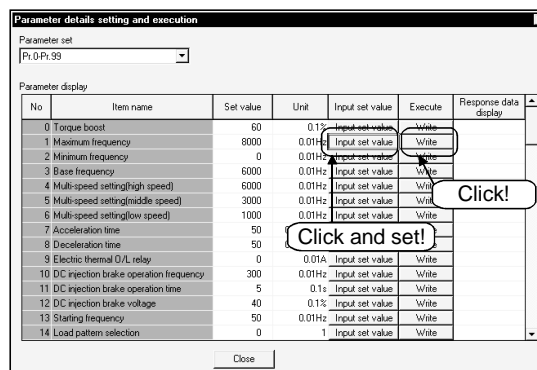

7.7 Monitoring/Testing the Communication Status of CC-Link (When using AJ61BT11 or A1SJ61BT11)

POINT
 Monitor/test can be used when the mode setting switch of the master/local module is in the online position.

7.7.1 Monitoring the network status

- (1) Purpose of operation
 You can check the network status of CC-Link.
- (2) Operation procedure
 Perform any of the following operations.
 - Choose the [Online]—[Network monitor/Test...] menu.
 - Press the "Alt" + "M" keys.
- (3) Setting screen
 Preset the connection target.
 Refer to Section 7.1 for the way to set the connection target.

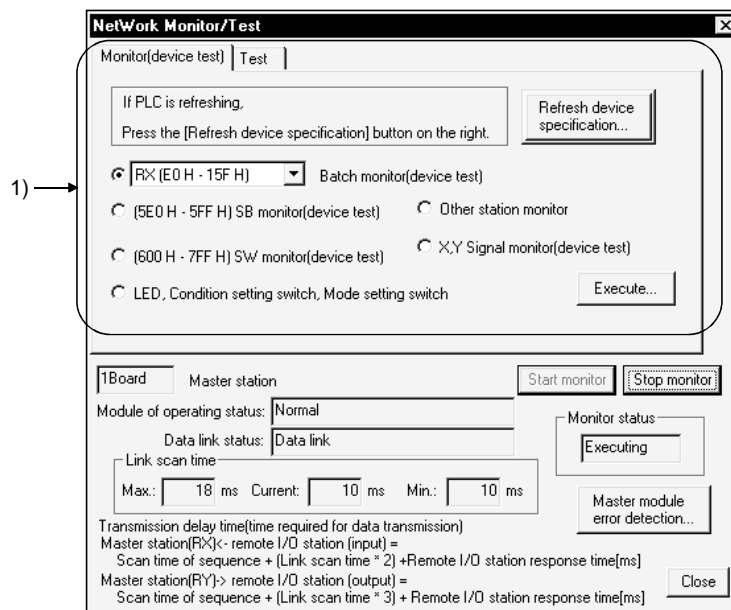

Item	Description
1) Monitor/test screen	Refer to Section 7.7.2 for the "monitor (device test)" screen. Refer to Section 7.7.3 for the "test" screen.
"Start monitor" button	Used to start network monitoring.
"Stop monitor" button	Used to stop network monitoring.
Monitor status	Shows the present monitor status.
Module of operating status	Shows the operating status of the master module.
Data link status	Shows the data link status.

Item	Description
Link scan time	Shows the link scan time.
"Master module error detection" button	You can set the switch setting, parameter and loading status errors of the master module. Clicking this button shows the "Master module error detection" screen in (a).
Transmission delay time	Shows the expression for calculating the transmission delay time between the master and remote I/O stations.
"Close" button	Used to close this screen.

(a) "Master module error detection" screen

Shows the error codes and error definitions as to the switch setting, parameter and loading status of the master module. Clicking the "Detail error" button opens the help file corresponding to the error code.

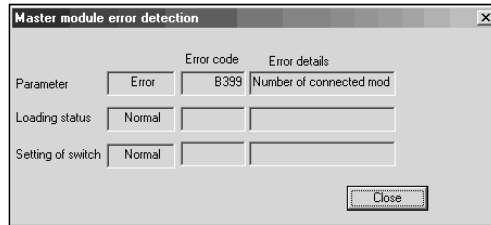

7.7.2 Monitoring the devices, LEDs and switches

(1) Purpose of operation

Monitor the LED and switch states of the module (master, standby master or local station) set in Transfer setup, monitor other stations, and test such devices as RX and RY.

(2) Operation procedure

Perform any of the following operations.

- Choose the [Online]—[Network monitor/Test] menu.
- Press the "Alt" + "M" keys.

(3) Setting screen

Preset the connection target.

Refer to Section 7.1 for the way to set the connection target.

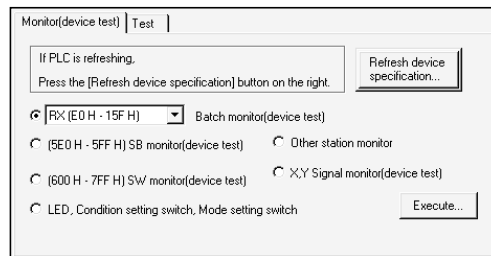

Item	Description
"Refresh device specification" button	Clicking this button shows the "Refresh device specification" screen in (a). When the PLC CPU is refreshing RX, RY, RWw, RWr, SB and/or SB using the FROM/TO instruction or CC-Link-dedicated instruction (RRPA instruction), click this button and specify the refreshed devices. * Make this setting before starting monitoring. If you click this button during monitoring, you cannot perform "refresh device specification".
Batch monitor (device test)	Choose when batch-monitoring RX, RY, RWw or RWr. Clicking the "Execute" button after making selection shows the "Batch monitor" screen in (b).
(5E0H - 5FFH) SB monitor (device test)	Choose when monitoring SB. Clicking the "Execute" button after making selection shows the "SB monitor(device test)" screen in (c).
(600H - 7FFH) SW monitor (device test)	Choose when monitoring SW. Clicking the "Execute" button after making selection shows the "SW monitor(device test)" screen in (d).
LED, Condition setting switch, Mode setting switch	Choose when monitoring the states of the LEDs, condition setting switches and mode setting switch of the module set in Transfer setup. Clicking the "Execute" button after making selection shows the "LED, Condition setting switch, Mode setting switch monitor" screen in (e).

Item	Description
Other station monitor	Choose when monitoring the other station states (e.g. error invalid and reserved stations). Clicking the "Execute" button after making selection shows the "Other station monitor" screen in (f). Note that data link must have been started.
X,Y Signal monitor (device test)	Choose when monitoring the X and Y states of the module set in Transfer setup. Clicking the "Execute" button after making selection shows the "X,Y Signal monitor" screen in (g).
"Execute" button	Used to execute monitor (device test) selected with the radio button.

(a) "Refresh device specification" screen

Used to set the refreshed device names and device numbers of RX, RY, RWw, RWr, SB and SB using the FROM/TO instruction or CC-Link-dedicated instruction (RRPA instruction).

If they are not set correctly, correct information cannot be monitored.

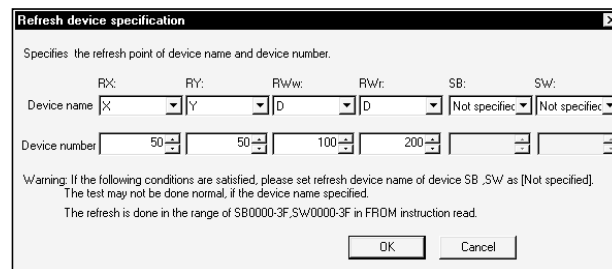

Item	Description
Device name	Set the refreshed device names. Set "Not specified" to the devices not refreshed.
Device number	Set the device numbers of the refreshed device names.
"OK" button	Used to determine the settings and close this screen.
"Cancel" button	Used to close this screen without setting the refresh devices.

POINT

When the FROM/TO instruction is used and the PLC CPU is at STOP, refresh is not made and the settings on this screen are not necessary.

(b) "Batch monitor" screen

Used to batch-monitor the RX, RY, RWw or RWr states.

The refreshed devices are monitored if the refreshed devices were specified on the "Refresh device specification" screen.

If the refreshed devices were not specified, the buffer memory of the module set in Transfer setup is monitored.

1) RX/RY batch monitor screen

If the word device was specified on the "Refresh device specification" screen, the screen appears in the display format shown in 2).

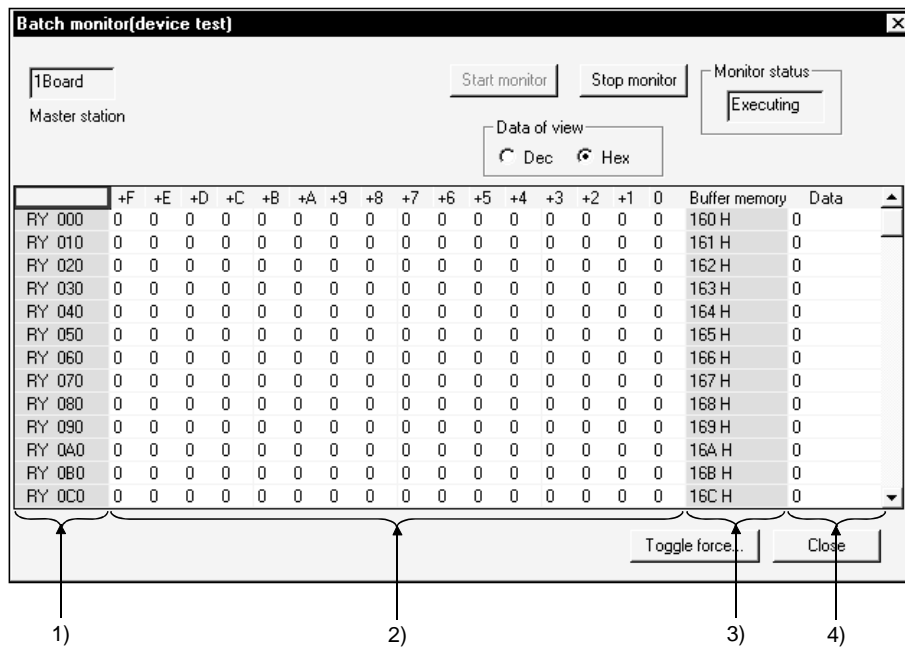

Item	Description
"Start monitor" button	Used to start monitor.
"Stop monitor" button	Used to stop monitor.
Data of view	Set whether the data are displayed in decimal or hexadecimal.
Monitor status	Shows the current monitor status.
1) Monitored devices	Shows the monitored devices. The refreshed devices appear when the refreshed devices were set on the "Refresh device specification" screen. RX or RY numbers are displayed when the refreshed devices are not set.
2) ON/OFF states	Shows the ON/OFF states of the monitored devices. 1: ON 0: OFF
3) Buffer memory addresses	Shows the buffer memory addresses corresponding to RX/RY when the refreshed devices were not set on the "Refresh device specification" screen.
4) Data	Shows the 16-bit data in the display format set in "Data of view".

Item	Description
<p>"Toggle force" button</p>	<p>This button appears only when RY is monitored. You can display the following screen and change the present value. The following screen is also displayed by double-clicking the ON/OFF status field 2) of the screen.</p> <div style="text-align: center;"> </div>
<p>"Close" button</p>	<p>Used to close this screen.</p>

2) RWw/RWr batch monitor screen

If the bit device was specified on the "Refresh device specification" screen, the screen appears in the display format shown in 1).

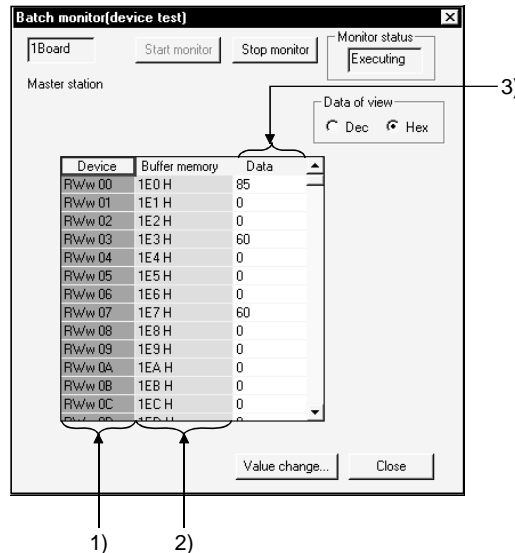

Item	Description
"Start monitor" button	Used to start monitor.
"Stop monitor" button	Used to stop monitor.
Data of view	Set whether the data are displayed in decimal or hexadecimal.
Monitor status	Shows the current monitor status.
1) Monitored devices	Shows the monitored devices. The refreshed devices appear when the refreshed devices were set on the "Refresh device specification" screen. RWw or RWr numbers are displayed when the refreshed devices are not set.
2) Buffer memory addresses	Shows the buffer memory addresses corresponding to RWw/RWr when the refreshed devices were not set on the "Refresh device specification" screen.
3) Data	Shows the 16-bit data in the display format set in "Data of view". Double-clicking during RWw monitoring shows the Value change screen.
"Value change" button	This button appears only when RWw is monitored. You can display the following screen and change the present value. <div style="display: flex; justify-content: space-between;"> <div style="width: 30%;"> <p>Set a new device (remote register).</p> <p>Set a new value.</p> </div> <div style="width: 40%; text-align: center;"> </div> <div style="width: 25%;"> <p>Choose whether the new value is specified in decimal or hexadecimal.</p> </div> </div> <p style="text-align: center;">Used to make a change. Used to close this screen.</p>
"Close" button	Used to close this screen.

(c) "SB monitor (device test)" screen

Used to batch-monitor the SB states.

The refreshed devices are monitored if the refreshed devices were specified on the "Refresh device specification" screen.

If the refreshed devices were not specified, the buffer memory of the module set in Transfer setup is monitored.

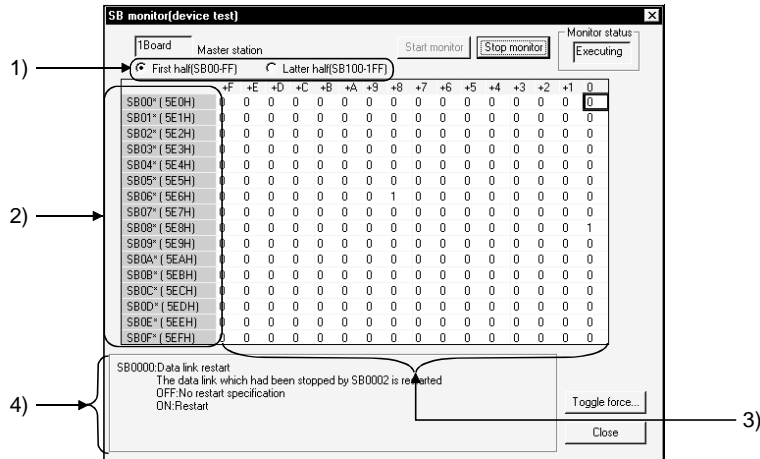

Item	Description
"Start monitor" button	Used to start monitor.
"Stop monitor" button	Used to stop monitor.
Monitor status	Shows the current monitor status.
1) First half/Latter half selection	Used to switch between the SB ranges to be monitored.
2) Monitored devices	Shows the monitored devices. The refreshed devices appear when the refreshed devices were set on the "Refresh device specification" screen. SB numbers and buffer memory addresses are displayed when the refreshed devices are not set. Any numeral of 0 to F enters "*" in "SB 00*". Example: Device in the SB 01* × +6 field = SB016
3) ON/OFF states	Shows the ON/OFF states of the monitored devices. +0 indicates bit 0, and +F bit 15. 1 : ON 0 : OFF
4) SB definition	Shows the definition of the selected SB.
"Toggle force" button	<p>You can display the following screen and change the present value.</p> <p>The following screen is also displayed by double-clicking the ON/OFF status field 2) of the screen.</p> <p>Set a new bit position only when you specified the refreshed device as the word device. This does not appear when the refreshed device was not specified or was specified as the bit device.</p> <p>Used to make a change. Used to close this screen.</p>
"Close" button	Used to close this screen.

(d) "SW monitor (device test)" screen

Used to batch-monitor the SW states.

The refreshed devices are monitored if the refreshed devices were specified on the "Refresh device specification" screen.

If the refreshed devices were not specified, the buffer memory of the module set in Transfer setup is monitored.

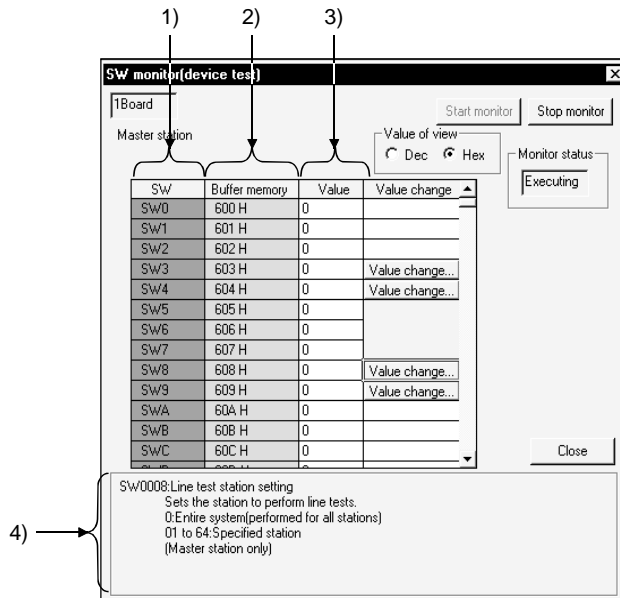

Item	Description
"Start monitor" button	Used to start monitor.
"Stop monitor" button	Used to stop monitor.
Value of view	Set whether the present values are displayed in decimal or hexadecimal.
Monitor status	Shows the current monitor status.
1) Monitored devices	Shows the monitored devices. The refreshed devices appear when the refreshed devices were set on the "Refresh device specification" screen. SW numbers are displayed when the refreshed devices are not set.
2) Buffer memory addresses	Shows the buffer memory addresses corresponding to SW when the refreshed devices were not set on the "Refresh device specification" screen.
3) Value	Shows the present values of the monitored devices.
4) SW definition	Shows the definition of the selected SW.

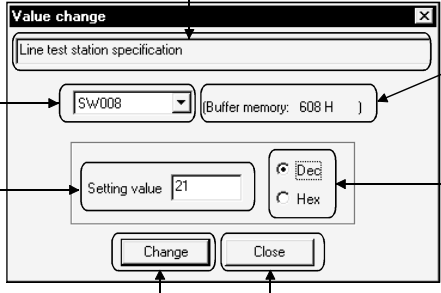
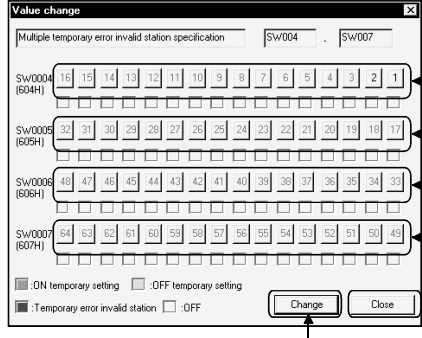
Item	Description
<p>"Value change" button</p>	<p>You can display the following screen and change the present value.</p> <ul style="list-style-type: none"> When you clicked the Value change button of SW3, SW8, SW9 or SWA <ul style="list-style-type: none"> Shows the definition of special link register.  <p>Shows the buffer memory address corresponding to SW. This is not displayed when the refreshed device is specified.</p> <p>Choose whether the new value is specified in decimal or hexadecimal.</p> <p>Used to make a change. Used to close this screen.</p> <ul style="list-style-type: none"> When you clicked the Value change button of SW4 <ul style="list-style-type: none"> Clicking the station number button sets the specified station as a temporary error invalid station. If the specified station is already set as a temporary error invalid station, its setting is canceled.  <p>Used to close this screen.</p> <p>Used to make the setting of station number button valid.</p>
<p>"Close" button</p>	<p>Used to close this screen.</p>

(e) "LED, Condition setting switch, Mode setting switch monitor" screen

You can check the states of the LEDs, condition setting switches and mode setting switch of the module set in Transfer setup.

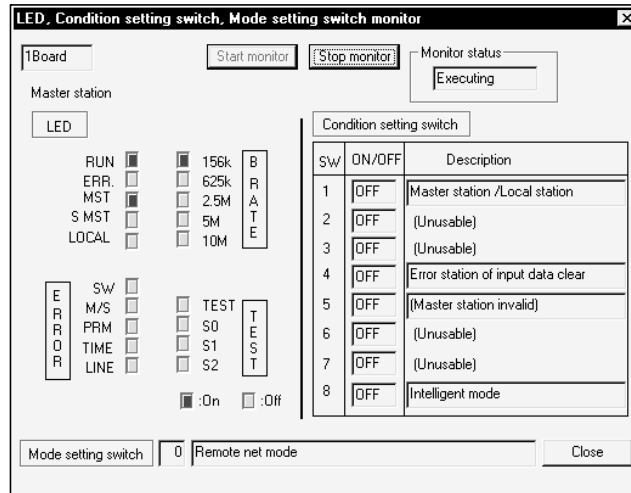

Item	Description
"Start monitor" button	Used to start monitor.
"Stop monitor" button	Used to stop monitor.
Monitor status	Shows the present monitor status.
LED	Shows the LED states on the module front.
Condition setting switch	Shows the condition setting switch states.
Mode setting switch	Shows the mode setting switch state.
"Close" button	Used to close this screen.

POINT

For the definitions of the LEDs, condition setting switches and mode setting switch, refer to the CC-Link system master/local module user's manual (details).

(f) "Other station monitor" screen

You can select the tabs to check the fuse blown status and data link status of other stations.

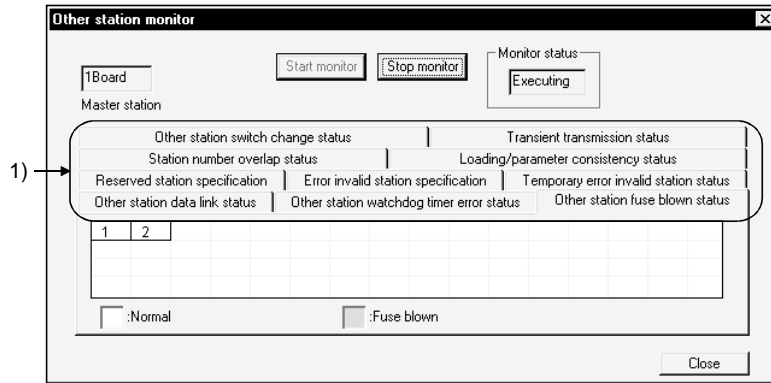

Item	Description
"Start monitor" button	Used to start monitor.
"Stop monitor" button	Used to stop monitor.
Monitor status	Shows the present monitor status.
1) Tabs	Select the tab corresponding to the status you want to monitor.
"Close" button	Used to close this screen.

(g) "X, Y signal monitor (device test)" screen

You can check the X and Y states of the module set in Transfer setup.
 You can also force Y to turn on/off.

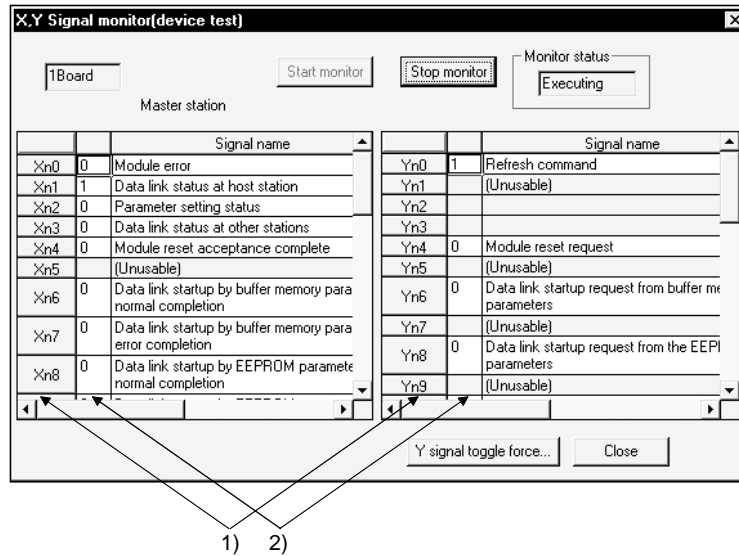

Item	Description
"Start monitor" button	Used to start monitor.
"Stop monitor" button	Used to stop monitor.
Monitor status	Shows the present monitor status.
1) Signal numbers	Shows the signal numbers of the monitored devices.
2) ON/OFF states	Shows the ON/OFF states of the monitored X and Y. 1 : ON 0 : OFF
Signal name	Shows the signal names.
"Y signal toggle force" button	<p>You can display the following screen and turn Y ON/OFF. The following screen is also displayed by double-clicking the Y ON/OFF state field 2) of the screen.</p> <div style="display: flex; align-items: center; justify-content: center;"> <div style="margin-right: 10px;">Set a new Y. →</div> <div style="margin-left: 10px;">← Choose FORCE ON or FORCE OFF.</div> </div>
"Close" button	Used to close this screen.

POINT

The usable X/Y signals vary with the version of the master/local module. For details, refer to the Master/Local Module User's Manual.

7.7.3 Conducting the network/line test

(1) Purpose of operation

Perform the network test, line test and RY output test of CC-Link.

POINT
An RY output test may be used for only the master/local module whose software version is "W" or later. Before starting an RY output test, put the PLC CPU in the STOP mode and set the master/local module's mode setting switch to "A (RY output test)".

(2) Operation procedure

Perform any of the following operations.

- Choose the [Online]—[Network monitor/Test] menu.
- Press the "Alt" + "M" keys.

(3) Setting screen

Preset the connection target.

Refer to Section 7.1 for the way to set the connection target.

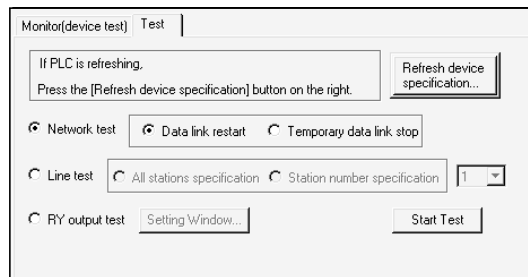

Item	Description
"Refresh device specification" button	Clicking this button shows the "Refresh device specification" screen. Refer to Section 7.7.2 (3)(a) for the operation method.
Network test	Choose when restarting or pausing data link. Choose "Data link restart" to restart data link or "Temporary data link stop" to pause data link. Clicking the "Start Test" button starts the test. If an alarm has occurred, refer to the error code and remove the error.
Line test	Specify all stations or station number and test whether data link is performed properly or not. Choose "All stations specification" to specify all stations, or choose "Station number specification" to specify the station number and set the station number to be tested. Clicking the "Start Test" button starts the test. If an alarm has occurred, refer to the error code and remove the error.
RY output test	Force the remote stations to turn on/off in a data link stop status. Clicking the "Setting Window" button shows the "RY output test output setting" screen in (a).
"Start Test" button	Used to make the selected test.

(a) "RY output test output setting" screen

Used to set forced ON/OFF of the RY of the connected remote stations. However, you cannot force the RY of the standby master station to turn on/off.

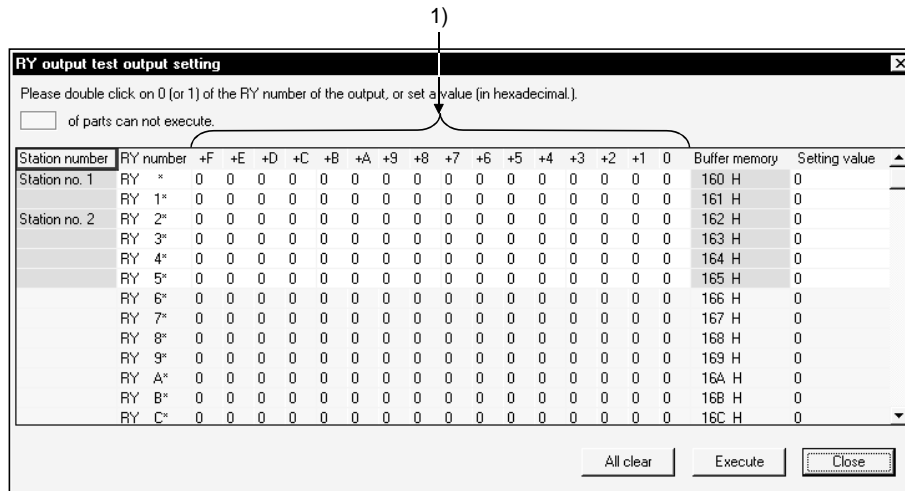

Item	Description
Station number	Shows the station numbers of the remote stations.
RY number	Shows the RY numbers. Any numeral of 0 to F enters "*" in "RY *". Example: Device in the RY * × +6 field = RY6
1) ON/OFF states	Double-clicking the device you want to turn on/off reverses on/off. 1: ON 0: OFF
Buffer memory	Shows the buffer memory addresses of the master/local module corresponding to the RY.
Setting value	Shows the set values corresponding to the buffer memory addresses. You can change the set value by double-clicking it and setting a hexadecimal number.
"All clear" button	Used to erase all settings.
"Execute" button	Used to write the settings to the master/local module.
"Close" button	Used to close this screen.

POINT
Data are not written if they are merely set on the screen. Click the "Execute" button to write them to the master/local module.

7.8 Setting a Remote Station as Temporary Error Invalid Station (AJ61BT11, A1SJ61BT11 only)

(1) Purpose of operation

Set the specified remote station as a temporary error invalid station.

This enables the module to be changed without occurrence of a communication error.

POINT

Before performing this operation, start the data link of CC-Link.

(2) Operation procedure

Perform any of the following operations.

- Choose the [Online]—[Remote station exchanger support...] menu.
- Press the "Alt" + "X" keys.

(3) Setting screen

Preset the connection target.

Refer to Section 7.1 for the way to set the connection target.

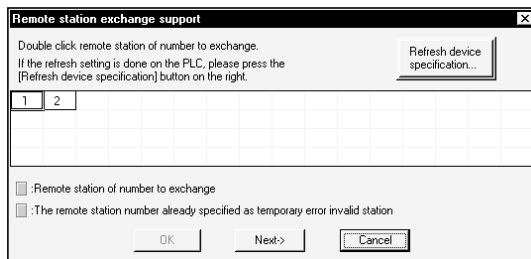

1. Double-click the station number of the module to be changed and click the "Next->" button.

Clicking the "Refresh device specification" button shows the "Refresh device specification" screen.

Refer to Section 7.7.2 (3)(a) for the operation method.



2. As the confirmation screen appears, click the "Yes" button.

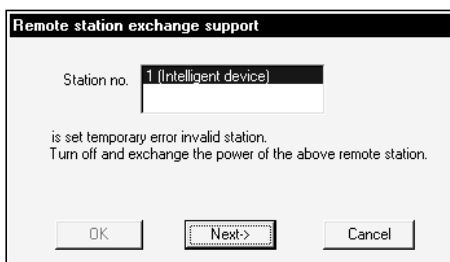

3. When the left screen has appeared, power off and change the module.

When the changing work is finished, click the "Next->" button.

(To the next page)

(From the preceding page)



4. When the left screen has appeared, power on the new module.
When it has powered on, click the "Next->" button.

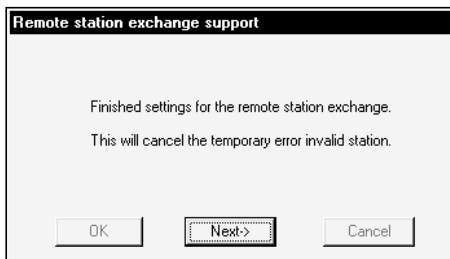

5. Read the on-screen information and click the "Next->" button.

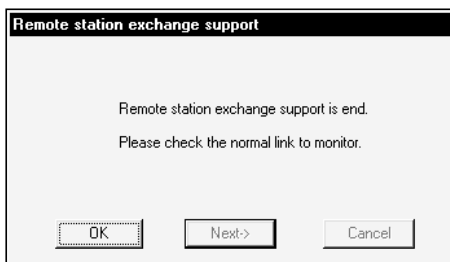

6. Click the "OK" button to finish the changing work.

! WARNING

- Follow the screen instructions when changing a module in remote station changing support operation.
Not doing so can cause the module to fail or malfunction.

7.9 Monitoring/Testing the Communication Status of CC-Link (When using AJ61QBT11, A1SJ61QBT11 or QJ61BT11)

POINT

Monitor/test can be used when the mode setting switch of the master/local module is in the online position.

7.9.1 Monitoring the host station

(1) Purpose of operation

Monitor the data link status and like of the host station (station where the peripheral device is connected).

(2) Operation procedure

Perform either of the following operations.

- Choose the [Online]-[Network monitor/Test...] menu.
- Press the "Alt" + "M" keys.

(3) Setting screen

Preset the connection target.

Refer to Section 7.1 for the way to set the connection target.

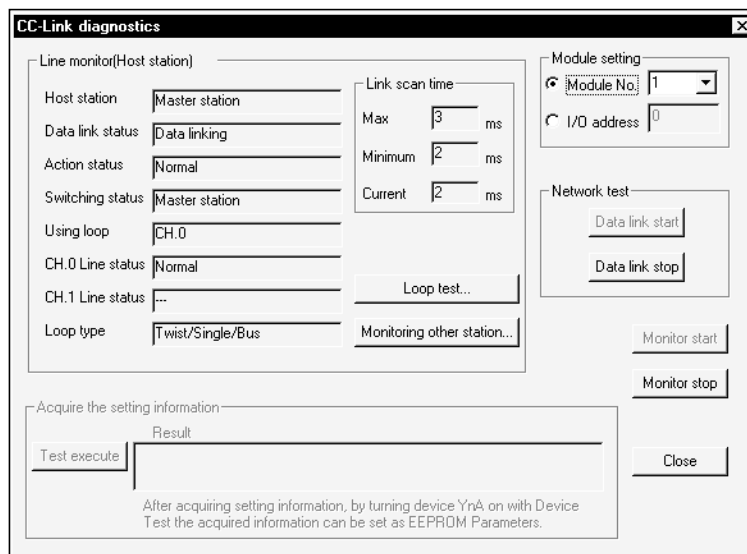

Item	Description
Module setting	Specify the target module of host station monitor in terms of " " or " ".
Network test	Used to start or stop the data link. This test cannot be used when the CC-Link master/local module is mounted on the MELSECNET/H remote I/O station.
"Data link start" button	Used to start host station monitor.
"Data link stop" button	Used to stop host station monitor.
Line monitor	—
Host station	Indicates that the station being monitored is any of the master, local and standby master stations. When the monitored station is the local station, its station number is also displayed.
Data link status	Shows the data link status of the host station.
Action status	Shows the operating status of the host station.
Switching status	Indicates which station controls the data link, the master station or standby master station.
Using loop	Shows the line in use.
Line status	Shows the line status.
Loop type	Shows the line type.
Link scan time	Displays the link scan time.
Loop test	Used to execute the line test. Refer to Section 7.9.3. This test cannot be used when the CC-Link master/local module is mounted on the MELSECNET/H remote I/O station.
Monitoring other station	Used to execute other station monitor. Refer to Section 7.9.2.
"Close" button	Used to close this screen.

7.9.2 Monitoring the other stations

(1) Purpose of operation

Monitor the data link statuses and like of the other stations (stations other than the one where the peripheral device is connected).

(2) Operation procedure

Perform either of the following operations.

- Choose the [Online]-[Network monitor/Test...] menu.
- Press the "Alt" + "M" keys.
Execute "Monitoring other station" on the host station monitor screen.

(3) Setting screen

Preset the connection target.

Refer to Section 7.1 for the way to set the connection target.

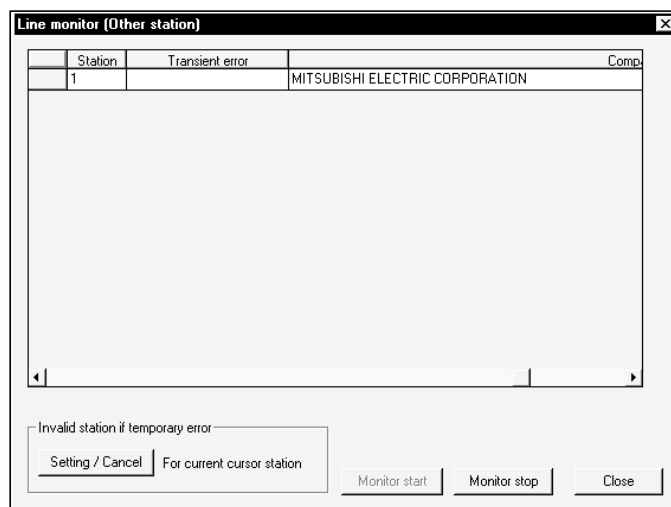
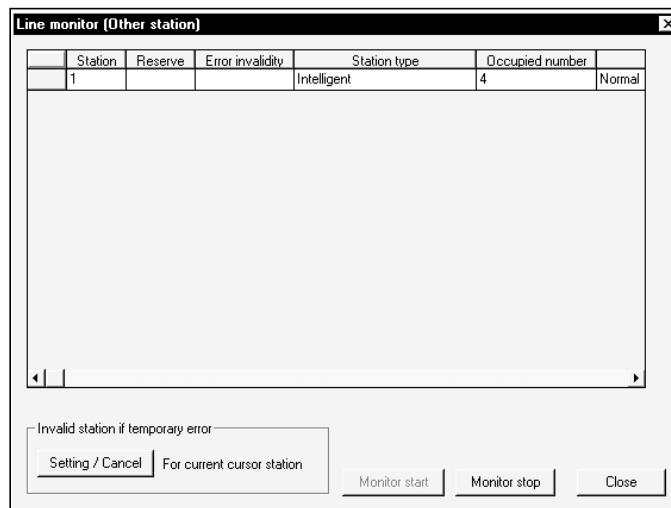

Item	Description
Station	Shows the first station number of each station.
Reserve	Indicates whether the reserved station setting has been made or not. "●" : Setting made " " : Setting not made
Error invalidity	Indicates whether the error-invalid station setting has been made or not. "●" : Setting made " " : Setting not made
Station type	Shows the station type. "Intelligent" : Local station, intelligent device station, standby master station "I/O" : Remote I/O station "Device" : Remote device station
Occupied number	Shows the number of occupied stations.
Status	Shows the data link status of the module.
Transient error	Indicates whether an error occurred or not during transient transmission. "●" : With error " " : Without error
Maker name	Shows the maker name. (Only the module whose maker name has been registered) Supported by only the QJ61BT11.
Invalid station if temporary error	Used to set or cancel the temporary error-invalid station. This setting cannot be used when the CC-Link master/local module is mounted on the MELSECNET/H remote I/O station.
"Monitor start" button	Used to start other station monitor.
"Monitor stop" button	Used to stop other station monitor.
"Close" button	Used to close this screen.

7.9.3 Conducting a line test

(1) Purpose of operation

Check the operating statuses of the stations connected.

This test cannot be used when the CC-Link master/local module is mounted on the MELSECNET/H remote I/O station.

(2) Operation procedure

Perform either of the following operations.

- Choose the [Online]-[Network monitor/Test...] menu.
- Press the "Alt" + "M" keys.
Execute "Loop test" on the host station monitor screen.

(3) Setting screen

Preset the connection target to the master station.

Refer to Section 7.1 for the way to set the connection target.

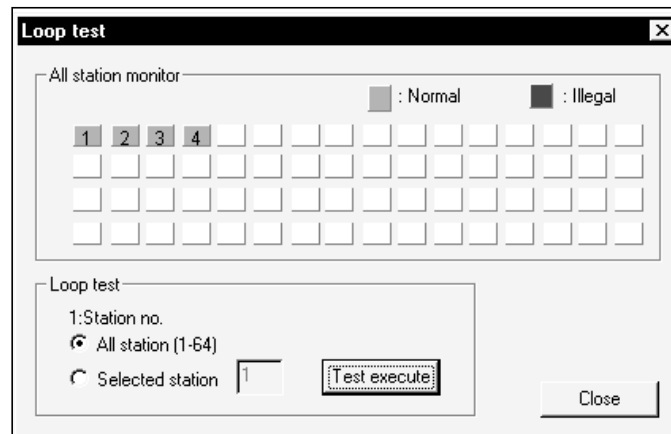

Item	Description
Loop test	—
Station no.	Specify the target station. All station : Specify when making a line test on all stations. Select station : Specify when making a line test on a specific station.
Test execute	Used to perform a line test on the station specified in .
All station monitor	Shows the result of the line test. A normal station is displayed "blue" and an abnormal station "red".
"Close" button	Used to close this screen.

7.10 Setting the R2 Buffer Memory (AJ61BT11, A1SJ61BT11 only)

POINTS
<p>(1) The setting operation to be performed after choosing the [Online]-[AJ65BT-R2 Utility] menu may be used when the following conditions are satisfied.</p> <ul style="list-style-type: none"> • Master station (Operation cannot be executed during control of the standby master station, either.) • PLC CPU is at STOP. • CC-Link data link has started. • Master station parameters have been set to secure 7 or more words for R2 send buffer and 4 or more words for receive buffer. <p>(2) When the RRPA instruction of the CC-Link-dedicated instructions is used, the operations in this section (AJ65BT-R2 utility) cannot be performed. If it is used, turn off the contact of the RRPA instruction and reset the PLC CPU once.</p>

7.10.1 Setting the R2 to be connected

- (1) Purpose of operation
Set the station number of the R2 to be connected and whether the automatic buffer memory update function is used or not.
- (2) Operation procedure
• Choose the [Online]—[AJ65BT-R2 Utility]—[Connect module set...] menu.
- (3) Setting screen
Preset the connection target.
Refer to Section 7.1 for the way to set the connection target.



Item	Description
Station number	Set the station number of the R2.
Buffer memory automatic update	Set "Use" when using the automatic buffer memory update function on the R2. Set "Not use" when the send/receive buffer is used.
"OK" button	Used to determine the settings and close this screen.
"Cancel" button	Used to discard the settings and close this screen.

POINT
<p>The Use/Not use setting of automatic buffer memory update depends on the mode setting switch position of the R2.</p> <p>Use: Mode setting switch = 1 Not use: Mode setting switch = 0</p>

7.10.2 Performing operation for the initial setting area

(1) Purpose of operation

You can access the initial setting area (0H to 19FH) of the R2 buffer memory, request the R2 to initialize, and register data to E²PROM.

(2) Operation procedure

- Choose the [Online]—[AJ65BT-R2 Utility]—[Operate initial setting area...] menu.

(3) Setting screen

Preset the connection target.

Refer to Section 7.1 for the way to set the connection target.

When the R2 to be connected is not specified, the R2 connection setting screen appears.

Refer to Section 7.10.1 for the way to set the R2 to be connected.

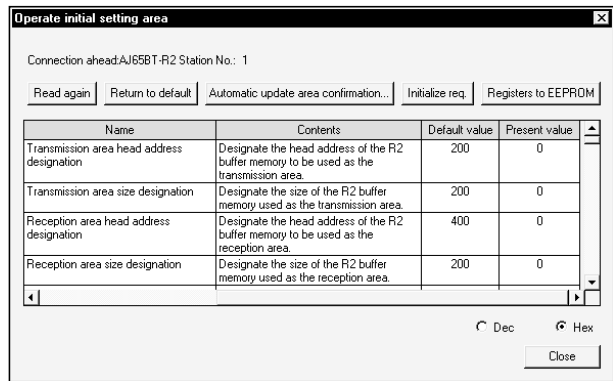
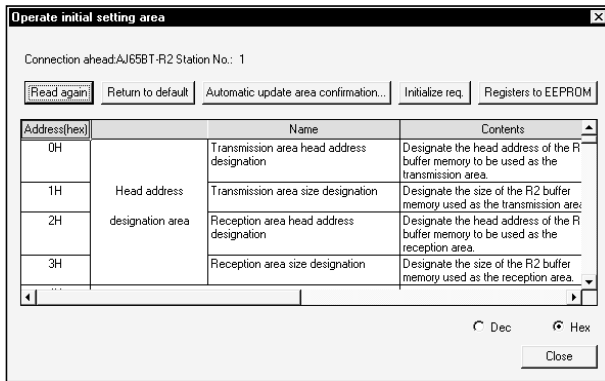

Item	Description
"Read again" button	Used to reread and update the present values of the R2 buffer memory (0H to 19FH).
"Returns to default" button	Used to return the present values to the initial values. Note that the present values on the GX Configurator-CC screen return to the initial values but the values set to E ² PROM do not return to the initial values. To return the values set to E ² PROM to the initial values, click this button, then click the "Registers to EEPROM" button to register the initial values to E ² PROM.

Item	Description																																								
<p>"Automatic update area confirmation" button</p>	<p>Used to open the following screen and list the settings of the areas used for automatic update.</p> <div data-bbox="571 398 1329 857" style="border: 1px solid black; padding: 5px;"> <p style="text-align: center; margin: 0;">Confirmation of buffer memory automatic update address ✕</p> <table border="1" style="width: 100%; border-collapse: collapse; text-align: center;"> <thead> <tr> <th style="width: 30%;">Transmission area</th> <th style="width: 20%;">R2 side head address</th> <th style="width: 20%;">Master station side offset address</th> <th style="width: 30%;">Transmission size</th> </tr> </thead> <tbody> <tr> <td>Status storage area</td> <td>1A0</td> <td>1A0</td> <td>20</td> </tr> <tr> <td>Transmission area 1</td> <td>118</td> <td>118</td> <td>88</td> </tr> <tr> <td>Transmission area 2</td> <td>200</td> <td>200</td> <td>200</td> </tr> <tr> <td>Reception area</td> <td>400</td> <td>400</td> <td>200</td> </tr> <tr> <td>Initial setting area</td> <td>0</td> <td>0</td> <td>1A0</td> </tr> <tr> <td>EEPROM function designation</td> <td>1C0</td> <td>1C0</td> <td>30</td> </tr> <tr> <td>User registration frame area</td> <td>1C7</td> <td>1C7</td> <td>29</td> </tr> <tr> <td>Monitor transmission area 1</td> <td>118</td> <td>118</td> <td>88</td> </tr> <tr> <td>Monitor transmission area 2</td> <td>200</td> <td>200</td> <td>200</td> </tr> </tbody> </table> <p style="text-align: right; margin-top: 10px;"><input type="button" value="Close"/></p> </div>	Transmission area	R2 side head address	Master station side offset address	Transmission size	Status storage area	1A0	1A0	20	Transmission area 1	118	118	88	Transmission area 2	200	200	200	Reception area	400	400	200	Initial setting area	0	0	1A0	EEPROM function designation	1C0	1C0	30	User registration frame area	1C7	1C7	29	Monitor transmission area 1	118	118	88	Monitor transmission area 2	200	200	200
Transmission area	R2 side head address	Master station side offset address	Transmission size																																						
Status storage area	1A0	1A0	20																																						
Transmission area 1	118	118	88																																						
Transmission area 2	200	200	200																																						
Reception area	400	400	200																																						
Initial setting area	0	0	1A0																																						
EEPROM function designation	1C0	1C0	30																																						
User registration frame area	1C7	1C7	29																																						
Monitor transmission area 1	118	118	88																																						
Monitor transmission area 2	200	200	200																																						
<p>"Initialize req." button</p>	<p>Used to write the present values to the R2 buffer memory and initialize the R2. As this button is used to set initialization to the R2 buffer memory, powering off the R2 returns the settings to the initial values. When you want to register the set present values as the R2's initial values, you need to click the "Registers to EEPROM" button to register the present values to E²PROM.</p>																																								
<p>"Registers to EEPROM" button</p>	<p>Used to register the set present values to E²PROM. Registering the values to E²PROM causes the registered values to be the R2's initial values.</p>																																								
<p>Address(hex)</p>	<p>Shows the R2's buffer memory addresses.</p>																																								
<p>Name</p>	<p>Shows the names of the R2's buffer memory addresses.</p>																																								
<p>Contents</p>	<p>Shows the definitions of the R2's buffer memory addresses.</p>																																								
<p>Default value</p>	<p>Shows the initial values of the R2's buffer memory.</p>																																								
<p>Present value</p>	<p>Shows the present values of the R2's buffer memory. Double-clicking enables the present value to be changed.</p>																																								
<p>Dec/Hex</p>	<p>Used to switch the present value display between decimal and hexadecimal.</p>																																								
<p>"Close" button</p>	<p>Used to close this screen.</p>																																								

7.10.3 Reading the setting status/communication status storage area

(1) Purpose of operation

Read the setting status storage area (1A0H to 1A7H) and communication status storage area (1A8H to 1BFH) of the R2 buffer memory.

(2) Operation procedure

- Choose the [Online]—[AJ65BT-R2 Utility]—[Read setting and communication status area...] menu.

(3) Setting screen

Preset the connection target.

Refer to Section 7.1 for the way to set the connection target.

When the R2 to be connected is not specified, the R2 connection setting screen appears.

Refer to Section 7.10.1 for the way to set the R2 to be connected.

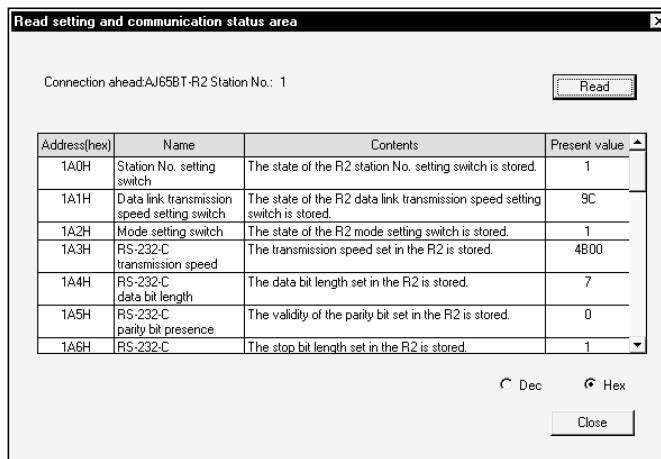

Item	Description
"Read" button	Used to read the setting status storage area (1A0H to 1A7H) and communication status storage area (1A8H to 1BFH) of the R2 buffer memory.
Address(hex)	Shows the R2's buffer memory addresses.
Name	Shows the names of the R2's buffer memory addresses.
Contents	Shows the definitions of the R2's buffer memory addresses.
Present value	Shows the present values of the R2's buffer memory.
Dec/Hex	Used to switch the present value display between decimal and hexadecimal.
"Close" button	Used to close this screen.

7.10.4 Reading the user free area

(1) Purpose of operation

Read the user free area (200H to 7FFH) of the R2 buffer memory.

(2) Operation procedure

- Choose the [Online]—[AJ65BT-R2 Utility]—[Read user free area...] menu.

(3) Setting screen

Preset the connection target.

Refer to Section 7.1 for the way to set the connection target.

When the R2 to be connected is not specified, the R2 connection setting screen appears.

Refer to Section 7.10.1 for the way to set the R2 to be connected.

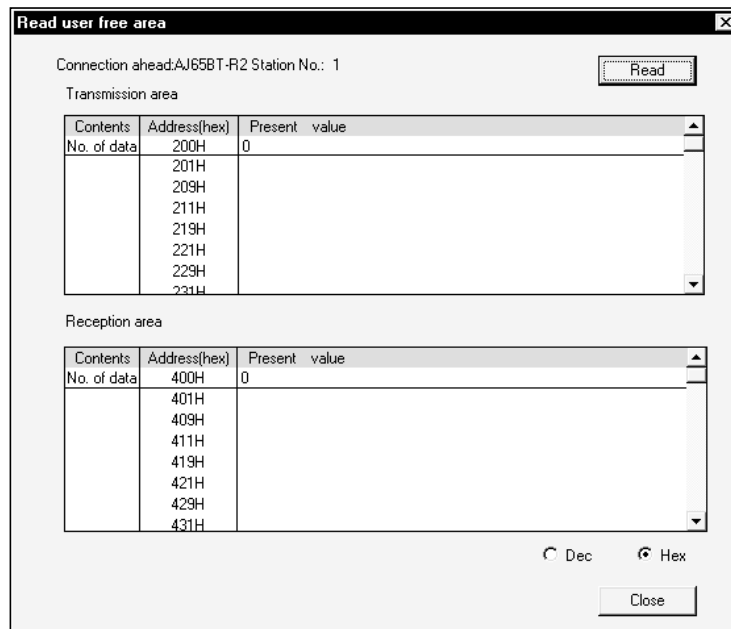

Item	Description
"Read" button	Used to read the user free area (200H to 7FFH) of the R2 buffer memory.
Contents	Shows the definitions of the R2's buffer memory addresses.
Address(hex)	Shows the R2's buffer memory addresses.
Present value	Shows the present values of the R2's buffer memory.
Dec/Hex	Used to switch the present value display between decimal and hexadecimal.
"Close" button	Used to close this screen.

7.10.5 Reading/registering/deleting the user registration frame

(1) Purpose of operation

Read, register or delete the user registration frame of the R2.

POINT
This operation turns on Yn0 (refresh directive) to communicate with the R2. Therefore, it may be output to other remote stations.

(2) Operation procedure

- Choose the [Online]—[AJ65BT-R2 Utility]—[Reading Register and Deleting user registration frame...] menu.

(3) Setting screen

Preset the connection target.

Refer to Section 7.1 for the way to set the connection target.

When the R2 to be connected is not specified, the R2 connection setting screen appears.

Refer to Section 7.10.1 for the way to set the R2 to be connected.

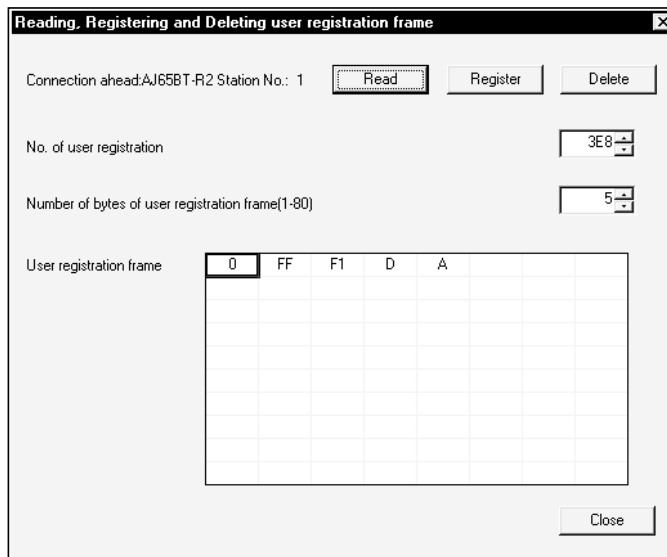

Item	Description
"Read" button	Used to read from E ² PROM of the R2 the frame of the number set to No. of user registration. The read result is displayed in Number of bytes of user registration frame and User registration frame.
"Register" button	Used to register to E ² PROM of the R2 the data of the number of bytes set to Number of bytes of user registration frame in the frame of the number set to No. of user registration. Enter the registered data into the User registration frame field. If you set the user registration frame that has more bytes than the specified number of bytes, only the specified bytes of the frame are registered.
"Delete" button	Used to delete from E ² PROM of the R2 the frame data of the number set to No. of registration.

Item	Description																																																								
No. of user registration (3E8H to 4AFH)	Set the user registration frame number within the range 3E8H to 4AFH.																																																								
Number of bytes of user registration frame	Set the number of user registration frame bytes within the range 1 to 80.																																																								
User registration frame	<p>For read, the data of the user registration frame are displayed. For write, set the data of the frame to be registered in hexadecimal. The data list is as shown below.</p> <table border="1" data-bbox="721 580 1176 831"> <tbody> <tr> <td>1</td><td>2</td><td>3</td><td>4</td><td>5</td><td>6</td><td>7</td><td>8</td> </tr> <tr> <td>9</td><td>10</td><td>11</td><td>12</td><td>13</td><td>14</td><td>15</td><td>16</td> </tr> <tr> <td></td><td></td><td></td><td></td><td>.</td><td></td><td></td><td></td> </tr> <tr> <td></td><td></td><td></td><td></td><td>.</td><td></td><td></td><td></td> </tr> <tr> <td></td><td></td><td></td><td></td><td>.</td><td></td><td></td><td></td> </tr> <tr> <td></td><td></td><td></td><td></td><td>.</td><td></td><td></td><td></td> </tr> <tr> <td>73</td><td>74</td><td>75</td><td>76</td><td>77</td><td>78</td><td>79</td><td>80</td> </tr> </tbody> </table>	1	2	3	4	5	6	7	8	9	10	11	12	13	14	15	16								73	74	75	76	77	78	79	80
1	2	3	4	5	6	7	8																																																		
9	10	11	12	13	14	15	16																																																		
				.																																																					
				.																																																					
				.																																																					
				.																																																					
73	74	75	76	77	78	79	80																																																		
"Close" button	Used to close this screen.																																																								

7.10.6 Monitoring the I/O data (RX, RY)

- (1) Purpose of operation
You can monitor the I/O data (RX, RY) of the R2.
- (2) Operation procedure
 - Choose the [Online]—[AJ65BT-R2 Utility]—[I/O information monitor...] menu.
- (3) Setting screen
Preset the connection target.
Refer to Section 7.1 for the way to set the connection target.
When the R2 to be connected is not specified, the R2 connection setting screen appears.
Refer to Section 7.10.1 for the way to set the R2 to be connected.

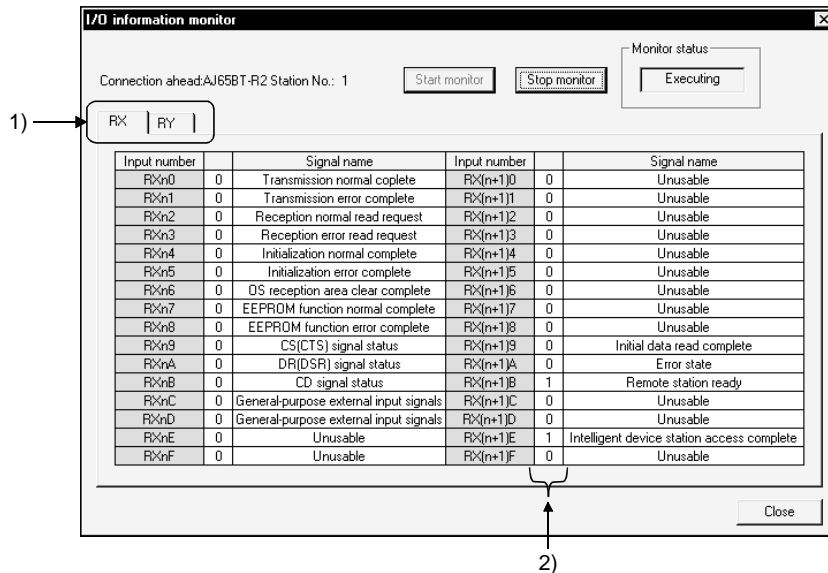

Item	Description
"Start monitor" button	Used to start monitor.
"Stop monitor" button	Used to stop monitor.
Monitor status	Shows the present monitor status.
1) Tabs	Clicking changes the monitored devices.
Input/Output number	Shows the RX or RY numbers.
2) ON/OFF states	Shows the ON/OFF states of the monitored devices. 1 : ON 0 : OFF
Signal name	Shows the signal names of RX or RY.
"Close" button	Used to close this screen.

8 OTHER OPERATIONS

8.1 Setting the Master Parameters Automatically (Master Parameter Creation Wizard) (AJ61BT11, A1SJ61BT11 only)

(1) Purpose of operation

The modules connected to CC-Link are automatically recognized to create the master parameters.

POINT
<p>Before starting the operation in this section, perform the following operations.</p> <p>(1) Set the PLC CPU to STOP.</p> <p>(2) Power on all connected remote stations.</p> <p>(3) Since data is not read from the station set as the standby master station, set the standby master station as a local station.</p>

(2) Operation procedure

Perform either of the following operations.

- Choose the [File]—[Master parameter create Wizard...] menu.
- Press the "Ctrl" + "W" keys.

(3) Setting screen

Preset the connection target.

Refer to Section 7.1 for the way to set the connection target.



1. Read the information and click the "OK" button.



2. Since data cannot be read from the station which was set as the standby master station, set it as a local station. After setting, click the "OK" button.

(To the next page)

(From the preceding page)

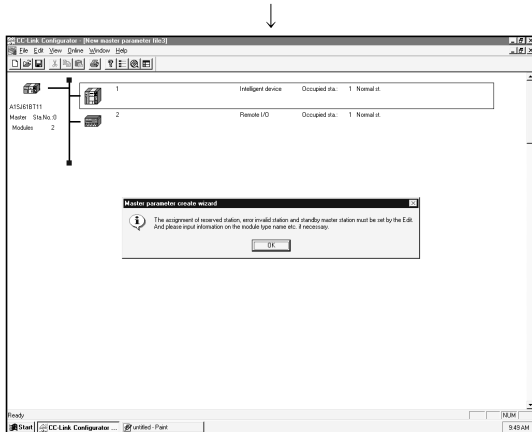

3. Clicking the "OK" button completes this setting. To specify the reserved, error invalid and standby master stations, perform editing on GX Configurator-CC. Also enter such information as the module type on GX Configurator-CC.

8.2 Registering/Deleting the Remote Station Type

- (1) Purpose of operation
 Register or delete to or from GX Configurator-CC the information specific to the station corresponding to the type of the remote station as a CSP file.
 You can add newly purchased remote stations to the list.
- (2) Operation procedure
 Perform either of the following operations.
 - Choose the [File]—[Registers remote station type...] menu.
 - Press the "Alt" + "N" keys.
- (3) Setting screen

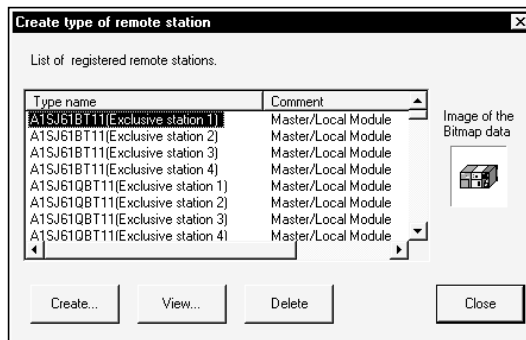

Item	Description
Type	Shows the types currently registered to GX Configurator-CC.
Comment	Show the comments for the modules.
Display bitmap	Shows the bitmap displayed when the type is used on GX Configurator-CC.
"Create..." button	<p>Used to display the following screen.</p> <p>Click when registering the already created CSP file as a new remote station. As clicking opens the screen, open the CSP file to be imported.</p>  <p>Click when registering a new remote I/O station. Clicking opens the screen. Refer to (a) "Registers remote station type..."</p>

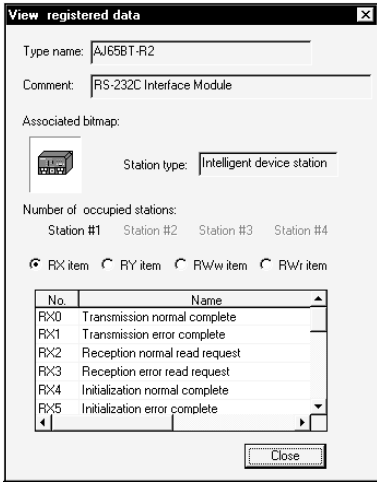
Item	Description
"View..." button	Used to show the contents of RX, RY, RWw or RWr of the selected remote station. 
"Delete" button	Used to delete the selected remote station type.
"Close" button	Used to close this screen.

(a) "Register remote station type" screen

Used to set the information on the remote I/O station to be registered newly.

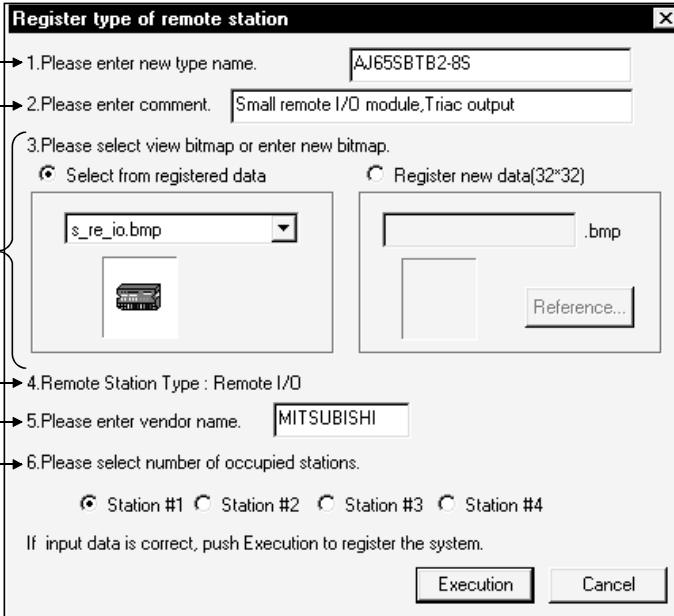

1) Please enter new type name.

2) Please enter comment.

3) Please select view bitmap or enter new bitmap.
 Select from registered data Register new data(32*32)
 .bmp

4) Remote Station Type : Remote I/O

5) Please enter vendor name.

6) Please select number of occupied stations.
 Station #1 Station #2 Station #3 Station #4

If input data is correct, push Execution to register the system.

Item	Description
1) Newly registered type	Set the type of the new remote I/O station to be registered.
2) Comment	Set the comment for the new remote I/O station to be registered.
3) Display bitmap	Set the bitmap displayed when a remote station is added to the master parameters, for example. When you choose "Select from registered data", any bitmap is selected from among the bitmaps registered to GX Configurator-CC. When you choose "Register new data", you can click the "Browse" button to browse the bitmaps in any folder.
4) Remote station type	Fixed to the remote I/O station.
5) Maker name	Set the maker name of the new remote I/O station to be registered.
6) Number of stations occupied	Set the number of stations occupied by the new remote I/O station to be registered.
"Execution" button	Used to register the new remote I/O station with the set data.
"Cancel" button	Used to discard the settings and close this screen.

8.3 Printing (AJ61BT11, A1SJ61BT11 only)

- (1) Purpose of operation
Print the master parameter settings or I/O refresh address table.
- (2) Operation procedure
Perform any of the following operations.
 - Choose the [File]—[Print/Print preview...] menu.
 - Click .
 - Press the "Ctrl" + "P" keys.
- (3) Setting screen

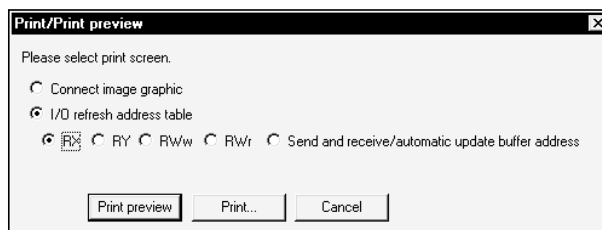

Item	Description
Connect image graphic	Choose when printing the connection image chart (master parameter edit screen).
I/O refresh address table	Choose when printing the data displayed on the I/O refresh address table screen in Section 8.6. Choose the item you want to print (RX, RY, RWw, RWr, send/receive/automatic update buffer addresses).
"Print preview" button	Used to display the print preview screen.
"Print" button	Used to perform printing.
"Cancel" button	Used to close this screen.

POINTS
(1) When making paper setting for printing, set the paper size to A4 and the print orientation to portrait in Printer setup.
(2) If postscript-printer is used, the used font might not be suitable for the printer. In this case, it may not be able to print correctly.

(4) Printing examples
 (a) Connection image chart

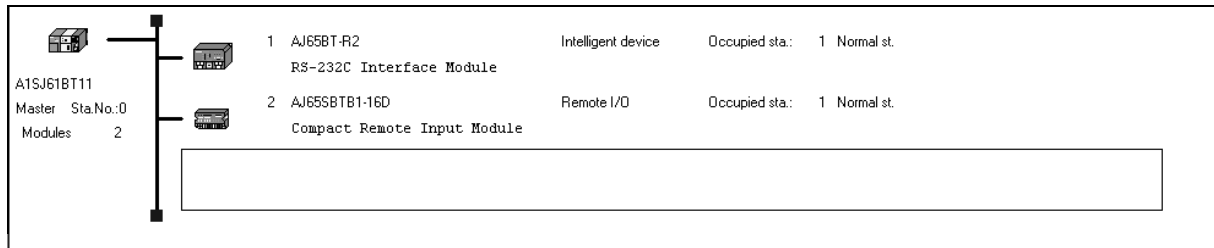

(b) I/O refresh address tables
 1) RX

I/O refresh address table RX
 New master parameter file1
 Master A1SJ61BT11

	Sta No.	Type name	Type	Normal st. Reserved st. Err.invalid st.	Standby Master	Comment
RX0-RXF (E0H)	1	AJ65BT-R2	Intelligent device	Normal st.		RS-232C Interface Module
RX10-RX1F (E1H)						
RX20-RX2F (E2H)	2	AJ65SBTB1-16D	Remote I/O	Normal st.		Compact Remote Input Module
RX30-RX3F (E3H)						
RX40-RX4F (E4H)						
RX50-RX5F (E5H)						
RX60-RX6F (E6H)						
RX70-RX7F (E7H)						
RX80-RX8F (E8H)						
RX90-RX9F (E9H)						
RXA0-RXAF (EAH)						
RXB0-RXBF (EBH)						
RXC0-RXCF (ECH)						

2) RY

I/O refresh address table RY
 New master parameter file1
 Master A1SJ61BT11

	Sta No.	Type name	Type	Normal st. Reserved st. Err.invalid st.	Standby Master	Comment
RY0-RYF (160H)	1	AJ65BT-R2	Intelligent device	Normal st.		RS-232C Interface Module
RY10-RY1F (161H)						
RY20-RY2F (162H)	2	AJ65SBTB1-16D	Remote I/O	Normal st.		Compact Remote Input Module
RY30-RY3F (163H)						
RY40-RY4F (164H)						
RY50-RY5F (165H)						
RY60-RY6F (166H)						
RY70-RY7F (167H)						
RY80-RY8F (168H)						
RY90-RY9F (169H)						
RYA0-RYAF (16AH)						
RYB0-RYBF (16BH)						
RYC0-RYCF (16CH)						

3) RWw

I/O refresh address table RWw
 New master parameter file1
 Master A1SJ61BT11

	Sta No.	Type name	Type	Normal st. Reserved st. Err.invalid st.	Standby Master	Comment
RWw0(1E0H)	1	AJ65BT-R2	Intelligent device	Normal st.		RS-232C Interface Module
RWw1(1E1H)						
RWw2(1E2H)						
RWw3(1E3H)						
RWw4(1E4H)	2	Not used(RemoteI/O)				
RWw5(1E5H)						
RWw6(1E6H)						
RWw7(1E7H)						
RWw8(1E8H)						
RWw9(1E9H)						
RWwA(1EAH)						
RWwB(1EBH)						
RWwC(1ECH)						

4) RWr

I/O refresh address table RWr
 New master parameter file1
 Master A1SJ61BT11

	Sta No.	Type name	Type	Normal st. Reserved st. Err.invalid st.	Standby Master	Comment
RWr0(2E0H)	1	AJ65BT-R2	Intelligent device	Normal st.		RS-232C Interface Module
RWr1(2E1H)						
RWr2(2E2H)						
RWr3(2E3H)						
RWr4(2E4H)	2	Not used(RemoteI/O)				
RWr5(2E5H)						
RWr6(2E6H)						
RWr7(2E7H)						
RWr8(2E8H)						
RWr9(2E9H)						
RWrA(2EAH)						
RWrB(2EBH)						
RWrC(2ECH)						

5) Send/receive/automatic update buffer addresses

I/O refresh address table Send and receive / automatic update buffer address
 New master parameter file1
 Master A1SJ61BT11

StaNo.	Type of intelligent device	Send Buffer Address (Bank1)	Receive Buffer Address (Bank1)	Automatic update Buffer Address (Bank2)
1	AJ65BT-R2	0H -- 3FH	40H -- 7FH	0H -- 5FFH

8.4 Setting the Printer (AJ61BT11, A1SJ61BT11 only)

- (1) Purpose of operation
Set the printer used for printing.
- (2) Operation procedure
Perform either of the following operations.
 - Choose the [File]—[Printer_setup...] menu.
 - Press the "Alt" + "P" keys.
- (3) Setting screen

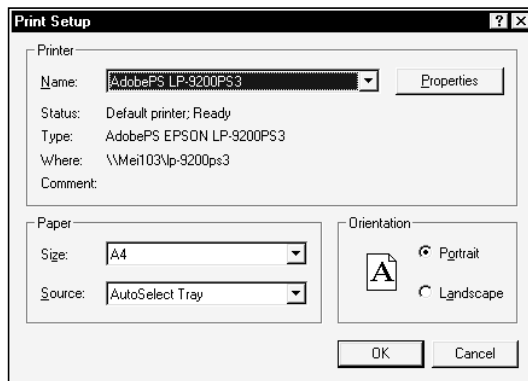

Item	Description
Name	Choose the printer for printing.
"Properties" button	Clicking this button shows the printer properties screen. On printer properties, make the basic settings of the printer.
Size	Set the paper size to be used. Specify "A4" when printing on GX Configurator-CC.
Source	Set the paper feed mode of the printer.
Orientation	Set whether a document is printed across the narrower (portrait) or wider (landscape) dimension of a rectangular sheet of paper. Specify "Portrait" when printing on GX Configurator-CC.
"OK" button	Used to determine the settings and close this screen.
"Cancel" button	Used to discard the settings and close this screen.

8.5 Setting Whether the Toolbar and/or Status Bar Is Displayed or Hidden

- (1) Purpose of operation
Set whether the toolbar and/or status bar is displayed or hidden.
- (2) Operation procedure
 - Choose the [View]—[Tool bar.../status bar] menu.
- (3) Explanation
When the menu item has a check mark ✓ on its left, the corresponding bar is displayed.
When the menu item does not a check mark ✓, the corresponding bar is not displayed.

8.6 Listing the Refresh Addresses of RX, RY or Others (AJ61BT11, A1SJ61BT11 only)

- (1) Purpose of operation
Display the RX, RY, RWw, RWr, send/receive buffer or automatic update buffer addresses in a list.
- (2) Operation procedure
Perform any of the following operations.
 - Choose the [File]—[I/O refresh address table...] menu.
 - Click .
 - Press the "Alt" + "I" keys.
- (3) Setting screen

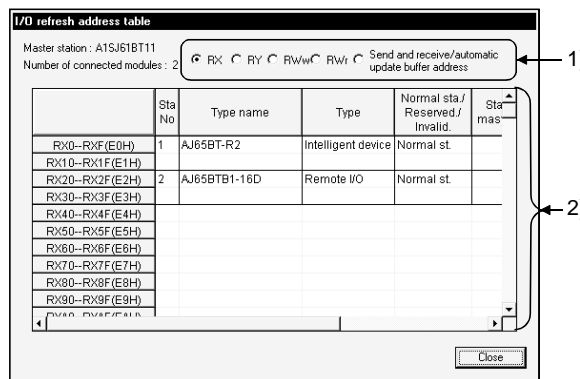

Item	Description
Master	Shows the type of the master module.
Number of connected modules	Shows the number of connected remote stations.
1) Displayed table	Click the radio button of the item you want to display.
2) Data display screen	Shows the data of the item selected in 1).
"Close" button	Used to close this screen.

Microsoft Windows, Windows NT are registered trademarks of Microsoft Corporation in the United States and other countries.

Pentium is a registered trademark of Intel Corporation in the United States and other countries.

Other company and product names herein are either trademarks or registered trademarks of their respective owners.

SPREAD

Copyright (C) 1998 Farpoin Technologies, Inc.

GX Configurator-CC Version 1

Operating Manual

MODEL	SW0D5C-J61P-E-O
MODEL CODE	13JU05
SH(NA)-080103-D(0302)MEE	

 **MITSUBISHI ELECTRIC CORPORATION**

HEAD OFFICE : 1-8-12, OFFICE TOWER Z 14F HARUMI CHUO-KU 104-6212, JAPAN
NAGOYA WORKS : 1-14 , YADA-MINAMI 5 , HIGASHI-KU, NAGOYA , JAPAN

When exported from Japan, this manual does not require application to the Ministry of Economy, Trade and Industry for service transaction permission.

Specifications subject to change without notice.