

MITSUBISHI

A1SD59J-S2/MIF Memory Card Interface Module

User's Manual

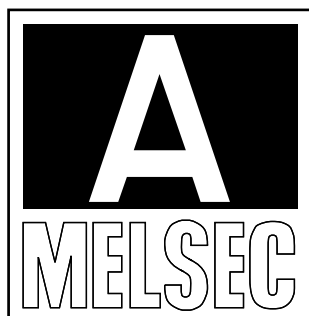
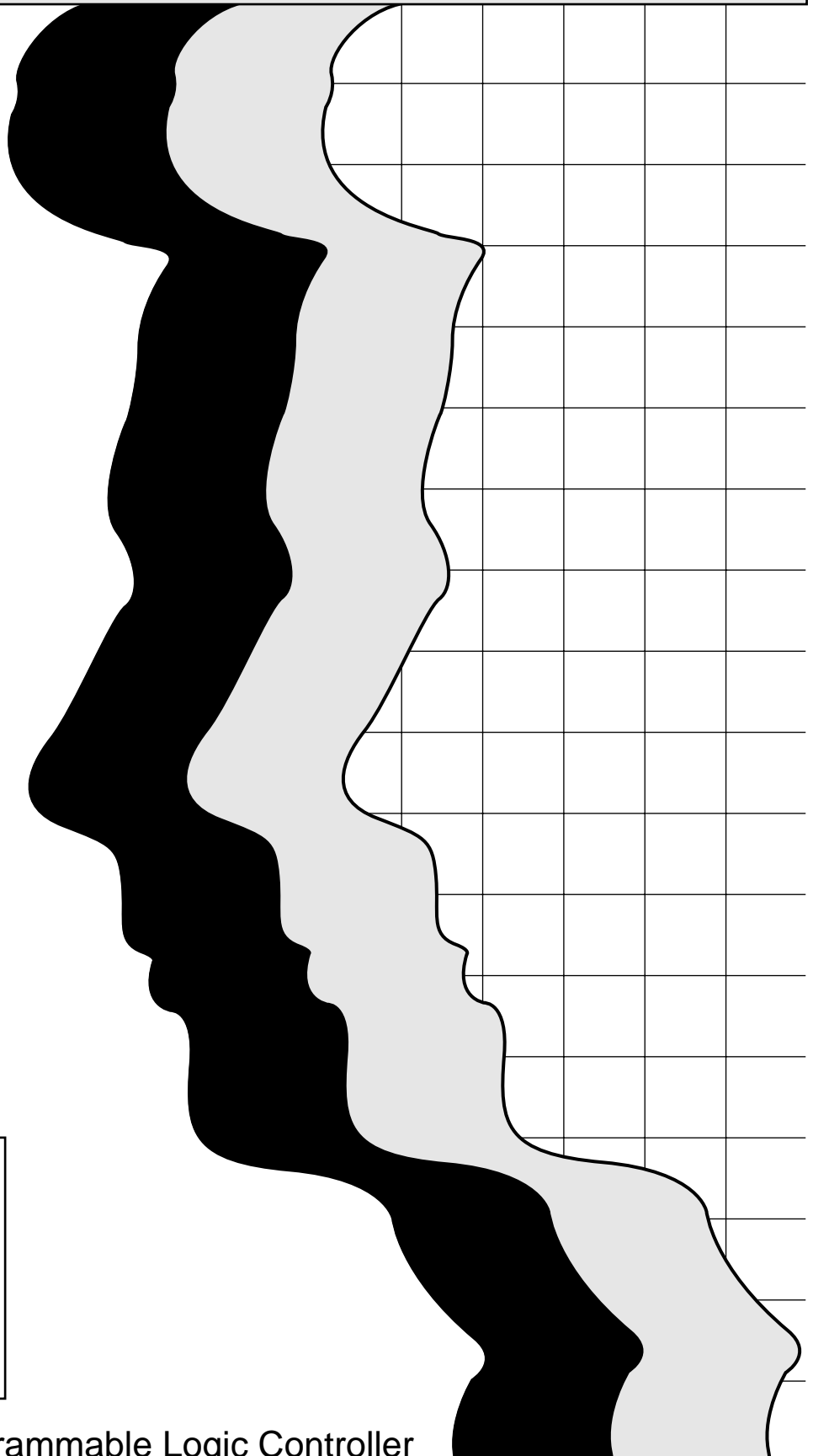

Mitsubishi Programmable Logic Controller

• SAFETY PRECAUTIONS •

(Read these precautions before using.)

When using this equipment, thoroughly read this manual. Also pay careful attention to safety and handle the module properly.

These precautions apply only to this equipment.

Refer to the CPU module User's Manual for a description of the PC system safety precautions.

These • Safety Precautions • classify the safety precautions into two categories: "DANGER" and "CAUTION".



DANGER

Procedures which may lead to a dangerous condition and cause death or serious injury if not carried out properly.



CAUTION

Procedures which may lead to a dangerous condition and cause superficial to medium injury, or physical damage only, if not carried out properly.

Depending on circumstances, procedures indicated by CAUTION may also be linked to serious results. In any case, it is important to follow the directions for usage.

Store this manual in a safe place so that you can take it out and read it whenever necessary. Always make it available to the end user.

[Design Precautions]

CAUTION

- Do not have control cables and communication cables bundled with or placed near by the main circuit and/or power cables.
Wire those cables at least 100mm (3.94 inch) away from the main circuit and/or power cables. Otherwise, it may cause malfunction due to noise interference.

[Installation Precautions]

CAUTION

- Use each PC and memory card module in an environment as specified in the "general specification" in the manual.
Usage of the module outside the general specification range may cause electric shock, fire, malfunction, product damage or deterioration.
- Correctly connect the connection cable to each connector of the module.
A poor connection could result in wrong input or erroneous operation.
- Install the memory card securely into the memory card installation connector.
After the installation, check the memory card for alignment with the connector.
A poor connection could result in erroneous operation.

[Installation Precautions]

CAUTION

- Before installation, ensure to insert the module fixing projections located on the underside of the module into the fixing holes in the base.
Failure to do so may cause malfunction, trouble or the module to fall.
- Do not directly touch the module's conductive parts.
Doing so could cause malfunction or trouble in the module.

[Wiring Precautions]

DANGER

- Perform installation and wiring after disconnecting the power supply at all phases externally.
If the power is not disconnected at all phases an electric shock or product damage may result.

CAUTION

- Do not connect cables to the module with the module installed station powered ON.
- Make sure foreign objects do not get inside the module, such as dirt and wire chips.
It may cause fire, trouble or malfunction.

[Starting and Maintenance Precautions]

DANGER

- Switch all phases of the external power supply off when cleaning the module or retightening the terminal or module mounting screws. Not doing so could result in electric shock.
Undertightening of terminal screws can cause a short circuit or malfunction. Overtightening of screws can cause damages to the screws and/or the module, resulting in fallout, short circuits, or malfunction.

CAUTION

- Never try to disassemble or modify the module.
It may cause trouble, malfunction, injury or fire.
- Switch all phases of the external power supply off before mounting or removing the module.
If you do not switch off the external power supply, it will cause failure or malfunction of the module.
- Always make sure to touch the grounded metal to discharge the electricity charged in the electricity charged in the body, etc., before touching the module.
Failure to do so may cause a failure or malfunctions of the module.

[Disposal Precautions]

 **CAUTION**

- When disposing of this product, treat it as industrial waste.

[TRANSPORTATION PRECAUTIONS]

 **CAUTION**

- When transporting lithium batteries, make sure to treat them based on the transport regulations.
(Refer to Appendix 2 for details of the controlled models.)

REVISIONS

* The manual number is given on the bottom left of the back cover.

| Print Date | * Manual Number | Revision |
|------------|------------------|---|
| Nov., 1999 | SH (NA) 080056-A | First edition |
| Dec., 2003 | SH (NA) 080056-B | <p data-bbox="598 387 767 421">Addition</p> <p data-bbox="598 439 1011 472">Appendix 2, 2.1, 2.2, WARRANTY</p> <p data-bbox="598 483 869 517">Partial Addition</p> <p data-bbox="598 528 735 562">Section 5.1</p> <p data-bbox="598 573 869 607">Partial Correction</p> <p data-bbox="598 618 1209 651">SAFETY PRECAUTIONS, Section 2.1, 2.2, 2.3, 4.3</p> <p data-bbox="598 663 839 696">Partial Deletion</p> <p data-bbox="598 707 839 741">Section 2.3, 3.1, 4.4</p> |
| | | |

Japanese Manual Version SH-3613-C

This manual confers no industrial property rights or any rights of any other kind, nor does it confer any patent licenses. Mitsubishi Electric Corporation cannot be held responsible for any problems involving industrial property rights which may occur as a result of using the contents noted in this manual.

© 1999 MITSUBISHI ELECTRIC CORPORATION

INTRODUCTION

Thank you for purchasing the Mitsubishi general-purpose programmable logic controller MELSEC-A series. Before using the equipment, please read this manual carefully to develop full familiarity with the functions and performance of the programmable logic controller A series you have purchased, so as to ensure correct use. Please make this manual available to the end user.

CONTENTS

| | |
|---|---------------------|
| Safety Precautions | A- 1 |
| Revisions | A- 4 |
| Contents..... | A- 5 |
| About the Manuals..... | A- 7 |
| 1 OVERVIEW | 1- 1 |
| 1.1 Futures..... | 1- 1 |
| 2 SYSTEM CONFIGURATION | 2- 1 to 2- 4 |
| 2.1 System Configuration | 2- 1 |
| 2.2 Applicable System..... | 2- 2 |
| 2.3 Memory Card..... | 2- 2 |
| 2.4 Difference between AD59 (S1) and A1SD59J Modules and Cautions on Diversion of Programs from AD59 (S1) Module | 2- 3 |
| 3 SPECIFICATIONS | 3- 1 to 3- 6 |
| 3.1 Performance Specifications | 3- 1 |
| 3.2 Buffer Memory..... | 3- 2 |
| 3.3 I/O Signals | 3- 3 |
| 4 SETTINGS AND PROCEDURES UP TO OPERATION | 4- 1 to 4- 6 |
| 4.1 Procedures up to Operation..... | 4- 1 |
| 4.2 Cautions on Handling..... | 4- 2 |
| 4.3 Names of the Parts..... | 4- 3 |
| 4.4 Push-button Switch (Input Signals (X1, X2) entered by Push-buttons Front Surface of Module)..... | 4- 4 |
| 4.5 Setting Environment..... | 4- 5 |
| 4.6 Installation Method | 4- 5 |
| 5 PROGRAMMING | 5- 1 to 5- 2 |
| 5.1 Programming for Memory Card Control | 5- 1 |
| 5.1.1 Example of application of memory card | 5- 2 |
| 6 MAINTENANCE | 6- 1 to 6- 2 |
| 6.1 Storage of Module | 6- 1 |
| 6.2 Replacing Battery | 6- 2 |

| | |
|--|------|
| 6.2.1 Battery replacement time | 6- 2 |
| 6.2.2 Battery replacement procedure..... | 6- 2 |

| | |
|--------------------------|---------------------|
| 7 TROUBLESHOOTING | 7- 1 to 7- 2 |
|--------------------------|---------------------|

| | |
|---|------|
| 7.1 Flowchart when the Memory Card cannot be accessed normally..... | 7- 1 |
|---|------|

| | |
|-----------------|-------------------------|
| APPENDIX | App- 1 to App- 3 |
|-----------------|-------------------------|

| | |
|---|--------|
| Appendix-1 External Dimensions Diagram..... | App- 1 |
| Appendix-2 Transportation Precautions | App- 3 |
| Appendix-2.1 Controlled Models | App- 3 |
| Appendix-2.2 Transport Guidelines..... | App- 3 |

About the Manuals

The following manuals are related to the A1SD59J-S2/MIF memory card interface module.

Related Manuals

| Manual Name | Manual Number (Model Code) |
|--|-------------------------------|
| A1SD59J-S2 Memory Card Interface Module User's Manual (Hardware version) This manual describes the performance specifications, names of parts, settings and procedures for operation of the A1SD59J-S2 memory card interface module. | IB-68785 (13JH94) |
| A1SD59J-MIF Memory Card Module User's Manual (Hardware version) This manual describes the performance specifications, names of parts, settings and procedures for operation of the A1SD59J-MIF memory card module. | IB-68786 (13JH95) |

1 Overview

1

This User's manual includes specifications, handling information and programming method of the A1SD59J-S2 memory card interface module and A1SD59J-MIF memory card module (hereinafter referred to as the "A1SD59J").

The A1SD59J module allows a memory card of JEIDA Ver. 4 to gain access to it. No printer interface is provided in the module.

1.1 Features

This module can store data collected by the sequencer CPU in the memory card, and also temporarily store the data as the external auxiliary register of the sequencer. Depending on the memory card to be used, the module allows the memory card of 2MB max. to gain access to it.

Multiple memory cards enable high-volume data to be stored (data bank) and, by the replacement of the memory card, any data can be loaded up easily to the sequencer CPU.

The memory card read or written in the A1SD59J module cannot read or edit data because it is not compatible with the other peripheral equipment.

Memory Card Interface Connection

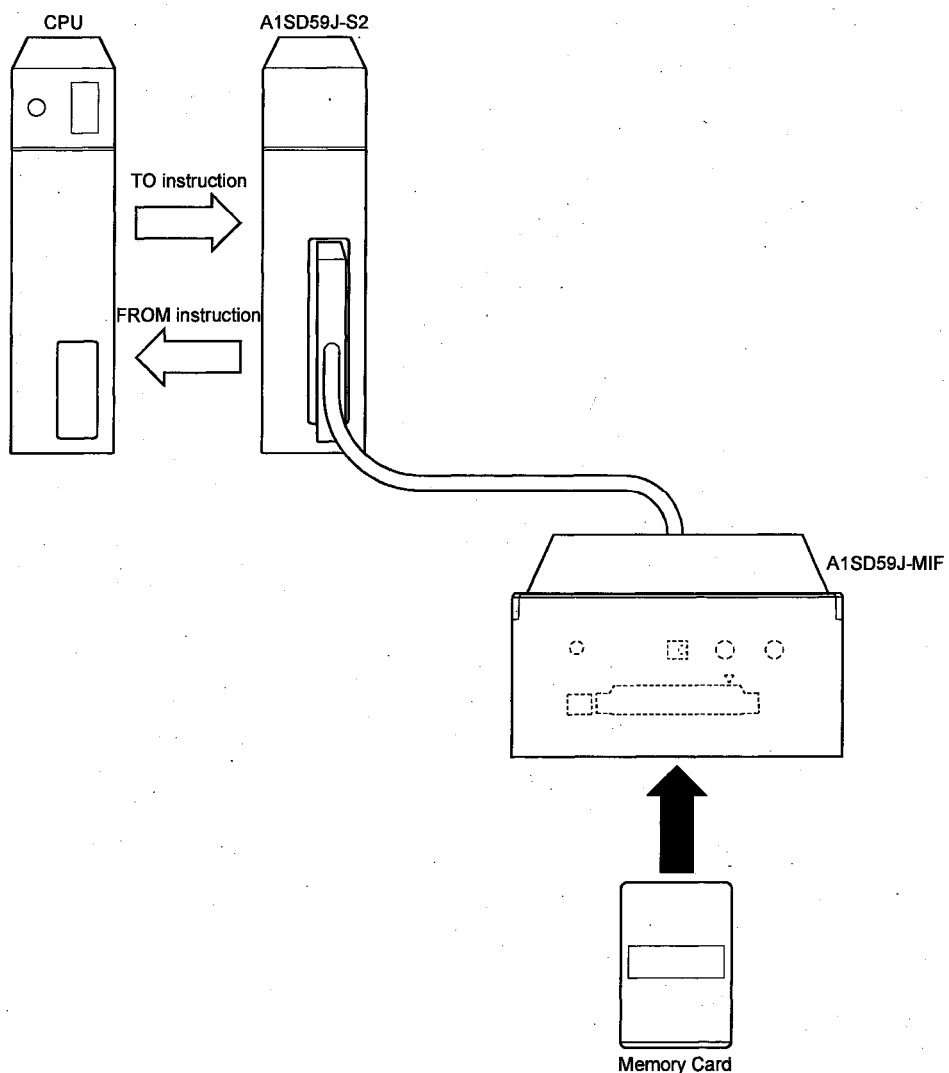

MEMO

2 System Configuration

This section describes the system configuration which combines the A1SD59J-S2 and A1SD59J-MIF modules.

2.1 System Configuration

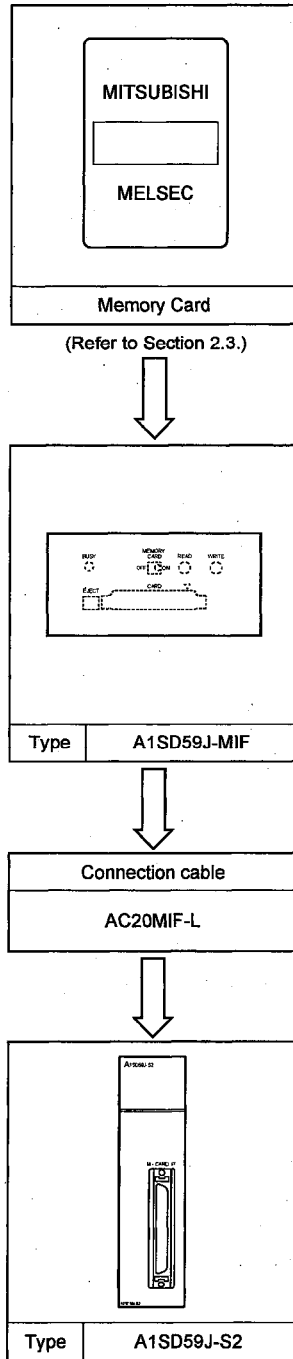

REMARK

Refer to Section 2.2 for the applicable CPU modules and base units.

2.2 Applicable System

The A1SD59J module can be used in the systems specified below.

(1) Applicable CPU modules and No. of mountable modules

| CPU Type | No. of modules installed |
|-----------------|--------------------------|
| A1SJ (H) CPU | Limitless |
| A1S (H) CPU | |
| A2S (H) CPU | |
| A2ASCPU (S1) | |
| A2ASCPU-S30 | |
| A2ASCPU-S60 | |
| A2USHCPU-S1 | |
| Q2AS (H) CPU | |
| Q2AS (H) CPU-S1 | |
| Q02 (H) CPU-A | |
| Q06HCPU-A | |
| Q02 (H) CPU | |
| Q06HCPU | |
| Q12HCPU | |
| Q25HCPU | |

(2) Mountable base modules

The A1SD59J module can be installed into any I/O slot of the base modules except for the module specified below.

- (a) If the A1SD59J module is installed on the extension base module without the power supply module, the power capacity may be reduced. To prevent this problem, avoid installing it on this module as far as practicable. If it must be installed and used on the extension base module, carefully consider the current capacity of the main base module and the voltage drop of the extension cables in selecting an appropriate power supply module and extension cables.

(For details, refer to the User's Manual of the applicable CPU module (See Section (1)).)

- (b) The module cannot be installed directly on the Q35B, Q38B or Q312B. Use the QA1S65B or QA1S68B for installation.

2.3 Memory Card

The allowable memory cards for the A1SD59J module are as listed below.

| Item Name | Model | Description | Remark |
|-----------------------------|------------|--|--------|
| Memory card of JEIDA Ver. 4 | Q1MEM-64S | For the QnACPU, Memory capacity 64k byte (SRAM) | |
| | Q1MEM-128S | For the QnACPU, Memory capacity 128k byte (SRAM) | |
| | Q1MEM-256S | For the QnACPU, Memory capacity 256k byte (SRAM) | |
| | Q1MEM-512S | For the QnACPU, Memory capacity 512k byte (SRAM) | |
| | Q1MEM-1MS | For the QnACPU, Memory capacity 1M byte (SRAM) | |
| | Q1MEM-2MS | For the QnACPU, Memory capacity 2M byte (SRAM) | |

2.4 Difference between AD59 (S1) and A1SD59J Modules and Cautions on Diversion of Programs from AD59 (S1) Module

- (1) Some differences between AD59 (S1) and A1SD59J modules are as shown below.

| Item | AD59 (S1) | A1SD59J |
|--|---|-----------------------|
| Number of processable banks | 4 banks | 256 banks* |
| Max. capacity capable of being accessed to memory card | 32KB | 2MB* |
| Interface | Parallel interface Memory card interface | Memory card interface |

*..... Depends on the memory card to be used.

- (2) Cautions on diversion of programs from AD59 (S1) module
 You cannot use the AD59 (S1) dedicated instructions incorporated in the AnACPU, AnUCPU and QnACPU. When diverting them to those for the A1SD59J module, modify the dedicated instructions.

3 Specifications

This section describes the performance specifications, I/O signals and buffer memories of the A1SD59J module.

For the general specifications of the A1SD59J module, refer to the User's Manual of the applicable CPU module (Hardware version).

3.1 Performance Specifications

- (1) The following table lists the performance specifications of the A1SD59J-S2.

| Item | Performance specifications |
|-------------------------------|-------------------------------|
| Number of I/O occupied points | 32 points |
| Number of channels | 1 channel |
| Internal current consumption | 50mA (including A1SD59J-MIF) |
| Weight | 0.2Kg |
| External Dimensions | 130 (H) × 34.5 (W) × 93.6 (D) |

- (2) The following table lists the performance specifications of the A1SD59J-MIF.

| Item | Performance specifications |
|---------------------|--------------------------------|
| Interface | A1SD59-S2 connection connector |
| Weight | 0.45Kg |
| External Dimensions | 54 (H) × 112 (W) × 148 (D) |

- (3) Cable specifications
AC20MIF-L: 2m

3.2 Buffer Memory

The buffer memories of the A1SD59J module are described below.

The following is an example in which a memory card with an access capacity of 2MB is used.

- (1) The buffer memories 0000H to 07FFH cannot be used because they are used by the system.
- (2) The buffer memories 0800H to 17FFH are in the memory area to gain access to the memory card. One bank represents 8KB.
- (3) A combination of the output signals Y10 to Y17 (For details, see Section 3.4 (2).) with each other enables the banks 0 to 255 to be switched over for accessing.

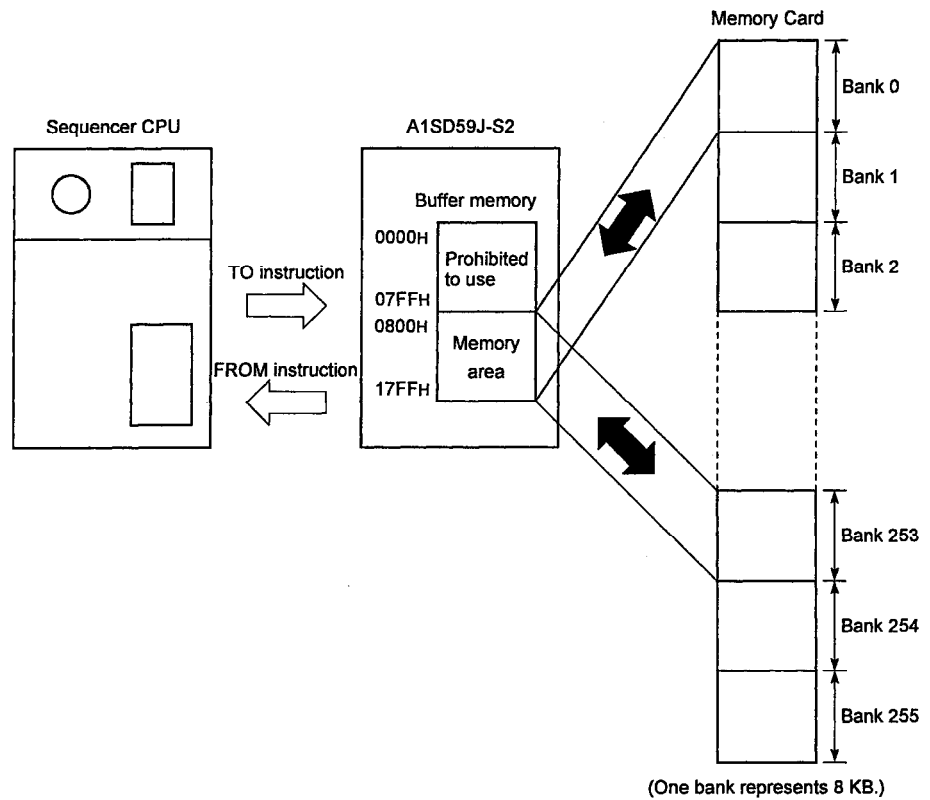

3.3 I/O Signals

The following table lists the I/O signals assigned to the A1SD59J-S2.
 The devices coded with X and Y in the list indicate those when the A1SD59J-S2 is connected to the slot 0.

| Input Signal | | A1SD59J → Sequencer CPU | Output Signal | | Sequencer CPU → A1SD59J | |
|--------------|--|---------------------------|-------------------------------------|-------------------------------------|-------------------------|-----------------------------|
| Device | Signal Name | | Device | Signal Name | | |
| X0 | A1SD59J-MIF connection check | | X0 | For system (use by user prohibited) | | |
| X1 | Module front push-button | Memory card read request | X1 | | | |
| X2 | | Memory card write request | X2 | | | |
| X3 | Write protect signal | | X3 | | | |
| X4 | Memory card access enable | | X4 | | | |
| X5 | Memory card detection | | X5 | | | |
| X6 | Memory card battery detection (BAT1) | | X6 | | | |
| X7 | Memory card battery detection (BAT2) | | X7 | | | |
| X8 | For system (use by user prohibited) | | X8 | | | |
| X9 | | | X9 | | | |
| XA | | | XA | | | |
| XB | | | XB | | | |
| XC | | | XC | | | |
| XD | | | XD | | | |
| XE | | | XE | | | |
| XF | | | XF | | | |
| X10 | For system (use by user prohibited) | | X10 | | | Memory card bank switchover |
| X11 | | | X11 | | | Memory card bank switchover |
| X12 | | | X12 | | | Memory card bank switchover |
| X13 | | | X13 | Memory card bank switchover | | |
| X14 | | | X14 | Memory card bank switchover | | |
| X15 | | | X15 | Memory card bank switchover | | |
| X16 | | | X16 | Memory card bank switchover | | |
| X17 | | | X17 | Memory card bank switchover | | |
| X18 | | | X18 | For system (use by user prohibited) | | |
| X19 | | | X19 | Use by user prohibited | | |
| X1A | | | For system (use by user prohibited) | | X1A | |
| X1B | X1B | | | | | |
| X1C | X1C | | | | | |
| X1D | X1D | | | | | |
| X1E | Used when the A1SD59J module is connected to remote I/O station. | | X1E | | | |
| X1F | Interlocking signals for PFPR and RTOP instructions | | X1F | | | |

| |
|---|
| POINT |
| If "use by user prohibited" signals are used, it may cause malfunction of the system. |

(1) Description of input signals

- X0 : Indicates that the A1SD59J-S2 module is connected normally to the A1SD59J-MIF module through the AC20MIF-L cable.
 OFF: A1SD59J-MIF module not installed.
 ON : A1SD59J-MIF module installed.
- X1 : Read signal (X1) to run data read.
 Create a program to run FROM instruction when this signal (X1) is input.
- X2 : Write signal (X2) to run data write.
 Create a program to run TO instruction when this signal (X2) is input.
- X3 : Indicates the status of the protect switch installed on the memory card.
 OFF: Memory card write enable
 ON : Memory card write prohibited
- X4 : Signals indicating permission/prohibition of access to the memory card.
 Use this signal (X4) as an interlock signal at the time of read/write of data (irrespective of the presence or absence of the memory card).
 OFF: Access prohibited
 ON : Access permitted
- X5 : Indicates whether a memory card is installed or not in the A1SD59J-MIF module.
 OFF: Memory card not installed.
 ON : Memory card installed.
- X6, X7: Indicates the status of the battery inside the memory card by the combination of X6 with X7, whereby the time of replacement of the memory card battery can be recognized easily.

| Battery 1 (X6) | Battery 2 (X7) | Battery Status |
|----------------|----------------|--|
| OFF | OFF | Battery voltage is normal. |
| OFF | ON | Data is stored, but battery must be replaced with a new one. |
| ON | OFF | Data storage is not assured and, therefore, battery must be replaced with a new one. |
| ON | ON | Data storage is not assured and, therefore, battery must be replaced with a new one. |

Caution
 If the memory card is not installed (X5 = OFF), X6 and X7 will be turned ON, and a battery error will be detected.

(2) Description of output signals

The banks 0 to 255 can be switched over by the combination of ON and OFF of Y10 to Y17.

| Bank No. | Y17 | Y16 | Y15 | Y14 | Y13 | Y12 | Y11 | Y10 |
|----------|-----|-----|-----|-----|-----|-----|-----|-----|
| 0 | OFF | OFF | OFF | OFF | OFF | OFF | OFF | OFF |
| 1 | OFF | OFF | OFF | OFF | OFF | OFF | OFF | ON |
| 2 | OFF | OFF | OFF | OFF | OFF | OFF | ON | OFF |
| 3 | OFF | OFF | OFF | OFF | OFF | OFF | ON | ON |
| ⋮ | ⋮ | ⋮ | ⋮ | ⋮ | ⋮ | ⋮ | ⋮ | ⋮ |
| 253 | ON | ON | ON | ON | ON | ON | OFF | ON |
| 254 | ON | ON | ON | ON | ON | ON | ON | OFF |
| 255 | ON | ON | ON | ON | ON | ON | ON | ON |

(3) Read/Write timing

• Read

Bank switchover (Y10 to Y17)

Read request (X1)
(Module push-button switch (READ))

Read

Buffer memory

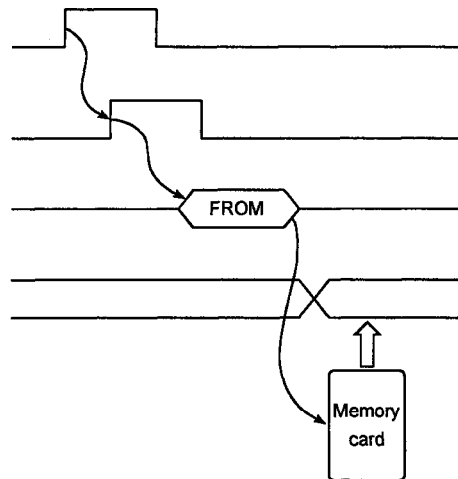

• Write

Bank switchover (Y10 to Y17)

Write request (X2)
(Module push-button switch (Write))

Write

Buffer memory

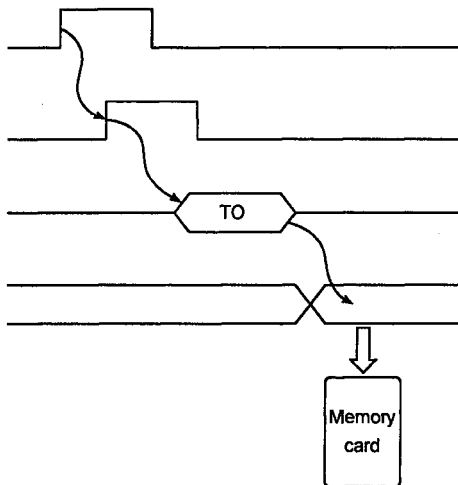

4 Settings and Procedures up to Operation

The section describes the cautions on handling, names of parts, and settings of parts of the A1SD59J module.

4.1 Procedures up to Operation

The following flowchart indicates a procedure up to the operation of the A1SD59J after unpacking it.

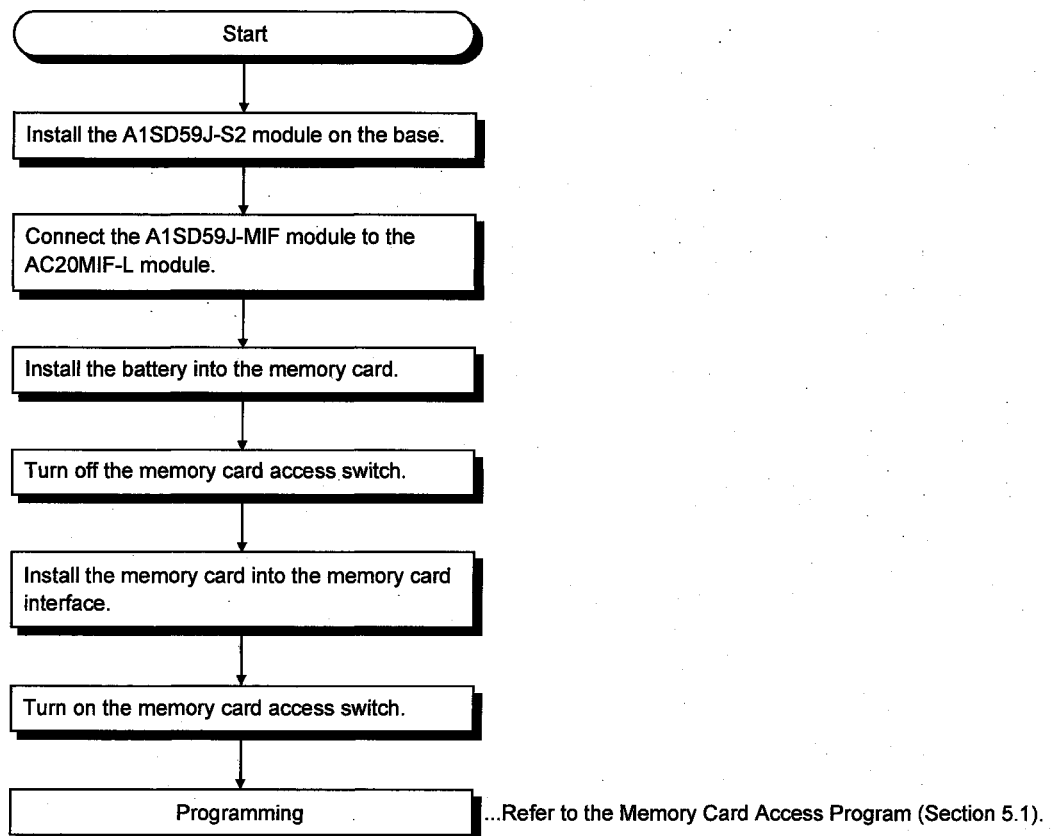



4.2 Cautions on Handling

The cautions on handling of the A1SD59J module are described below.

- (1) The case of the A1SD59J module is made of resin and, therefore, do not drop or subject it to a strong impact.
- (2) Do not remove the printed circuit board of each module from the case.
- (3) Fix the module mounting screws with the torque specified below.

| Screw Location | Tightening Torque Range |
|----------------------------------|-------------------------|
| Module mounting screw (M4 screw) | 78.4 to 117.6N • cm |
| Mounting hook (A1SD59J-MIF) | 62 to 83.5N • cm |

| | |
|---|---|
|  DANGER | <ul style="list-style-type: none"> • Perform installation and wiring after disconnecting the power supply at all phases externally. If the power is not disconnected at all phases an electric shock or product damage may result. |
|---|---|

| | |
|--|---|
|  CAUTION | <ul style="list-style-type: none"> • Make sure foreign objects do not get inside the module, such as dirt and wire chips. If any of these are inside the module, remove them as soon as possible. It may cause fire, trouble or malfunction. • Do not have communication cables bundled with or placed near the main circuit and/or power cables. • Correctly connect the communication cable to the connector of the communication module. After the installation, check the memory card for alignment with the connector. A poor connection could result in erroneous operation. • Before installing and detaching the memory card, turn off the memory card access switch of the A1SD59J-MIF module. Failure to do so may cause data damage. |
|--|---|

4.3 Names of the Parts

This section provides the part names of the A1SD59J-S2 and A1SD59J-MIF.

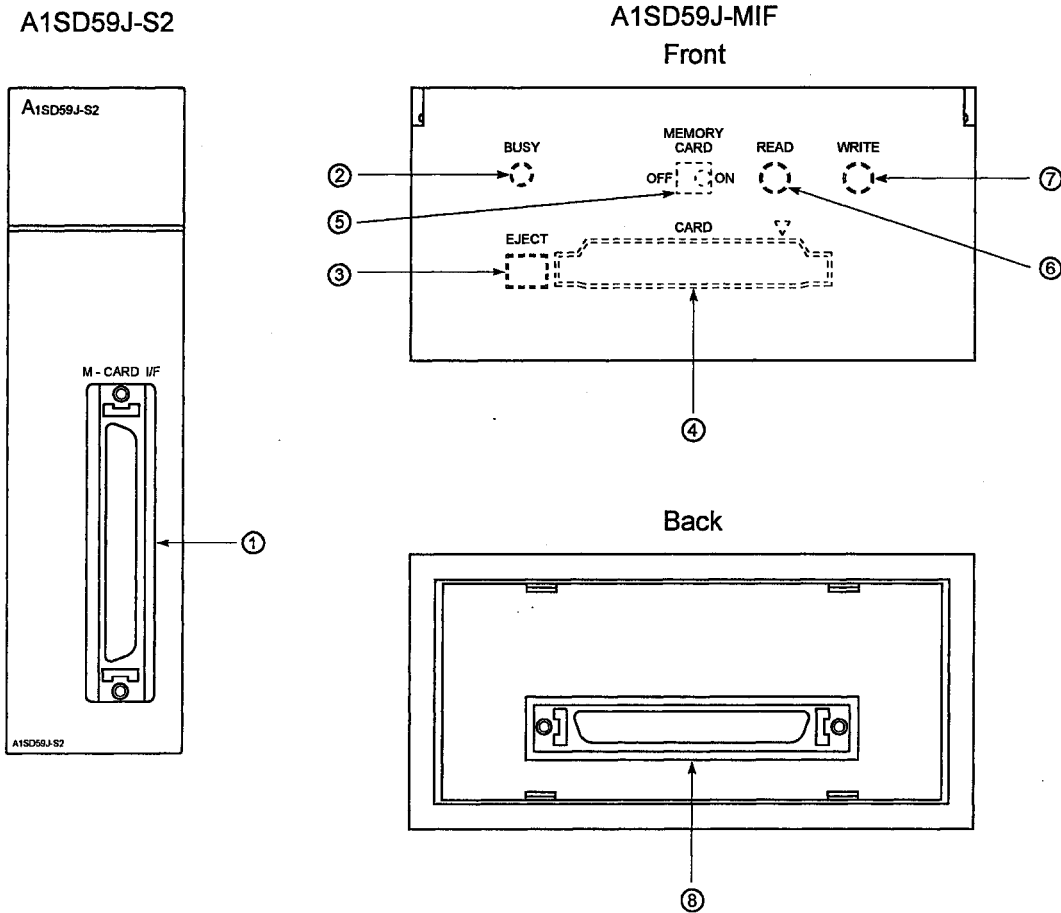

| Number | Name | Description |
|--------|---------------------------------|--|
| ① | Memory card interface | Connection cable connector for connecting the A1SD59J-MIF module. |
| ② | LED display | While the LED lights up, the FROM/TO instruction is run. If the memory card is installed or detached while the LED lights up, data may be damaged. Before installing or detaching the memory card, make sure that the LED goes off. |
| ③ | EJECT button | Press this button to take out the memory card. |
| ④ | Memory card connector | Connector for installing the memory card. Connect the memory card securely to the memory card connector with the ► mark on the memory card matched with the ► mark on the memory card connector. |
| ⑤ | Memory card access switch | This switch is used to generate memory card access enable/prohibited signals. Use these signals (X4) as an interlock at the time of read/write of data. |
| ⑥ | Push-button switch (READ) | This switch is used to generate read signals to run data read. Create the program to run the FROM instruction when this signal (X1) is input. |
| ⑦ | Push-button switch (WRITE) | This switch is used to generate write signals to run data write. Create the program to run the TO instruction when this signal (X2) is input. |
| ⑧ | A1SD59J-S2 connection connector | Connection cable connector for connecting the A1SD59J-S2 module. |

4.4 Push-button Switch (Input Signals (X1, X2) entered by Push-buttons on Front Surface of Module)

Press the desired push-button on the front surface of the module to turn on the signal X corresponding to that push-button.

Though each signal is named, the A1SD59J-S2 module does not function even when the signal is turned on.

As necessary, the user must create an operation output program by using each signal as a start signal.

The input signals X and names of push-buttons are as follows.

| (Input signal) | (Name of push-button) |
|----------------|-----------------------|
| X1 | READ |
| X2 | WRITE |

For the example of use, refer to Section 5.1.

4.5 Setting Environment

Avoid setting A-series sequencers in the environments specified below.

- Ambient temperature outside the temperature range of 0 to 55°C.
- Ambient humidity outside the humidity range of 10 to 90%RH.
- Condensation occurring due to abrupt change in ambient temperature.
- Corrosive gas or inflammable gas is present.
- Abundance of conductive powder, oil mist, salinity, or organic solvent such as dirt and iron particles are present.
- Direct sunshine is present.
- Strong fields or magnetic fields are generated.
- Vibration or impact is given directly to the module.



CAUTION

- Use each sequencer in an environment as specified in the "general specification" in the manual.
- Usage of the module outside the general specification range may cause electric shock, fire, malfunction, product damage or deterioration.

4.6 Installation Method

Install the A1SD59J-MIF module using the mounting hooks furnished with the module.

(1) Installation method

- (a) Install the module from the front side.
- (b) Fix the module at two positions on the side surface of the A1SD59J-MIF module shown in the figure below.

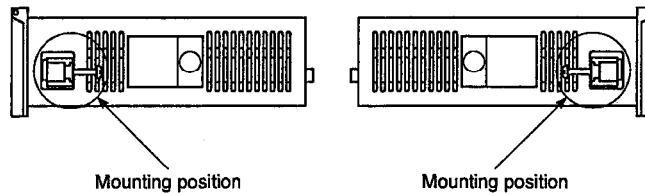

- (c) The installation of the mounting hooks is as shown below.
The range of tightening torque must be 62 to 83.5N • cm.

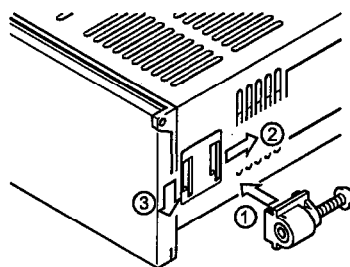

- ① Install the mounting hook into the A1SD59J-MIF module.
- ② Slide the hook in ② direction as shown.
- ③ Slide the mounting hook in the direction along which slots are provided in the mounting hook installation part.
- ④ Fix the A1SD59J-MIF module to the panel with the mounting hook screw.

MEMO

5 Programming

This section describes the programming procedure and programming method to gain access to the memory card.

5.1 Programming for Memory Card Control

As described in Section 3.5, access to the memory card is switched over for each bank (8KB) before being executed. Access to the memory card is executed by TO instruction (write)/FROM instruction (read).

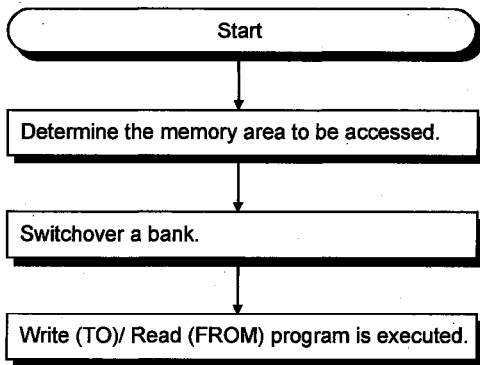

5

Program example

Install the A1SD59J-S2 module into the slot 0 of the main base.
Gain access to each bank from the first address.

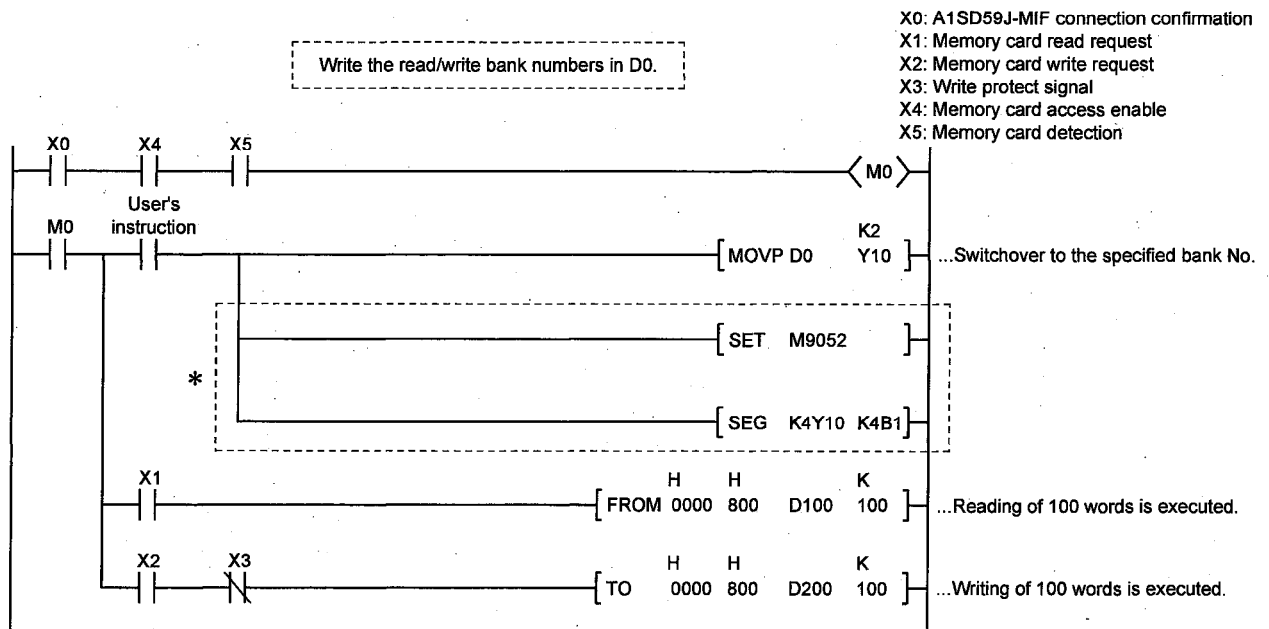

*: In the refresh mode of the PLC CPU I/O control system, refresh the bank changing signal with the partial refresh instruction. If the partial refresh instruction is not executed, the bank changing signal will not be valid till the END processing of the PLC CPU. Therefore, read/write of data from/to the memory card in the same scan as bank changing reads/writes data from/to the old bank.

| |
|--|
| POINT |
| <ul style="list-style-type: none"> • To gain access to the memory card, the actual address of the memory card must not be designated. Use 800H to 17FFH of the buffer memory for each selection of the bank. • The access is enabled from any address of 800H to 17FFH of the buffer memory. • The write/read capacity is 8KB max. for each write/read. |

5.1.1 Example of application of memory card

The memory card can be used freely in any module according to the use application of a user.

For example, it can be used for a change in setting values of a timer and a counter.

In the example shown below, the memory card is used as an extension data register area because the number of registers is not sufficient in the sequencer CPU.

In access between the sequencer CPU and memory card, the block 1 (equivalent to one bank on memory card) on the file register of the sequencer CPU is used for writing and the block 2 is used for reading.

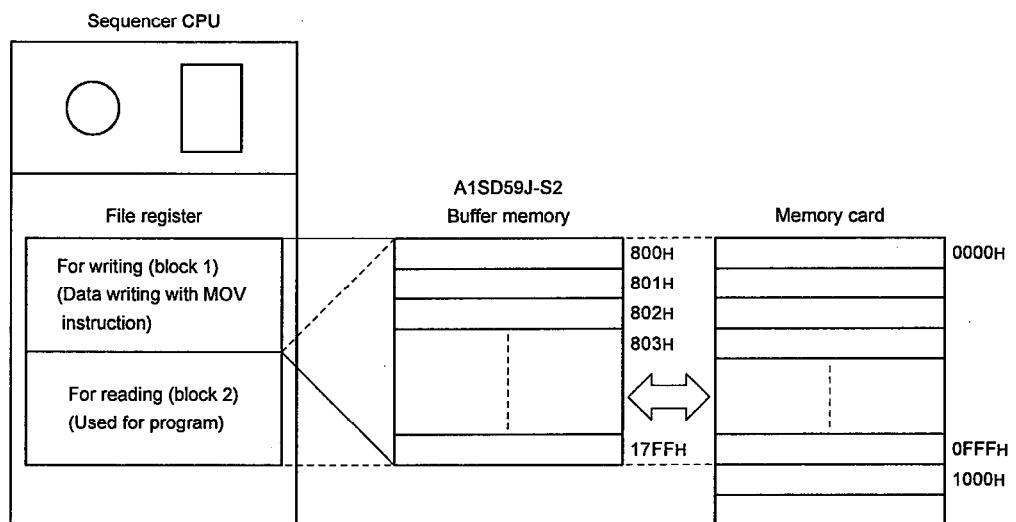

The example above shows that one bank on the memory card is used for preparing 4096 extension data registers.

Depending on the memory card to be used and when it is used on the extension data registers, a maximum number of 1048576 extension data registers can be prepared.

6 Maintenance

This section describes the maintenance (storage of the module, replacement of the battery) of the A1SD59J module.

For the maintenance of the other modules such as power supply modules, CPU modules, I/O modules and special modules, refer to the User's Manual of the applicable module.

6.1 Storage of Module

When storing the sequencer itself or the sequencer which is installed in the control panel or machine, avoid doing it in those environments specified below.

- (1) Ambient temperature outside the temperature range of -20 to 75°C.
- (2) Ambient humidity outside the humidity range of 10 to 90%RH.
- (3) Condensation occurring due to abrupt change in ambient temperature.
- (4) Abundance of conductive powder, corrosive gas, oil mist or salinity such as dirt and iron particles is present.

6.2 Replacing Battery

The time and procedure for replacement of the battery are described below.

6.2.1 Battery replacement time

See Section 3.4 (1) Detection of Memory Card Battery.

6.2.2 Battery replacement procedure

The battery replacement procedure is described below.

Because the memory card battery is shipped separately from the battery holder, when using the RAM memory, set the battery holder as follows.

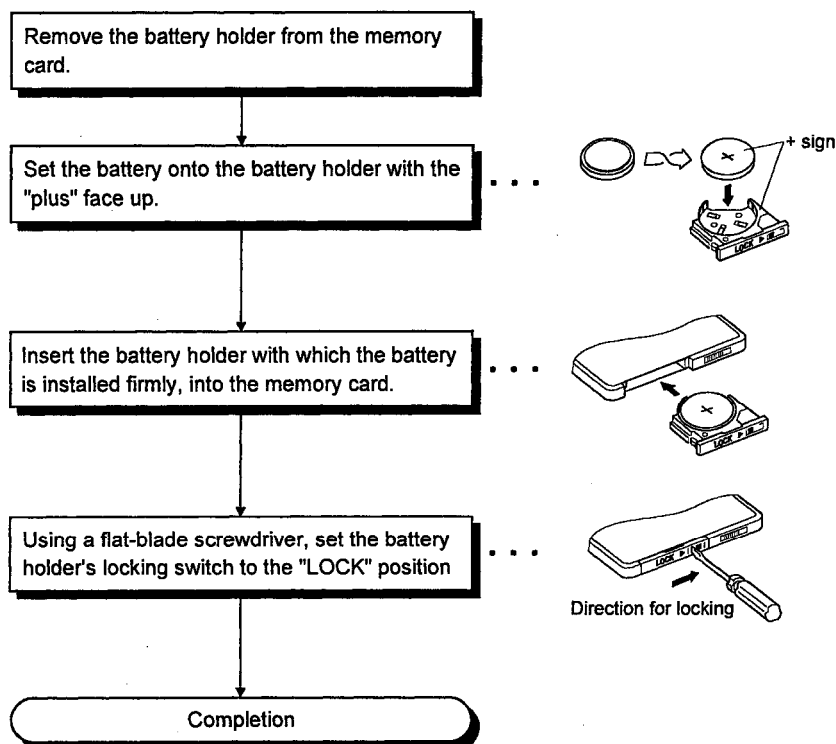

7 Troubleshooting

7.1 Flowchart when the Memory Card cannot be accessed normally

The troubleshooting procedure on the A1SD59J module is described below.

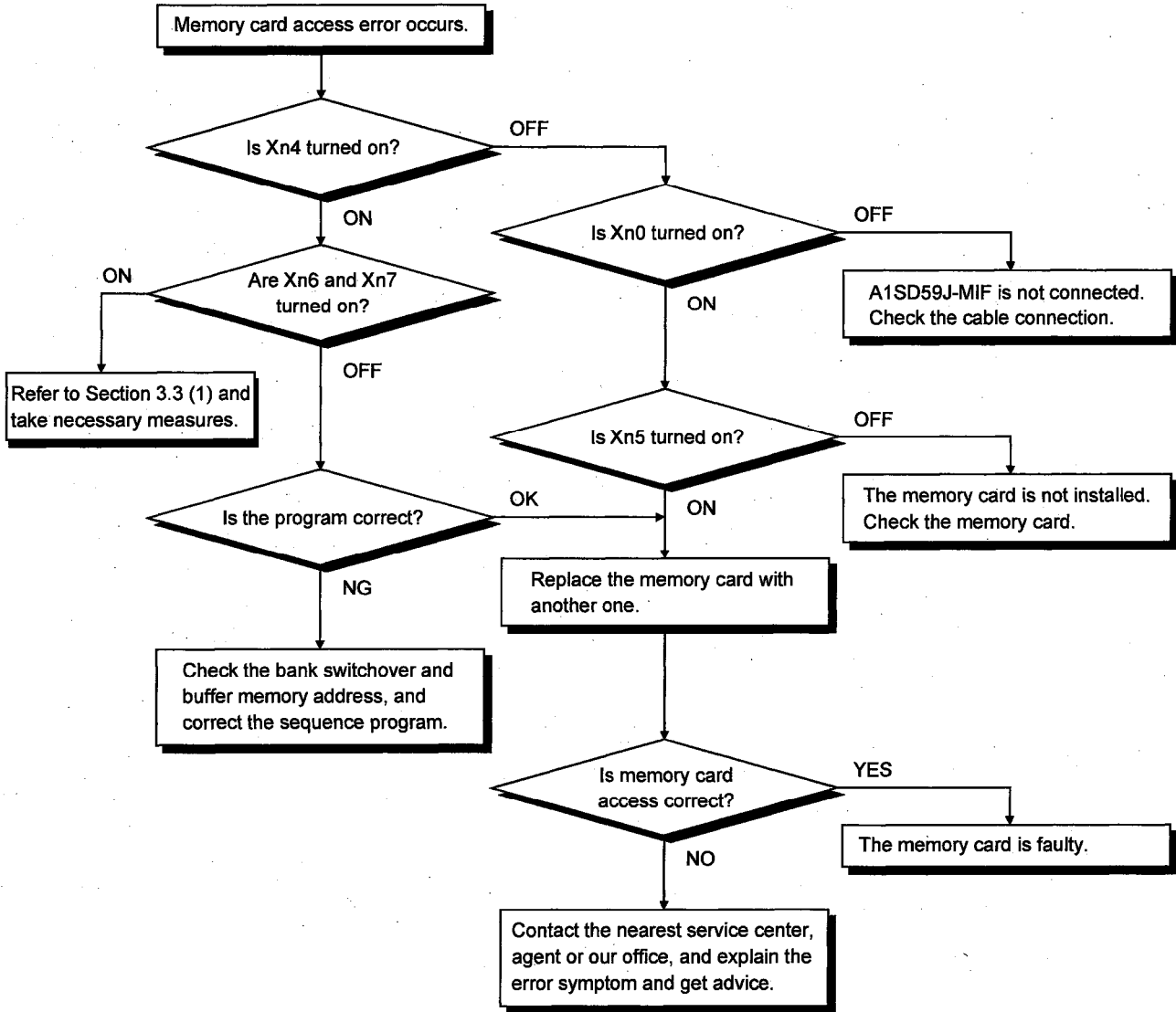

7

MEMO

Appendix

Appendix-1 External Dimensions Diagram

(1) A1SD59J-S2

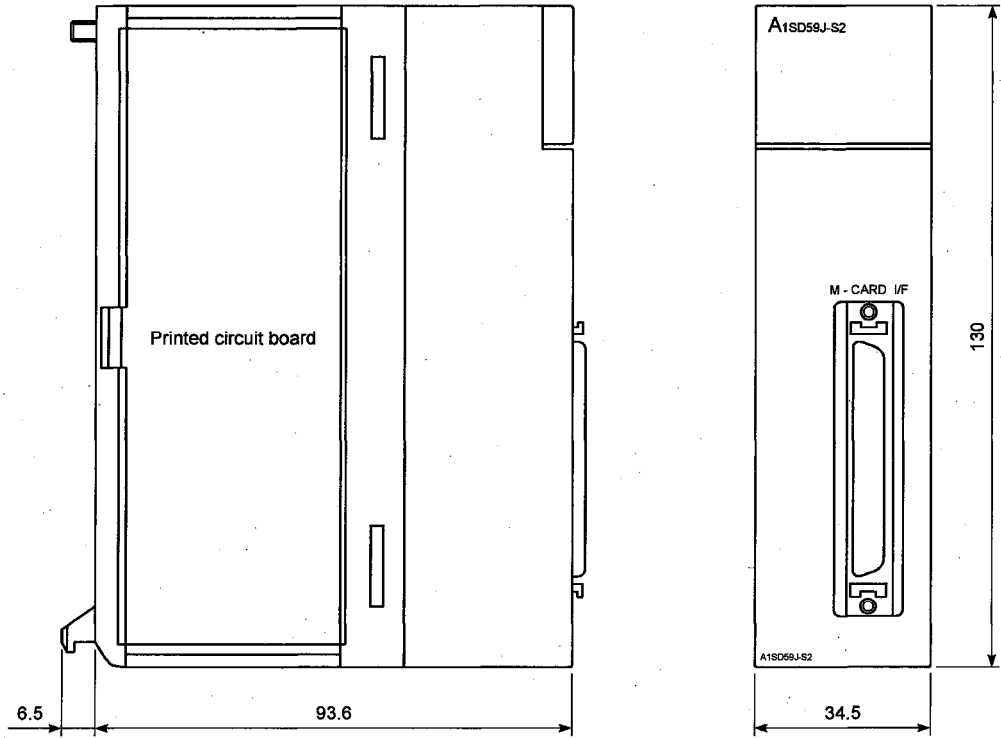

App

(1) A1SD59J-MIF

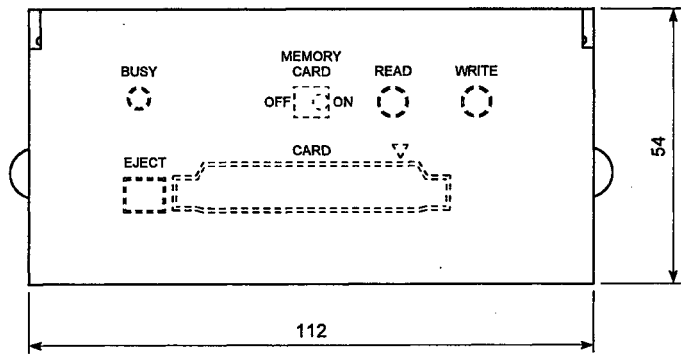
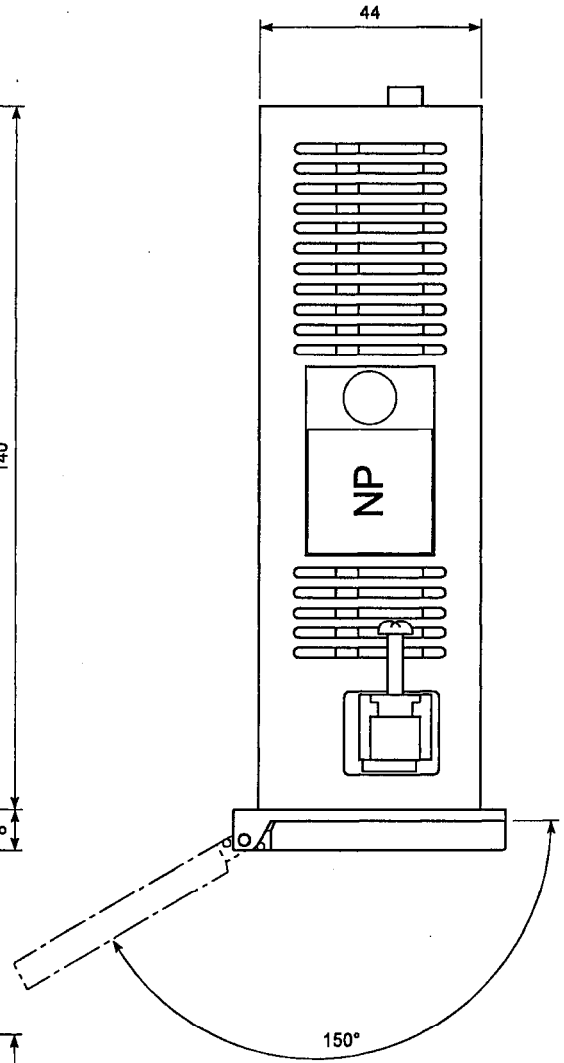
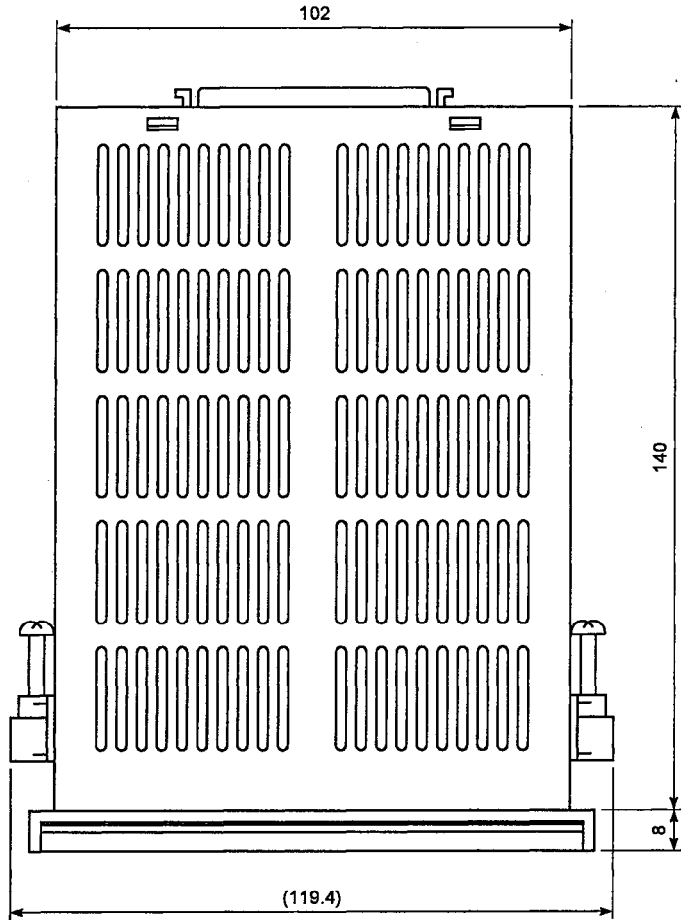

Appendix 2 Transportation Precautions

When transporting lithium batteries, make sure to treat them based on the transport regulations.

Appendix 2.1 Controlled models

The batteries for Memory card is classified as follows:

| Product name | Model | Product supply status | Classification for transportation |
|--------------|---|---|-----------------------------------|
| Memory card | Q1MEM-64S, Q1MEM-128S, Q1MEM-256S, Q1MEM-512S, Q1MEM-1MS, Q1MEM-2MS, | Packed with lithium coin battery (BR2325) | Non-dangerous goods |

Appendix 2.2 Transport guidelines

Comply with IATA Dangerous Goods Regulations, IMDG code and the local transport regulations when transporting products after unpacking or repacking, while Mitsubishi ships products with packages to comply with the transport regulations.
Also, contact the transporters.

WARRANTY

Please confirm the following product warranty details before starting use.

1. Gratis Warranty Term and Gratis Warranty Range

If any faults or defects (hereinafter "Failure") found to be the responsibility of Mitsubishi occurs during use of the product within the gratis warranty term, the product shall be repaired at no cost via the dealer or Mitsubishi Service Company. Note that if repairs are required at a site overseas, on a detached island or remote place, expenses to dispatch an engineer shall be charged for.

[Gratis Warranty Term]

The gratis warranty term of the product shall be for one year after the date of purchase or delivery to a designated place.

Note that after manufacture and shipment from Mitsubishi, the maximum distribution period shall be six (6) months, and the longest gratis warranty term after manufacturing shall be eighteen (18) months. The gratis warranty term of repair parts shall not exceed the gratis warranty term before repairs.

[Gratis Warranty Range]

- (1) The range shall be limited to normal use within the usage state, usage methods and usage environment, etc., which follow the conditions and precautions, etc., given in the instruction manual, user's manual and caution labels on the product.
- (2) Even within the gratis warranty term, repairs shall be charged for in the following cases.
 1. Failure occurring from inappropriate storage or handling, carelessness or negligence by the user. Failure caused by the user's hardware or software design.
 2. Failure caused by unapproved modifications, etc., to the product by the user.
 3. When the Mitsubishi product is assembled into a user's device, Failure that could have been avoided if functions or structures, judged as necessary in the legal safety measures the user's device is subject to or as necessary by industry standards, had been provided.
 4. Failure that could have been avoided if consumable parts (battery, backlight, fuse, etc.) designated in the instruction manual had been correctly serviced or replaced.
 5. Failure caused by external irresistible forces such as fires or abnormal voltages, and Failure caused by force majeure such as earthquakes, lightning, wind and water damage.
 6. Failure caused by reasons unpredictable by scientific technology standards at time of shipment from Mitsubishi.
 7. Any other failure found not to be the responsibility of Mitsubishi or the user.

2. Onerous repair term after discontinuation of production

- (1) Mitsubishi shall accept onerous product repairs for seven (7) years after production of the product is discontinued. Discontinuation of production shall be notified with Mitsubishi Technical Bulletins, etc.
- (2) Product supply (including repair parts) is not possible after production is discontinued.

3. Overseas service

Overseas, repairs shall be accepted by Mitsubishi's local overseas FA Center. Note that the repair conditions at each FA Center may differ.

4. Exclusion of chance loss and secondary loss from warranty liability

Regardless of the gratis warranty term, Mitsubishi shall not be liable for compensation to damages caused by any cause found not to be the responsibility of Mitsubishi, chance losses, lost profits incurred to the user by Failures of Mitsubishi products, damages and secondary damages caused from special reasons regardless of Mitsubishi's expectations, compensation for accidents, and compensation for damages to products other than Mitsubishi products and other duties.

5. Changes in product specifications

The specifications given in the catalogs, manuals or technical documents are subject to change without prior notice.

6. Product application

- (1) In using the Mitsubishi MELSEC programmable logic controller, the usage conditions shall be that the application will not lead to a major accident even if any problem or fault should occur in the programmable logic controller device, and that backup and fail-safe functions are systematically provided outside of the device for any problem or fault.
- (2) The Mitsubishi general-purpose programmable logic controller has been designed and manufactured for applications in general industries, etc. Thus, applications in which the public could be affected such as in nuclear power plants and other power plants operated by respective power companies, and applications in which a special quality assurance system is required, such as for Railway companies or National Defense purposes shall be excluded from the programmable logic controller applications.

Note that even with these applications, if the user approves that the application is to be limited and a special quality is not required, application shall be possible.

When considering use in aircraft, medical applications, railways, incineration and fuel devices, manned transport devices, equipment for recreation and amusement, and safety devices, in which human life or assets could be greatly affected and for which a particularly high reliability is required in terms of safety and control system, please consult with Mitsubishi and discuss the required specifications.

A1SD59J-S2/MIF Memory Card Interface Module

User's Manual

| | |
|--------------------------|----------------|
| MODEL | A1SD59J-S2-U-E |
| MODEL CODE | 13JR05 |
| SH(NA)-080056-B(0312)MEE | |

 **MITSUBISHI ELECTRIC CORPORATION**

HEAD OFFICE : 1-8-12, OFFICE TOWER Z 14F HARUMI CHUO-KU 104-6212, JAPAN
NAGOYA WORKS : 1-14 , YADA-MINAMI 5-CHOME , HIGASHI-KU, NAGOYA , JAPAN

When exported from Japan, this manual does not require application to the Ministry of Economy, Trade and Industry for service transaction permission.

Specifications subject to change without notice.