

CL1XY8-DR1B2 CC-Link/LT Remote I/O Module

Thank you very much for purchasing this product.

Please read this manual thoroughly before starting to use the product and handle the product properly.

User's Manual

MODEL	CL1XY8-DR1B2
MANUAL Number	JY997D04501E
Date	September 2008

CC-Link/LT

SAFETY PRECAUTIONS

(Read these precautions before using)

Please read this manual carefully and pay special attention to safety in order to handle this product properly. Also pay careful attention to safety and handle the module properly.

These precautions apply only to Mitsubishi equipment. Refer to the user's manual of the CPU module to use for a description of the PLC system safety precautions.

These SAFETY PRECAUTIONS classify the safety precautions into two categories: "DANGER" and "CAUTION".

DANGER Procedures which may lead to a dangerous condition and cause death or serious injury if not carried out properly.

CAUTION Procedures which may lead to a dangerous condition and cause superficial to medium injury, or physical damage only, if not carried out properly.

Depending on circumstances, procedures indicated by **CAUTION** may also be linked to serious results.

In any case, it is important to follow the directions for usage.

Store this manual in a safe place so that you can take it out and read it whenever necessary. Always forward it to the end user.

DESIGN PRECAUTIONS

DANGER

- Configure an interlock circuit in a sequence program so that the system operates on the safety side using the communication status information in the event the data link falls into a communication problem. Otherwise, erroneous output and malfunction may result in accidents.
- Remote input and output can not be switched ON or OFF when a problem occurs in the remote I/O modules. Therefore build an external monitoring circuit that will monitor any input signals that could cause a serious accident.

CAUTION

- Do not have control cables and communication cables bundled with or placed near by the main circuit and/or power cables. Wire those cables at least 100mm(3.94 inch) away from the main circuit and/or power cables. It may cause malfunction due to noise interference.
- Use the module and the flat cable dedicated to CC-Link/LT without applying any force on them.
- Otherwise, such cables may be broken or fail.

INSTALLATION PRECAUTIONS

CAUTION

- Use the module in an environment that meets the general specifications contained in this manual. Using this module in an environment outside the range of the general specifications could result in electric shock, fire, erroneous operation, and damage to or deterioration of the product.
- Do not directly touch the module's conductive parts. Doing so could cause malfunction or trouble in the module.
- Tighten the module securely using DIN rail or installation screws within the specified torque range.
- If the screws are too loose, the module may drop from its installation position, short circuit, or malfunction. If the screws are too tight, the screws may be damaged, which may cause the module to drop from its installation position or short circuit.
- Install the module on a flat surface.
- If the mounting surface has concave and/or convex, an excessive force may be applied on the module, and nonconformity may be caused.

WIRING PRECAUTIONS

DANGER

- Perform installation and wiring after disconnecting the power supply at all phases externally. If the power is not disconnected at all phases an electric shock or product damage may result.

CAUTION

- Terminal screws which are not to be used must be tightened always. Otherwise there will be a danger of short circuit against the bare solderless terminals.
- Perform correct wiring for the module according to the product's rated voltage and terminal arrangement. Connecting to a power supply different from rating or miss-wiring may cause fire, product failure or malfunction.
- Fix terminal screws securely within the regulated torque. Loose terminal screws may cause fire and/or malfunction.
- If the terminal screws are too tight, it may cause short circuit or erroneous operation due to damage of the screws.
- Make sure foreign objects do not get inside the module, such as dirt and wire chips. It may cause fire, product failure or malfunction.
- Attach a warning label (hazard symbol 417-IEC-5036) concerning the electric shock to the location.

STARTING AND MAINTENANCE PRECAUTIONS

DANGER

- Do not touch the terminals when the power is ON. It may cause an electric shock or malfunction.
- Perform cleaning the module or retightening of terminal screws after turning OFF the all external power supply for sure. Failure to do so may cause failure or malfunction of the modules

CAUTION

- Do not disassemble or modify the module. Doing so may cause failure, malfunction, injury, or fire.
- The module case is made of resin; do not drop it or subject it to strong shock. A module damage may result.
- Make sure to switch all phases of the external power supply OFF before installing or removing the module to/from the panel. Failure to do so may cause failure or malfunction of the modules.

DISPOSAL PRECAUTIONS

DANGER

- When disposing of this product, treat it as industrial waste.

TRANSPORTATION AND MAINTENANCE PRECAUTIONS

CAUTION

- During transportation avoid any impact as the module is a precision instrument. Doing so could cause trouble in the module.
- If it is necessary to check the operation of module after transportation, in case of any impact damage.

Notification of CE marking

This notification does not guarantee that an entire mechanical module produced in accordance with the contents of the notification comply with the following standards. Compliance to EMC standards of the entire mechanical module should be checked by the user / manufacturer. Compliance to LVD standards of the entire mechanical module should be checked by the user / manufacturer.

Standards with which this product complies

Type : Programmable Controller (Open Type Equipment) Remote I/O module
 Models : Products manufactured:
 from November 1st, 2002 to April 30th, 2006 are compliant with EN61000-6-4 and EN61131-2:1994+A11:1996+A12:2000
 after May 1st, 2006 are compliant with EN61131-2:2003

Electromagnetic Compatibility Standards (EMC)	Remark
EN61000-6-4:2001 Electromagnetic compatibility -Generic standards - Emission standard for Industrial environment	Compliance with all relevant aspects of the standard. (Radiated Emissions and Mains Terminal Voltage Emissions)
EN61131-2:1994/A11:1996/A12:2000 Programmable controllers -Equipment requirements and tests	Compliance with all relevant aspects of the standard. (RF Immunity, Fast transients, ESD and Damped oscillatory wave)
EN61131-2: 2003 Programmable controllers -Equipment requirements and tests	Compliance with all relevant aspects of the standard. (Radiated Emissions, Mains Terminal Voltage Emissions, RF Immunity, Fast Transients, ESD, Surge Voltage drops and interruptions, Conducted and Power magnetic fields)

Low Voltage Standards (LVD)	Remark
EN61131-2:1994/A11:1996 /A12:2000 i2003 Programmable controllers -Equipment requirements and tests	The equipment has been assessed as a component for fitting in a suitable enclosure which meets the requirements of EN61131-2:1994 + A11:1996 + A12:2000, i2003

For more details please contact the local Mitsubishi Electric sales site.
 - Notes For compliance to EMC LVD regulation.
 It is necessary to install the CL1 series module in a shielded metal control panel.

1. Outline of Product

This product is a terminal block type composite I/O module connected to CC-Link/LT.

This product has four input points (24V DC) and four output points (relay output).

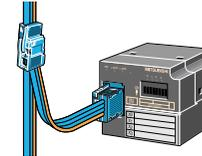

2. Name and Setting of Each Part and Terminal Arrangement

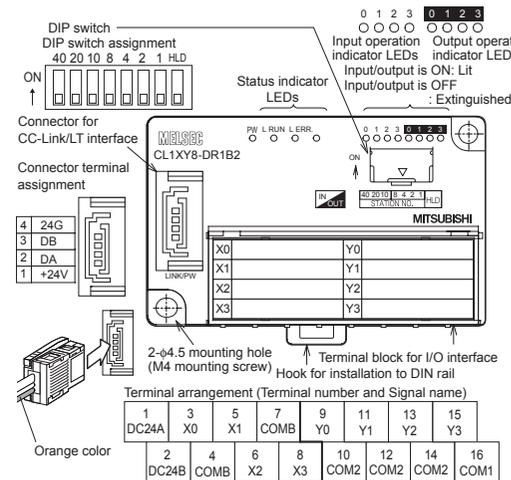

Name	Description
PW	ON while the power is supplied.
L RUN	ON while normal operation is executed.
Status indicator LEDs	ON: When a communication error or DIP switch setting error occurred Fllickering at a constant interval: When the setting of the DIP switch was changed while the power was supplied (even while the LED is flickering, the operation continues. The new setting becomes valid when the power is turned OFF once, then ON again.) L ERR: Flickering at a intermittent interval: When a terminal resistor is not attached or when the module or a connection cable is affected by noise
I/O operation indicator LEDs	ON while the input or output is ON. Extinguished while the input or output is OFF.
Connector for CC-Link/LT interface	Connector for CC-Link/LT communication line/module power supply (24G/DB/DA/+24V)
Terminal block for I/O interface	Terminal block to connect input signals, output signals, I/O power supply and load power supply

Name	Description																
Station number setting switches	Set the 10's digit of the station No. using "STATION NO. 10". "STATION NO. 20" and "STATION NO. 40". Set the 1's digit of the station No. using "STATION NO. 1", "STATION NO. 2", "STATION NO. 4" and "STATION NO. 8". Factory default = All bits are OFF. Make sure to set the station No. in the range from 1 to 64. If any station No. outside the range from 1 to 64 is set, it is regarded as an error and the L ERR. LED lights. Example: When setting the station No. to "32", set the DIP switch as follows. <table border="1"> <tr> <th>Station No.</th> <th>40</th> <th>20</th> <th>10</th> <th>8</th> <th>4</th> <th>2</th> <th>1</th> </tr> <tr> <td>32</td> <td>OFF</td> <td>ON</td> <td>ON</td> <td>OFF</td> <td>OFF</td> <td>ON</td> <td>OFF</td> </tr> </table>	Station No.	40	20	10	8	4	2	1	32	OFF	ON	ON	OFF	OFF	ON	OFF
Station No.	40	20	10	8	4	2	1										
32	OFF	ON	ON	OFF	OFF	ON	OFF										
Response time setting switch	HLD Holds the output (when an error has occurred). ON: Holds the output. OFF: Clears the output.																

3. Installation

The CL1XY8-DR1B2 can be installed to DIN rail or directly installed using mounting screws.

Each installation procedure is described below.

3.1 Installation to DIN rail

Align the upper DIN rail installation groove in the module with the DIN rail 1), and press the module in that status 2). When removing the module, pull downward the hook for installation to DIN rail 3), then remove the module 4).

DIN rail mounting screw pitch

When installing the module to the DIN rail, tighten the mounting screws at the pitch of 200mm(7.87") or less.

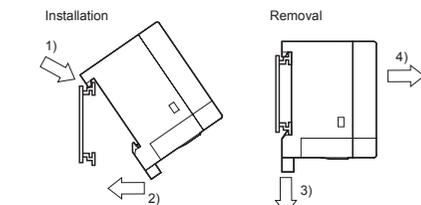

Applicable DIN rail | TH35-7.5Fe and TH35-7.5Al

3.2 Direct installation

Screw-tighten the module by attaching M4 screws to the upper and lower mounting holes (two holes in all) provided in the module. Install the module so that the clearance of 1 to 2mm (0.04" to 0.08") is assured for each module.

Applicable screw | M4 × 0.7mm(0.03") × 16mm(0.63") or more
 (Tightening torque range: 78 to 108 N-cm)

4. Wiring

4.1 External wiring

The input terminals of the CL1XY8-DR1B2 can be wired as positive common or negative common depending on the used sensor.

Positive common

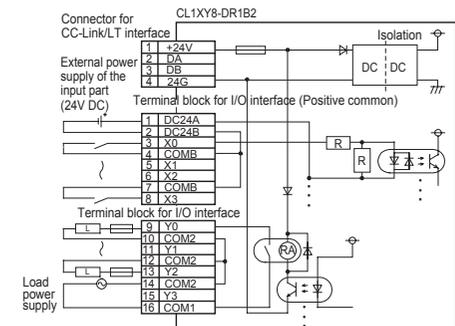

Negative common

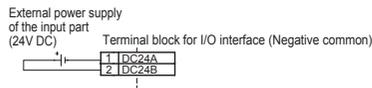

4.2 Connection to sensor

Positive common (NPN)

- When using a two-wire type sensor
- When using a three-wire type sensor

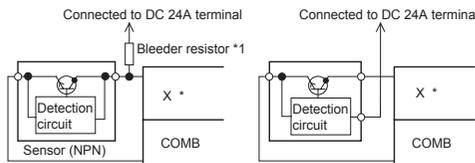

- When using a three-wire type sensor (when using the power supply for sensor other than 24V DC)

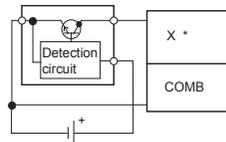

Negative common (PNP)

- When using a two-wire type sensor
- When using a three-wire type sensor

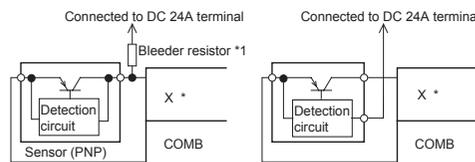

- When using a three-wire type sensor (when using the power supply for sensor other than 24V DC)

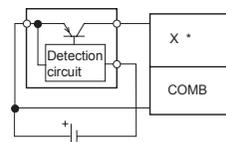

Replace * in the figure with the used input No.

Notes:

- *1 Bleeder resistor
When connecting a two-wire type sensor or input equipment containing a parallel resistor, select a sensor or equipment whose leakage current is 1.7mA or less.
If the leakage current is more than 1.7mA, connect a bleeder resistor obtained in the following calculation formula.
Circuit image

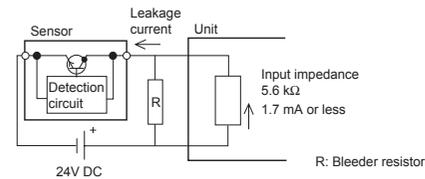

$$R(k\Omega) < 1.7(mA) / \text{Leakage current}(mA) - 1.7(mA) \times 5.6(k\Omega)$$

The power capacity W of the bleeder resistor R is as follows:

$$W = (\text{Input voltage})^2/R$$

- Make sure that both the ON and OFF time of the input signal are 1.5ms or more.

4.3 Crimp-style terminal

For I/O wiring, use crimp-style terminals of the following dimensions.

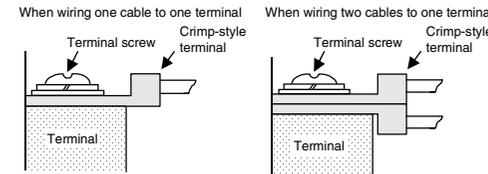
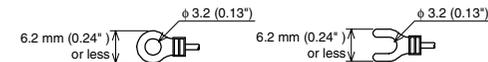

Applicable crimp-style terminal	<ul style="list-style-type: none"> RAV1.25-3 V1.25-3 (manufactured by JST Mfg. Co., Ltd.) 1.25-3 and TG 1.25-3 (manufactured by NICHIFU Co., Ltd.)
	Applicable wire size 0.3 to 1.25 mm ²

Use a crimp-style terminal in a status in which no force is applied on the cable.

4.4 Module terminal screw

Tighten the terminal screws (M3 screws) on the terminal block with a tightening torque of 42 to 58 N·cm.

5. Specifications

5.1 General specifications

Item	Specification	
Operating ambient temperature	0 to 55°C (32 to 131°F)	
Storage ambient temperature	-25 to 75°C (-13 to 167°F)	
Operating ambient humidity	5 to 95%RH: Dew condensation shall not be considered.	
Storage ambient humidity	5 to 95%RH: Dew condensation shall not be considered.	
Vibration resistance	When intermittent vibration is present	
	Frequency	Acceleration
	10 to 57Hz	—
	57 to 150Hz	9.8m/s ²
When continuous vibration is present		Number of times of sweep 10 times in each of X, Y and Z directions (for 80 min)
Frequency	Acceleration	
10 to 57Hz	—	
57 to 150Hz	4.9m/s ²	
Shock resistance	147 m/s ² , 3 times in each of X, Y and Z directions	
Operating ambience	Corrosive gas shall not be present.	
Operating altitude	2,000m(6561'8") or less (*1)	
Installation location	Inside control panel (*2)	
Overvoltage category	II or less (*3)	
Pollution level	2 or less (*4)	

Notes:

- *1 The module cannot be used in an environment pressurized above the atmospheric pressure which can be generated around the altitude of 0 m. If the module is used in such an environment, it may fail.
*2 The module can be used in any environment even outside the control panel as far as the requirements of the ambient operating temperature, the ambient operating humidity, etc. are satisfied.
*3 This indicates the section of the power supply to which the equipment is assumed to be connected between the public electrical power distribution network and the machinery within premises. Category II applies to equipment for which electrical power is supplied from fixed facilities.
The surge voltage withstand level for up to the rated voltage of 300V is 2500V.

*4 This index indicates the degree of conductive generating substances in the environment in which the module is used. The degree of contamination 2 indicates that contamination is caused by generation of only non-conductive substances.
In this degree, however, temporary conduction may be caused by accidental condensation.

5.2 Input specifications

Item	Specification
Input method	DC input (External power supply of the input part)
Number of inputs	4 points
Isolation method	Isolation with photocoupler
Rated input voltage	24V DC
Rated input current	Approx. 4 mA
Operating voltage range	20.4 to 28.8V DC (24V DC -15% to +20%) Ripple ratio: Within 5%
Max. simultaneous ON input points	100% (at 24V DC)
ON voltage/OFF current	19 V or more/3 mA or more
OFF voltage/OFF current	11 V or less/1.7 mA or less
Input resistance	5.6 kΩ
Response time	OFF→ON
	ON→OFF
Common wiring method	1.5 ms or less (at 24V DC)
	1.5 ms or less (at 24V DC)
Common wiring method	4 points/1 common (2 points)
	(terminal block two-wire type)

5.3 Output specifications

Item	Specification
Output method	Relay output
Number of outputs	4 points
Insulation method	Mechanical insulation
Rated load voltage	250V AC/30V DC or less
Max. load current	2A/point 4 A/1 common
Response time	OFF→ON
	ON→OFF
Common wiring method	Approx. 10ms or less
	Approx. 10ms or less
Internal protection for outputs	4 points/1 common (3points)
	(terminal block two-wire type)
Internal protection for outputs	Internal protection circuit none
	Please connect the fuse in the connected load outside.

5.4 Performance specifications

Item	Specification
Module power supply	Voltage
	Current consumption
	Initial current
Number of stations occupied	Max. allowable momentary power failure period
	PS1:1ms
Noise durability	4-, 8- or 16-point mode: 1 station
Withstand voltage	DC type: 500 Vp-p
	AC type: 1,000 Vp-p
Isolation resistance	Noise width: 1 μs
	Cycle: 25 to 60 Hz (by noise simulator)
Protection class	AC type: 1,500V AC for 1 min
	DC type: 500V AC for 1 min
I/O part connection method	10 MΩ or more between primary area (external DC terminal) and secondary area (internal circuit) by 500V DC megger
	IP1X
Module installation method	Connection with terminal block
	DIN rail installation, mounted by screws of type M4 × 0.7mm(0.03") × 16mm(0.63") or larger Can be installed in six directions
Mass (weight)	0.11kg (0.24lbs)
	200V AC - 1.5 A, 240V AC - 1 A (COSφ = 0.7): 100,000 times or more
Contact life	200V AC - 1 A, 240V AC - 0.1 A (COSφ = 0.35): 100,000 times or more
	24V DC - 1 A, 100V DC - 0.1 A (L/R = 7 ms): 100,000 times or more

6. Outside Dimensions

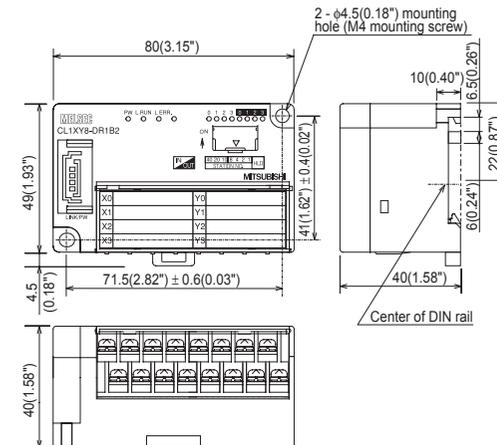

Unit: mm(inches)

This manual confers no industrial property rights or any rights of any other kind, nor does it confer any patent licenses. Mitsubishi Electric Corporation cannot be held responsible for any problems involving industrial property rights which may occur as a result of using the contents noted in this manual.

Warranty

Mitsubishi will not be held liable for damage caused by factors found not to be the cause of Mitsubishi; machine damage or lost profits caused by faults in the Mitsubishi products; damage, secondary damage, accident compensation caused by special factors unpredictable by Mitsubishi; damages to products other than Mitsubishi products; and to other duties.

For safe use

- This product has been manufactured as a general-purpose part for general industries, and has not been designed or manufactured to be incorporated in a device or system used in purposes related to human life.
- Before using the product for special purposes such as nuclear power, electric power, aerospace, medicine or passenger movement vehicles, consult with Mitsubishi.
- This product has been manufactured under strict quality control. However when installing the product where major accidents or losses could occur if the product fails, install appropriate backup or failsafe functions in the system.

Country/Region	Sales office/Tel	Country/Region	Sales office/Tel
U.S.A.	Mitsubishi Electric Automation, Inc. 500 Corporate Woods Parkway, Vernon Hills, IL 60061 U.S.A. Tel: +1-847-478-2100	Hong Kong	Mitsubishi Electric Automation (Hong Kong) Ltd. 10th Floor, Manulife Tower, 169 Electric Road, North Point, HongKong Tel: +852-2887-8870
Brazil	MELCO-TEC Av. Paulista 1439, conj.74, Bela Vista CEP: 01311-200 Sao Paulo-SP-Brasiz Tel: +55-11-3285-1840	China	Mitsubishi Electric Automation (Shanghai) Ltd. 17F, ChuangXing Financial Center, No. 288 West Nanjing Road, Shanghai China 200003 Tel: +86-21-2322-3030
Germany	Mitsubishi Electric Europe B.V. German Branch Gothaer Strasse 8, D-40880 Ratingen, Germany Tel: +49-2102-486-0	Taiwan	Setsuyo Enterprise Co., Ltd. 6F No.105 Wu Kung 3rd Rd, Wu-Ku Hsiang, Taipei Hsien, 248, Taiwan Tel: +886-2-2299-2489
U.K.	Mitsubishi Electric Europe B.V. UK Branch Travellers Lane, Hatfield, Hertfordshire, AL10 8XB, U.K. Tel: +44-1707-276100	Korea	Mitsubishi Electric Automation Korea Co., Ltd. 3F, 1480-6, Gayang-Dong, Gangseo-Gu, Seoul, 157-200, Korea Tel: +82-2-8690-9592
Italy	Mitsubishi Electric Europe B.V. Italian Branch VIALE COLLEONE 1-20041 Agrate Brianza (Milano), Italy Tel: +390-39-60531	Singapore	Mitsubishi Electric Building, Singapore 159943 Tel: +65-6470-2460
Spain	Mitsubishi Electric Europe B.V. Spanish Branch C/ra. de Rub 76-80-AC, 420, E-08190 Sant Cugat del Valles (Barcelona), Spain Tel: +34-93-565-3131	Thailand	Mitsubishi Electric Automation (Thailand) Co., Ltd. Bang-Chan Industrial Estate No.111, Soi Sertthai 54, 1 Kanasaya, A Kanasaya, Bangkok 10230 Tel: +66-2-617-1326
France	Mitsubishi Electric Europe B.V. French Branch 25, Boulevard des Bouvets, F-92741 Nanterre Cedex, France Tel: +33-1-55858568	India	Measure Systems Pvt. Ltd. Sapphire House EL-3 J-Block MIDC (Bhosari) Pune 411026, India Tel: +91-20-27102000
Russia	Mitsubishi Electric Europe B.V. Moscow Representative Office 52, 5th, 5, Kosmodemianskaya nab, RU-115054, Moscow, Russia Tel: +7-495-721-2070	Australia	Mitsubishi Electric Australia Pty. Ltd. 348 Victoria Road, Rydalmere, N.S.W. 2116, Australia Tel: +61-2-9684-7777
		South Africa	Circuit Breaker Industries Ltd. Private Bag 2016, ZA-1600 Isaando, South Africa Tel: +27-11-9282000

MITSUBISHI ELECTRIC CORPORATION
HEAD OFFICE: TOKYO BUILDING, 2-3 MARUNOUCHI, CHIYODA-KU, TOKYO 100-8310, JAPAN
HIMEJI WORKS: 840, CHIYODA CHO, HIMEJI, JAPAN

When exported from Japan, this manual does not require application to the Ministry of Economy, Trade and Industry for service transaction permission.

Specifications subject to change without notice.

Thank you very much for purchasing this product.

Please read this manual thoroughly before starting to use the product and handle the product properly.

User's Manual

MODEL	CL1XY8-DR1B2
MANUAL Number	JY997D04501E
Date	September 2008

SAFETY PRECAUTIONS

(Read these precautions before using)

Please read this manual carefully and pay special attention to safety in order to handle this product properly. Also pay careful attention to safety and handle the module properly.

These precautions apply only to Mitsubishi equipment. Refer to the user's manual of the CPU module to use for a description of the PLC system safety precautions.

These SAFETY PRECAUTIONS classify the safety precautions into two categories: "DANGER" and "CAUTION".

DANGER Procedures which may lead to a dangerous condition and cause death or serious injury if not carried out properly.

CAUTION Procedures which may lead to a dangerous condition and cause superficial to medium injury, or physical damage only, if not carried out properly.

Depending on circumstances, procedures indicated by CAUTION may also be linked to serious results.

In any case, it is important to follow the directions for usage. Store this manual in a safe place so that you can take it out and read it whenever necessary. Always forward it to the end user.

DESIGN PRECAUTIONS

DANGER

- Configure an interlock circuit in a sequence program so that the system operates on the safe side using the communication status information in the event the data link falls into a communication problem. Otherwise, erroneous output and malfunction may result in accidents.
- Remote input and output can not be switched ON or OFF when a problem occurs in the remote I/O modules. Therefore build an external monitoring circuit that will monitor any input signals that could cause a serious accident.

CAUTION

- Do not have control cables and communication cables bundled with or placed near by the main circuit and/or power cables. Wire those cables at least 100mm(3.94 inch) away from the main circuit and/or power cables. It may cause malfunction due to noise interference.
- Use the module and the flat cable dedicated to CC-Link/LT without applying any force on them.
- Otherwise, such cables may be broken or fail.

INSTALLATION PRECAUTIONS

CAUTION

- Use the module in an environment that meets the general specifications contained in this manual. Using this module in an environment outside the range of the general specifications could result in electric shock, fire, erroneous operation, and damage to or deterioration of the product.
- Do not directly touch the module's conductive parts. Doing so could cause malfunction or trouble in the module.
- Tighten the module securely using DIN rail or installation screws within the specified torque range.
- If the screws are too loose, the module may drop from its installation position, short circuit, or malfunction. If the screws are too tight, the screws may be damaged, which may cause the module to drop from its installation position or short circuit.
- Install the module on a flat surface.
- If the mounting surface has concave and/or convex, an excessive force may be applied on the module, and nonconformity may be caused.

WIRING PRECAUTIONS

DANGER

- Perform installation and wiring after disconnecting the power supply at all phases externally. If the power is not disconnected at all phases an electric shock or product damage may result.

CAUTION

- Terminal screws which are not to be used must be tightened always. Otherwise there will be a danger of short circuit against the bare solderless terminals.
- Perform correct wiring for the module according to the product's rated voltage and terminal arrangement. Connecting to a power supply different from rating or miss-wiring may cause fire, product failure or malfunction.
- Fix terminal screws securely within the regulated torque. Loose terminal screws may cause fire and/or malfunction.
- If the terminal screws are too tight, it may cause short circuit or erroneous operation due to damage of the screws.
- Make sure foreign objects do not get inside the module, such as dirt and wire chips. It may cause fire, product failure or malfunction.
- Attach a warning label (hazard symbol 417-IEC-5036) concerning the electric shock to the location.

STARTING AND MAINTENANCE PRECAUTIONS

DANGER

- Do not touch the terminals when the power is ON. It may cause an electric shock or malfunction.
- Perform cleaning the module or re-tightening of terminal screws after turning OFF the all external power supply for sure. Failure to do so may cause failure or malfunction of the modules.

CAUTION

- Do not disassemble or modify the module. Doing so may cause failure, malfunction, injury, or fire.
- The module case is made of resin; do not drop it or subject it to strong shock. A module damage may result.
- Make sure to switch all phases of the external power supply OFF before installing or removing the module to/from the panel. Failure to do so may cause failure or malfunction of the modules.

DISPOSAL PRECAUTIONS

DANGER

- When disposing of this product, treat it as industrial waste.

TRANSPORTATION AND MAINTENANCE PRECAUTIONS

CAUTION

- During transportation avoid any impact as the module is a precision instrument. Doing so could cause trouble in the module.
- If it is necessary to check the operation of module after transportation, in case of any impact damage.

Notification of CE marking

This notification does not guarantee that an entire mechanical module produced in accordance with the contents of the notification comply with the following standards. Compliance to EMC standards of the entire mechanical module should be checked by the user / manufacturer. Compliance to LVD standards of the entire mechanical module should be checked by the user / manufacturer.

Standards with which this product complies

Type : Programmable Controller (Open Type Equipment) Remote I/O module

Models : Products manufactured:

from November 1st, 2002 to April 30th, 2006 are compliant with EN61000-6-4 and EN61131-2:1994+A11:1996+A12:2000 after May 1st, 2006 are compliant with EN61131-2:2003

Electromagnetic Compatibility Standards (EMC)	Remark
EN61000-6-4:2001 Electromagnetic compatibility -Generic standards - Emission standard for Industrial environment	Compliance with all relevant aspects of the standard. (Radiated Emissions and Mains Terminal Voltage Emissions)
EN61131-2:1994/A11:1996/A12:2000 Programmable controllers -Equipment requirements and tests	Compliance with all relevant aspects of the standard. (RF Immunity, Fast transients, ESD and Damped oscillatory wave)
EN61131-2: 2003 Programmable controllers -Equipment requirements and tests	Compliance with all relevant aspects of the standard. (Radiated Emissions, Mains Terminal Voltage Emissions, RF immunity, Fast Transients, ESD, Surge, Voltage drops and interruptions, Conducted and Power magnetic fields)

Low Voltage Standards (LVD)	Remark
EN61131-2:1994/A11:1996/A12:2000 :2003 Programmable controllers -Equipment requirements and tests	The equipment has been assessed as a component for fitting in a suitable enclosure which meets the requirements of EN61131-2:1994 + A11:1996 + A12:2000, :2003

For more details please contact the local Mitsubishi Electric sales site.
 - Notes For compliance to EMC LVD regulation.
 It is necessary to install the CL1 series module in a shielded metal control panel.

1. Outline of Product

This product is a terminal block type composite I/O module connected to CC-Link/LT.
 This product has four input points (24V DC) and four output points (relay output).

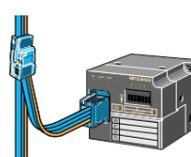

2. Name and Setting of Each Part and Terminal Arrangement

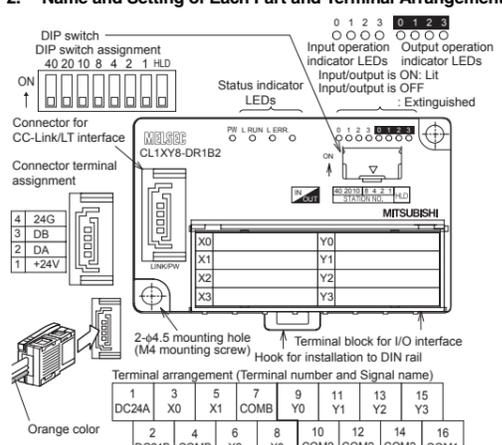

Name	Description
PW	ON while the power is supplied.
L RUN	ON while normal operation is executed.
Status indicator LEDs	ON: When a communication error or DIP switch setting error occurred Flickering at a constant interval: When the setting of the DIP switch was changed while the power was supplied (even while the LED is flickering, the operation continues. The new setting becomes valid when the power is turned OFF once, then ON again.) L ERR: Flickering at an intermittent interval: When a terminal resistor is not attached or when the module or a connection cable is affected by noise
I/O operation indicator LEDs	ON while the input or output is ON. Extinguished while the input or output is OFF.
Connector for CC-Link/LT interface	Connector for CC-Link/LT communication line/module power supply (24G/DB/DA+24V)
Terminal block for I/O interface	Terminal block to connect input signals, output signals, I/O power supply and load power supply

Name	Description						
Station number setting switches	Set the 10's digit of the station No. using "STATION NO. 10", "STATION NO. 20" and "STATION NO. 40". Set the 1's digit of the station No. using "STATION NO. 1", "STATION NO. 2", "STATION NO. 4" and "STATION NO. 8". Factory default = All bits are OFF. Make sure to set the station No. in the range from 1 to 64. If any station No. outside the range from 1 to 64 is set, it is regarded as an error and the L ERR. LED lights. Example: When setting the station No. to "32", set the DIP switch as follows. <table border="1"> <tr> <th>Station No.</th> <th>10's digit</th> <th>1's digit</th> </tr> <tr> <td>32</td> <td>OFF ON ON</td> <td>OFF OFF ON</td> </tr> </table>	Station No.	10's digit	1's digit	32	OFF ON ON	OFF OFF ON
Station No.	10's digit	1's digit					
32	OFF ON ON	OFF OFF ON					
Response time setting switch	HLD Holds the output (when an error has occurred). ON: Holds the output. OFF: Clears the output.						

3. Installation

The CL1XY8-DR1B2 can be installed to DIN rail or directly installed using mounting screws.
 Each installation procedure is described below.

3.1 Installation to DIN rail

Align the upper DIN rail installation groove in the module with the DIN rail 1), and press the module in that status 2).
 When removing the module, pull downward the hook for installation to DIN rail 3), then remove the module 4).

DIN rail mounting screw pitch

When installing the module to the DIN rail, tighten the mounting screws at the pitch of 200mm(7.87") or less.

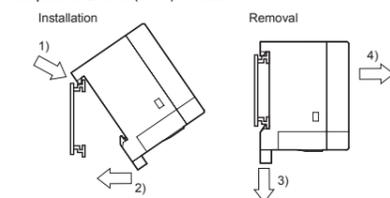

Applicable DIN rail TH35-7.5Fe and TH35-7.5Al

3.2 Direct installation

Screw-tighten the module by attaching M4 screws to the upper and lower mounting holes (two holes in all) provided in the module.
 Install the module so that the clearance of 1 to 2mm (0.04" to 0.08") is assured for each module.

Applicable screw M4 x 0.7mm(0.03") x 16mm(0.63") or more
 (Tightening torque range: 78 to 108 N-cm)

4. Wiring

4.1 External wiring

The input terminals of the CL1XY8-DR1B2 can be wired as positive common or negative common depending on the used sensor.

Positive common

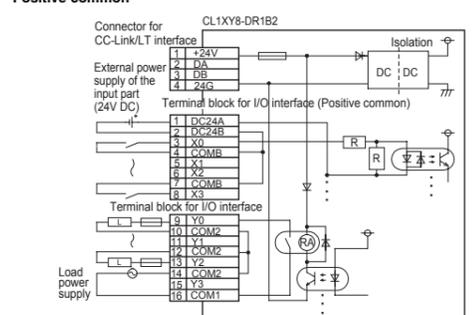

Negative common

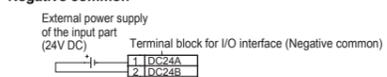

4.2 Connection to sensor

Positive common (NPN)

- When using a two-wire type sensor
- When using a three-wire type sensor

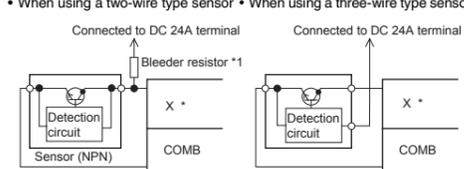

When using a three-wire type sensor (when using the power supply for sensor other than 24V DC)

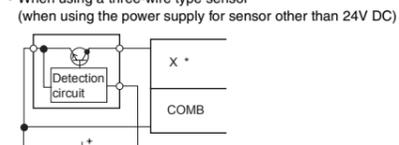

Negative common (PNP)

- When using a two-wire type sensor
- When using a three-wire type sensor

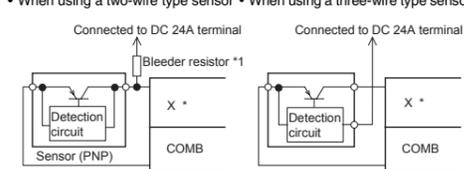

When using a three-wire type sensor (when using the power supply for sensor other than 24V DC)

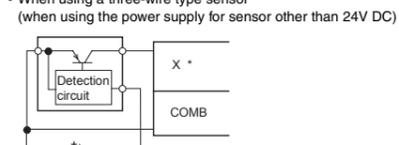

Replace * in the figure with the used input No.

Notes:

- *1 Bleeder resistor
 When connecting a two-wire type sensor or input equipment containing a parallel resistor, select a sensor or equipment whose leakage current is 1.7mA or less.
 If the leakage current is more than 1.7mA, connect a bleeder resistor obtained in the following calculation formula.
 Circuit image

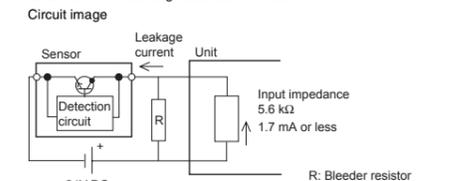

$R(k\Omega) < 1.7(mA) / \text{Leakage current}(mA) - 1.7(mA) \times 5.6(k\Omega)$

The power capacity W of the bleeder resistor R is as follows:

$$W = (\text{Input voltage})^2 / R$$

- Make sure that both the ON and OFF time of the input signal are 1.5ms or more.

4.3 Crimp-style terminal

For I/O wiring, use crimp-style terminals of the following dimensions.

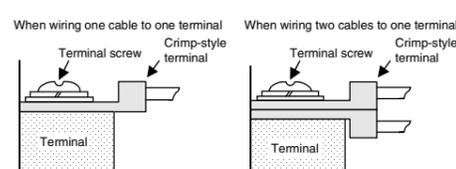

Applicable crimp-style terminal	<ul style="list-style-type: none"> RAV1.25-3 V1.25-3 (manufactured by JST Mfg. Co., Ltd.) 1.25-3 and TG1.25-3 (manufactured by NICHIFU Co., Ltd.)
Applicable wire size	0.3 to 1.25 mm ²

Use a crimp-style terminal in a status in which no force is applied on the cable.

4.4 Module terminal screw

Tighten the terminal screws (M3 screws) on the terminal block with a tightening torque of 42 to 58 N-cm.

5. Specifications

5.1 General specifications

Item	Specification
Operating ambient temperature	0 to 55°C (32 to 131°F)
Storage ambient temperature	-25 to 75°C (-13 to 167°F)
Operating ambient humidity	5 to 95%RH: Dew condensation shall not be considered.
Storage ambient humidity	5 to 95%RH: Dew condensation shall not be considered.
Vibration resistance	When intermittent vibration is present Frequency Acceleration Half amplitude 10 to 57Hz - 0.075mm 57 to 150Hz 9.8m/s ² - When continuous vibration is present Frequency Acceleration Half amplitude 10 to 57Hz - 0.035mm 57 to 150Hz 4.9m/s ² - Number of times of sweep 10 times in each of X, Y and Z directions (for 80 min)
Shock resistance	147 m/s ² , 3 times in each of X, Y and Z directions
Operating ambience	Corrosive gas shall not be present.
Operating altitude	2,000m(6561'8") or less (*1)
Installation location	Inside control panel (*2)
Overvoltage category	II or less (*3)
Pollution level	2 or less (*4)

- *1 The module cannot be used in an environment pressurized above the atmospheric pressure which can be generated around the altitude of 0 m. If the module is used in such an environment, it may fail.
- *2 The module can be used in an environment even outside the control panel as far as the requirements of the ambient operating temperature, the ambient operating humidity, etc. are satisfied.
- *3 This indicates the section of the power supply to which the equipment is assumed to be connected between the public electrical power distribution network and the machinery within premises. Category II applies to equipment for which electrical power is supplied from fixed facilities.
 The surge voltage withstand level for up to the rated voltage of 300V is 2500V.

*4 This index indicates the degree of conductive generating substances in the environment in which the module is used. The degree of contamination 2 indicates that contamination is caused by generation of only non-conductive substances.
 In this degree, however, temporary conduction may be caused by accidental condensation.

5.2 Input specifications

Item	Specification
Input method	DC input (External power supply of the input part)
Number of inputs	4 points
Isolation method	Isolation with photocoupler
Rated input voltage	24V DC
Rated input current	Approx. 4 mA
Operating voltage range	20.4 to 28.8V DC (24V DC -15% to +20%) Ripple ratio: Within 5%
Max. simultaneous ON input points	100% (at 24V DC)
ON voltage/ON current	19 V or more/3 mA or more
OFF voltage/OFF current	11 V or less/1.7 mA or less
Input resistance	5.6 kΩ
Response time	OFF→ON 1.5 ms or less (at 24V DC) ON→OFF 1.5 ms or less (at 24V DC)
Common wiring method	4 points/1 common (2 points) (terminal block two-wire type)

5.3 Output specifications

Item	Specification
Output method	Relay output
Number of outputs	4 points
Insulation method	Mechanical insulation
Rated load voltage	250V AC/30V DC or less
Max. load current	2A/point 4 A/1 common
Response time	OFF→ON Approx. 10ms or less ON→OFF Approx. 10ms or less
Common wiring method	4 points/1 common (3points) (terminal block two-wire type)
Internal protection for outputs	Internal protection circuit none Please connect the fuse in the connected load outside.

5.4 Performance specifications

Item	Specification
Module power supply	<ul style="list-style-type: none"> Voltage: 20.4 to 28.8V DC (24V DC -15% to +20%) Ripple ratio: Within 5% Current consumption: 70mA (when all points are ON) Initial current: 70mA Max. allowable momentary power failure period: PS1:1ms
Number of stations occupied	4-, 8- or 16-point mode: 1 station
Noise durability	DC type: 500 Vp-p AC type: 1,000 Vp-p Noise width: 1 μs Cycle: 25 to 60 Hz (by noise simulator)
Withstand voltage	AC type: 1,500V AC for 1 min DC type: 500V AC for 1 min
Isolation resistance	10 MΩ or more between primary area (external DC terminal) and secondary area (internal circuit) by 500V DC megger
Protection class	IP1X
I/O part connection method	Connection with terminal block
Module installation method	DIN rail installation, mounted by screws of type M4 x 0.7mm(0.03") x 16mm(0.63") or larger Can be installed in six directions
Mass (weight)	0.11kg (0.24lbs)
Contact life	<ul style="list-style-type: none"> 200V AC - 1.5 A, 240V AC - 1 A (COSφ = 0.7): 100,000 times or more 200V AC - 1 A, 240V AC - 0.1 A (COSφ = 0.35): 100,000 times or more 24V DC - 1 A, 100V DC - 0.1 A (L/R = 7 ms): 100,000 times or more

6. Outside Dimensions

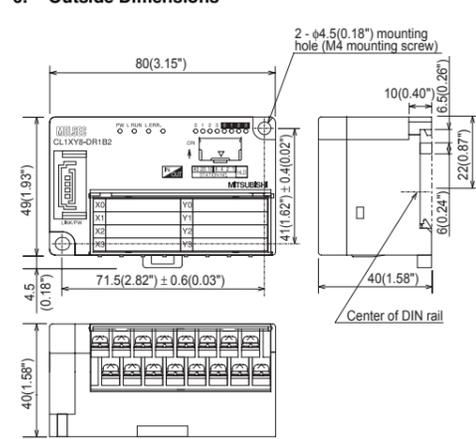

This manual confers no industrial property rights or any rights of any other kind, nor does it confer any patent licenses. Mitsubishi Electric Corporation cannot be held responsible for any problems involving industrial property rights which may occur as a result of using the contents noted in this manual.

Warranty

Mitsubishi will not be held liable for damage caused by factors found not to be the cause of Mitsubishi; machine damage or lost profits caused by faults in the Mitsubishi products; damage, secondary damage, accident compensation caused by special factors unpredictable by Mitsubishi; damages to products other than Mitsubishi products; and to other duties.

For safe use

- This product has been manufactured as a general-purpose part for general industries, and has not been designed or manufactured to be incorporated in a device or system used in purposes related to human life.
- Before using the product for special purposes such as nuclear power, electric power, aerospace, medicine or passenger movement vehicles, consult with Mitsubishi.
- This product has been manufactured under strict quality control. However when installing the product where major accidents or losses could occur if the product fails, install appropriate backup or failsafe functions in the system.

Country/Region	Sales office/Tel	Country/Region	Sales office/Tel
U.S.A.	Mitsubishi Electric Automation, Inc. 60 Corporate Woods Parkway, Vernon Hills, IL 60061 U.S.A. Tel: +1-847-478-2100 MELCO-TEC	Hong Kong	Mitsubishi Electric Automation (Hong Kong) Ltd. 10th Floor, Manulife Tower, 169 Electric Road, North Point, Hong Kong Tel: +852-2887-8870
Brazil	Av. Paulista 1439, cor.74, Bela Vista CEP: 01311-200 Sao Paulo-SP-Brazil Tel: +55-11-3285-1840	China	Mitsubishi Electric Automation (Shanghai) Ltd. 17F, ChungKing Financial Center, No. 288 West Nanjing Road, Shanghai, China 200001 Tel: +86-21-2322-3030
Germany	Mitsubishi Electric Europe B.V. German Branch Gothar Strasse 8, D-40880 Ratingen, Germany Tel: +49-2102-486-0	Taiwan	Satsuyo Enterprise Co., Ltd. 6F, No. 105 Wu Kung 3rd Rd., Wu-Ku Hsiang, Taipei Hsien, 248, Taiwan Tel: +886-2-2299-2469
U.K.	Mitsubishi Electric Europe B.V. UK Branch Travelers Lane, Hatfield, Hertfordshire, AL10 8BX, U.K. Tel: +44-1707-276100	Korea	Mitsubishi Electric Automation Korea Co., Ltd. 3F, 1480-6, Gyang-Dong, Gangseo-Gu, Seoul, 157-200, Korea Tel: +82-2-896-8552
Italy	VIALE COLLEONI 7-20041 Agrate Brianza (Milano), Italy Tel: +39-039-50551	Singapore	Mitsubishi Electric Asia Pte. Ltd. 307 Alexandra Road, Raffles Place, N.S.W. 2116, Australia Tel: +61-2-9884-7777
Spain	Mitsubishi Electric Europe B.V. Spanish Branch Ctra. de Rub 76-80-AC, 420, E-08190 Sant Cugat del Valles (Barcelona), Spain Tel: +34-93-556-3131	Thailand	Mitsubishi Electric Automation (Thailand) Co., Ltd. Bang-Chan Industrial Estate No.111, Soi Sertthai 51, T.Kanayao, A.Kanayao, Bangkok 10250 Tel: +66-2-517-1326
France	25, Boulevard des Bouettes, F-92741 Nanterre Cedex, France Tel: +33-1-55855555	India	Sapphire House E-3-J-Block MIDC Shrihari Pura 411026, India Tel: +91-20-2710200
Russia	Representative Office 52, bld. 5, Kosmodemianskaya nab., RU-115054, Moscow, Russia Tel: +7-495-721-2070	Australia	Mitsubishi Electric Australia Pty. Ltd. 348 Victoria Road, Rydalmere, N.S.W. 2116, Australia Tel: +61-2-9884-7777
		South Africa	Circuit Breaker Industries Ltd. Private Bag 2016, ZA-1600 Isando, South Africa Tel: +27-11-8282000

MITSUBISHI ELECTRIC CORPORATION
 HEAD OFFICE: TOKYO BUILDING, 2-7-3 MARUNOUCHI, CHYODOKU, TOKYO 100-8310, JAPAN
 HIMEJI WORKS: 8-0, CHYODOKU, HIMEJI, JAPAN

When exported from Japan, this manual does not require application to the Ministry of Economy, Trade and Industry for service translation permission.