

E5AR/ER Digital Controller DeviceNet Communications

User's Manual

Overview

Operating
Procedures

Parts, Installation,
and Wiring

Remote I/O
Communications

Explicit Message
Communications

Communications
Performance

Troubleshooting
and Maintenance

Appendix A

Appendix B

Appendix C

E5AR/ER
Digital Controller
DeviceNet Communications

User's Manual

Revised November 2010

Notice:

OMRON products are manufactured for use according to proper procedures by a qualified operator and only for the purposes described in this manual.

This manual describes the functions, performance, and application methods needed for optimum use of the E5AR/E5ER-DRT Digital Controllers.

Please observe the following items when using the E5AR/E5ER-DRT Digital Controllers.

- This product is designed for use by qualified personnel with a knowledge of electrical systems.
- Read this manual carefully and make sure you understand it well to ensure that you are using the E5AR/E5ER-DRT Digital Controllers correctly.
- Keep this manual in a safe location so that it is available for reference when required.

Visual Aids

The following headings appear in the left column of the manual to help you locate different types of information.

Note Indicates information of particular interest for efficient and convenient operation of the product.

1,2,3... 1. Indicates lists of one sort or another, such as procedures, checklists, etc.

Trademarks

- COMBICON is a registered trademark of Phoenix Contact.
- DeviceNet is a registered trademark of the Open DeviceNet Vendors Association, Inc.
- Other product names and company names that appear in this manual are the trademarks or registered trademarks of the respective companies.

© OMRON, 2004

All rights reserved. No part of this publication may be reproduced, stored in a retrieval system, or transmitted, in any form, or by any means, mechanical, electronic, photocopying, recording, or otherwise, without the prior written permission of OMRON.

No patent liability is assumed with respect to the use of the information contained herein. Moreover, because OMRON is constantly striving to improve its high-quality products, the information contained in this manual is subject to change without notice. Every precaution has been taken in the preparation of this manual. Nevertheless, OMRON assumes no responsibility for errors or omissions. Neither is any liability assumed for damages resulting from the use of the information contained in this publication.

Read and Understand this Manual

Please read and understand this manual before purchasing the product. Please consult your OMRON representative if you have any questions or comments.

Warranty and Limitations of Liability

WARRANTY

OMRON's exclusive warranty is that the products are free from defects in materials and workmanship for a period of one year (or other period if specified) from date of sale by OMRON.

OMRON MAKES NO WARRANTY OR REPRESENTATION, EXPRESS OR IMPLIED, REGARDING NON-INFRINGEMENT, MERCHANTABILITY, OR FITNESS FOR PARTICULAR PURPOSE OF THE PRODUCTS. ANY BUYER OR USER ACKNOWLEDGES THAT THE BUYER OR USER ALONE HAS DETERMINED THAT THE PRODUCTS WILL SUITABLY MEET THE REQUIREMENTS OF THEIR INTENDED USE. OMRON DISCLAIMS ALL OTHER WARRANTIES, EXPRESS OR IMPLIED.

LIMITATIONS OF LIABILITY

OMRON SHALL NOT BE RESPONSIBLE FOR SPECIAL, INDIRECT, OR CONSEQUENTIAL DAMAGES, LOSS OF PROFITS OR COMMERCIAL LOSS IN ANY WAY CONNECTED WITH THE PRODUCTS, WHETHER SUCH CLAIM IS BASED ON CONTRACT, WARRANTY, NEGLIGENCE, OR STRICT LIABILITY.

In no event shall the responsibility of OMRON for any act exceed the individual price of the product on which liability is asserted.

IN NO EVENT SHALL OMRON BE RESPONSIBLE FOR WARRANTY, REPAIR, OR OTHER CLAIMS REGARDING THE PRODUCTS UNLESS OMRON'S ANALYSIS CONFIRMS THAT THE PRODUCTS WERE PROPERLY HANDLED, STORED, INSTALLED, AND MAINTAINED AND NOT SUBJECT TO CONTAMINATION, ABUSE, MISUSE, OR INAPPROPRIATE MODIFICATION OR REPAIR.

Application Considerations

SUITABILITY FOR USE

OMRON shall not be responsible for conformity with any standards, codes, or regulations that apply to the combination of products in the customer's application or use of the products.

At the customer's request, OMRON will provide applicable third party certification documents identifying ratings and limitations of use that apply to the products. This information by itself is not sufficient for a complete determination of the suitability of the products in combination with the end product, machine, system, or other application or use.

The following are some examples of applications for which particular attention must be given. This is not intended to be an exhaustive list of all possible uses of the products, nor is it intended to imply that the uses listed may be suitable for the products.

- Outdoor use, uses involving potential chemical contamination or electrical interference, or conditions or uses not described in this manual.
- Nuclear energy control systems, combustion systems, railroad systems, aviation systems, medical equipment, amusement machines, vehicles, safety equipment, and installations subject to separate industry or government regulations.
- Systems, machines, and equipment that could present a risk to life or property.

Please know and observe all prohibitions of use applicable to the products.

NEVER USE THE PRODUCTS FOR AN APPLICATION INVOLVING SERIOUS RISK TO LIFE OR PROPERTY WITHOUT ENSURING THAT THE SYSTEM AS A WHOLE HAS BEEN DESIGNED TO ADDRESS THE RISKS, AND THAT THE OMRON PRODUCTS ARE PROPERLY RATED AND INSTALLED FOR THE INTENDED USE WITHIN THE OVERALL EQUIPMENT OR SYSTEM.

PROGRAMMABLE PRODUCTS

OMRON shall not be responsible for the user's programming of a programmable product, or any consequence thereof.

Disclaimers

CHANGE IN SPECIFICATIONS

Product specifications and accessories may be changed at any time based on improvements and other reasons.

It is our practice to change model numbers when published ratings or features are changed, or when significant construction changes are made. However, some specifications of the products may be changed without any notice. When in doubt, special model numbers may be assigned to fix or establish key specifications for your application on your request. Please consult with your OMRON representative at any time to confirm actual specifications of purchased products.

DIMENSIONS AND WEIGHTS

Dimensions and weights are nominal and are not to be used for manufacturing purposes, even when tolerances are shown.

PERFORMANCE DATA

Performance data given in this manual is provided as a guide for the user in determining suitability and does not constitute a warranty. It may represent the result of OMRON's test conditions, and the users must correlate it to actual application requirements. Actual performance is subject to the OMRON Warranty and Limitations of Liability.

ERRORS AND OMISSIONS

The information in this manual has been carefully checked and is believed to be accurate; however, no responsibility is assumed for clerical, typographical, or proofreading errors, or omissions.

Precautions for Safe Use

● Definition of Safety Notices and Information

The following notation is used in this manual to provide precautions required to ensure safe usage of the product.





The safety precautions that are provided are extremely important to safety. Always read and heed the information provided in all safety precautions.

The following notation is used.













 WARNING	Indicates a potentially hazardous situation which, if not avoided, will result in minor or moderate injury, or may result in serious injury or death. Additionally there may be significant property damage.
--	--

 CAUTION	Indicates a potentially hazardous situation which, if not avoided, may result in minor or moderate injury or in property damage.
--	--

● Symbols

Symbol		Meaning
Caution		General Caution Indicates non-specific general cautions, warnings, and dangers.
		Electrical Shock Caution Indicates possibility of electric shock under specific conditions.
Prohibition		General Prohibition Indicates non-specific general prohibitions.
Mandatory Caution		General Caution Indicates non-specific general cautions, warnings, and dangers.

● Precautions

 WARNING	
<p>Always provide protective circuits in the network. Without protective circuits, malfunctions may possibly result in accidents that cause serious injury or significant property damage. Provide double or triple safety measures in external control circuits, such as emergency stop circuits, interlock circuits, or limit circuits, to ensure safety in the system if an abnormality occurs due to malfunction of the product or another external factor affecting the product's operation.</p>	
 CAUTION	
<p>Do not attempt to disassemble, repair, or modify the product. Doing so may occasionally result in minor injury due to electric shock.</p>	
<p>Do not touch the terminals, or electronic components or patterns on the PCB within 1 minute after turning OFF the power. Doing so may occasionally result in minor injury due to electric shock.</p>	
<p>Do not allow pieces of metal, wire clippings, or fine metallic shavings or filings from installation to enter the product. Doing so may occasionally result in electric shock, fire, or malfunction.</p>	
<p>Do not use the product in locations where flammable or explosive gases are present. Doing so may occasionally result in minor or moderate explosion, causing minor or moderate injury, or property damage.</p>	
<p>Do not attempt to disassemble, repair, or modify the product. Doing so may occasionally result in minor or moderate injury due to electric shock.</p>	
<p>Tighten the screws on the terminal block and the connector locking screws securely using a tightening torque within the following ranges. Loose screws may occasionally cause fire, resulting in minor or moderate injury, or damage to the equipment. Terminal block screws: 0.40 to 0.56 N·m Connector locking screws: 0.25 to 0.30 N·m</p>	
<p>Perform correct setting of the product according to the application. Failure to do so may occasionally cause unexpected operation, resulting in minor or moderate injury, or damage to the equipment.</p>	
<p>Ensure safety in the event of product failure by taking safety measures, such as installing a separate overheating prevention alarm system. Product failure may occasionally prevent control, or operation of alarm outputs, resulting in damage to the connected facilities and equipment.</p>	
<p>Do not use the equipment for measurements within Measurement Categories II, III, or IV (according to IEC61010-1). Doing so may occasionally cause unexpected operation, resulting in minor or moderate injury, or damage to the equipment. Use the equipment for measurements only within the Measurement Category for which the product is designed.</p>	
<p>The service life of the output relays depends on the switching capacity and switching conditions. Consider the actual application conditions and use the product within the rated load and electrical service life. Using the product beyond its service life may occasionally result in contact welding or burning.</p>	

 **CAUTION**

Make sure that the product will not be adversely affected if the DeviceNet cycle time is lengthened as a result of changing the program with online editing. Extending the cycle time may cause unexpected operation, occasionally resulting in minor or moderate injury, or damage to the equipment.



Before transferring programs to other nodes or changing I/O memory of other nodes, check the nodes to confirm safety. Changing the program or I/O memory of other nodes may occasionally cause unexpected operation, resulting in minor or moderate injury, or damage to the equipment.



Precautions for Safe Use

1. Use and store the product within the specified ambient temperature and humidity ranges. If several products are mounted side-by-side or arranged in a vertical line, the heat dissipation will cause the internal temperature of the products to rise, shortening the service life. If necessary, cool the products using a fan or other cooling method.
2. Provide sufficient space around the product for heat dissipation. Do not block the vents on the product.
3. Use the product within the noted supply voltage and rated load.
4. Be sure to confirm the name and polarity for each terminal before wiring the terminal block and connectors.
5. Do not connect anything to unused terminals.
6. Use the specified size of crimp terminals (M3, width: 5.8 mm max.) for wiring the terminal block.
7. To connect bare wires to the terminal block, use AWG22 to AWG14 (cross-sectional area: 0.326 to 2.081 mm²) to wire the power supply terminals and AWG28 to AWG16 (cross-sectional area: 0.081 to 1.309 mm²) for other terminals. (Length of exposed wire: 6 to 8 mm)
8. Ensure that the rated voltage is achieved no longer than 2 s after turning the power ON.
9. Turn OFF the power first before drawing out the product. Never touch the terminals or the electronic components, or subject them to physical shock. When inserting the product, do not allow the electronic components to contact the case.
10. Do not remove the inner circuit board.
11. Output turns OFF when shifting to the initial setting level in certain modes. Take this into consideration when setting up the control system.
12. Allow the product to warm up for at least 30 minutes after the power is turned ON.
13. Install surge absorbers or noise filters in devices near the product that generate noise (in particular, devices with an inductance component, such as motors, transformers, solenoids, and magnetic coils). If a noise filter is used for the power supply, check the voltage and current, and install the noise filter as close as possible to the product. Separate the product as far as possible from devices generating strong high-frequency noise (e.g., high-frequency welders and high-frequency sewing machines) or surges. Do not tie noise filter input/output wires together.
14. Keep the wiring for the product's terminal block and connector separate from high-voltage, high-current power lines to prevent inductive noise. Do not run the wiring parallel to or in the same cable as power lines. The influence of noise can also be reduced by using separate wiring ducts or shield lines.
15. Install an external switch or circuit breaker and label them clearly so that the operator can quickly turn OFF the power.

16. Do not use the product in the following locations.
 - Locations where dust or corrosive gases (in particular, sulfuric or ammonia gas) are present.
 - Locations where icing or condensation may occur.
 - Locations exposed to direct sunlight.
 - Locations subject to excessive shock or vibration.
 - Locations where the product may come into contact with water or oil.
 - Locations subject to direct radiant heat from heating equipment.
 - Locations subject to extreme temperature changes.
17. Cleaning: Do not use thinners. Use commercially available alcohol.
18. Use the specified cables for the communications lines and stay within the specified DeviceNet communications distances.
19. Do not pull the DeviceNet communications cables with excessive force or bend them past their natural bending radius.
20. Do not connect or remove connectors while the DeviceNet power is being supplied. Doing so will cause product failure or malfunction.

EC Directives

- EMC Directives

Concepts

EMC Directives

OMRON devices that comply with EC Directives also conform to the related EMC standards so that they can be more easily built into other devices or the overall machine. The actual products have been checked for conformity to EMC standards. Whether the products conform to the standards in the system used by the customer, however, must be checked by the customer.

EMC-related performance of the OMRON devices that comply with EC Directives will vary depending on the configuration, wiring, and other conditions of the equipment or control panel on which the OMRON devices are installed. The customer must, therefore, perform the final check to confirm that devices and the overall machine conform to EMC standards.

Conformance to EC Directives

The E5AR/E5ER-DRT Digital Controllers comply with EC Directives. To ensure that the machine or device in which the Unit is used complies with EC Directives, the Unit must be installed as follows:

- 1,2,3...**
1. You must use reinforced insulation or double insulation for the DC power supplies used for the communications power supply, internal power supply, and I/O power supplies.
 2. Units complying with EC Directives also conform to the Common Emission Standard (EN61326). Radiated emission characteristics (10-m regulations) may vary depending on the configuration of the control panel used, other devices connected to the control panel, wiring, and other conditions. You must therefore confirm that the overall machine or equipment complies with EC Directives.

The following example shows one means of reducing noise.

- 1,2,3...**
1. Noise from the communications cable can be reduced by installing a ferrite core on the communications cable within 10 cm of the DeviceNet Master Unit.

Ferrite Core (Data Line Filter): 0443-164151 (manufactured by Fair-Rite Products Co., Ltd.)

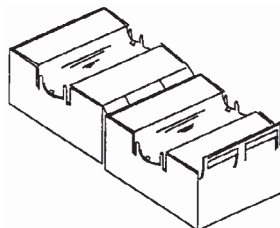

Impedance specifications	
25 MHz	105 Ω
100 MHz	190 Ω

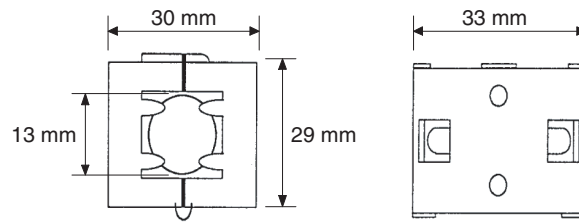

2. Wire the control panel with as thick and short electric lines as possible and ground to 100 Ω min.
3. Keep DeviceNet communications cables as short as possible and ground to 100 Ω min.

TABLE OF CONTENTS

SECTION 1

Overview	1-1
1-1 Features	1-2
1-2 Specifications	1-5

SECTION 2

Operating Procedures	2-1
2-1 Introduction	2-2
2-2 Functions Supported Only by the E5AR/ER-DRT	2-4

SECTION 3

Parts, Installation, and Wiring	3-1
3-1 Part Names and Functions	3-2
3-2 How to Use the Terminals	3-6
3-3 DeviceNet Communications Cables Wiring	3-15

SECTION 4

Remote I/O Communications	4-1
4-1 Overview	4-2
4-2 I/O Allocation	4-2
4-3 Ladder Programming Examples	4-15

SECTION 5

Explicit Message Communications	5-1
5-1 Overview of Explicit Message Communications	5-2
5-2 Sending CompoWay/F Commands to the Digital Controller	5-4
5-3 Explicit Messages Specific to DeviceNet-compatible Digital Controllers	5-6

SECTION 6

Communications Performance	6-1
6-1 Remote I/O Communications Performance	6-2
6-2 Message Communications Performance	6-6

SECTION 7

Troubleshooting and Maintenance	7-1
7-1 Indicators and Error Processing	7-2
7-2 Maintenance	7-3

TABLE OF CONTENTS

Appendices

A	Detailed DeviceNet Specifications	A-1
B	Mounted Objects	B-1
C	DeviceNet Connection Hardware	C-1

Glossary	1-1
-----------------------	------------

Index.....	1-1
-------------------	------------

Revision History	1-1
-------------------------------	------------

About this Manual:

This manual describes the installation and operation of the E5AR/E5ER-DRT Digital Controllers and includes the sections described below.

Please read this manual carefully and be sure you understand the information provided before attempting to install or operate an E5AR/E5ER-DRT Digital Controller. Be sure to read the precautions provided in the following section.

Precautions provides general precautions for using E5AR/E5ER-DRT Digital Controllers and related devices.

Section 1 introduces the features and specifications of E5AR/E5ER-DRT Digital Controllers.

Section 2 outlines the basic operating procedures for the E5AR/E5ER-DRT Digital Controllers.

Section 3 describes the methods used to install and wire E5AR/E5ER-DRT Digital Controllers.

Section 4 describes the input (IN) areas and output (OUT) areas that E5AR-DRT and E5ER-DRT Digital Controllers can use for remote I/O communications. The methods to allocate data for master communications are also described using sample programming.

Section 5 describes how to send explicit messages to the E5AR/E5ER-DRT Digital Controller, including how to send CompoWay/F commands using explicit messages.

Section 6 provides information on the time required for a complete communications cycle, for an output response to be made to an input, to start the system, and to send messages.

Section 7 describes error processing, periodic maintenance operations, and troubleshooting procedures needed to keep the DeviceNet Network operating properly. Details on resetting replaced Controllers are also provided. Read through the error processing procedures in both this manual and the operation manual for the DeviceNet master being used before operation so that operating errors can be identified and corrected more quickly.

The **Appendices** provide the device profile of the DeviceNet Communications Unit, additional information on DeviceNet, a list of hardware products for DeviceNet, and the DeviceNet objects that are mounted.

 **WARNING** Failure to read and understand the information provided in this manual may result in personal injury or death, damage to the product, or product failure. Please read each section in its entirety and be sure you understand the information provided in the section and related sections before attempting any of the procedures or operations given.

Related Manuals:

The manuals related to the E5AR-DRT/E5ER-DRT are configured as shown in the following tables. Refer to these manuals as required.

E5AR/E5ER Manuals

Cat. No.	Models	Name	Application	Contents
H124 (this manual)	E5AR-DRT E5ER-DRT	Digital Controller DeviceNet Communications User's Manual	To learn about the basic specifications of a DeviceNet Communications Unit, including an overview, designing, and maintenance	This manual provides the following information on the DeviceNet Communications Unit. <ul style="list-style-type: none"> • Overview and features • System configuration • Installation and wiring • Troubleshooting
Z182	E5AR E5ER	Digital Controller User's Manual	To learn about the basic specifications of an E5AR/E5ER Digital Controller, including an overview, designing, installation, and maintenance	This manual provides the following information on the E5AR/E5ER Digital Controllers. <ul style="list-style-type: none"> • Overview and features • System configuration • Installation and wiring • Troubleshooting
--- (Available only as online help.)	EST2-2C-MV□	CX-Thermo Ver. □ (online help only)	To learn how to operate the CX-Thermo	This manual describes how to set parameters and adjust devices (i.e., components such as Temperature Controllers) using the CX-Thermo.

DeviceNet Master Manual

Cat. No.	Models	Name	Application	Contents
W267	CS1W-DRM21(-V1) CJ1W-DRM21 CVM1-DRM21-V1 C200HW-DRM21-V1	DeviceNet User's Manual	To learn the communications specifications and wiring methods for DeviceNet communications networks	This manual describes the network configuration, connection types, and other information on DeviceNet networks. It also provides information on the installation and specifications of cables, connectors, and other connection devices used in the network along with the methods used to supply communications power.
W379	CVM1-DRM21 CVM1-DRM21-V1 C200HW-DRM21 C200HW-DRM21-V1	CVM1/CV DeviceNet Master Unit and C2000HX/HG/HE and C200HS DeviceNet Master Unit Operation Manual	To learn about CVM1/CV DeviceNet Master Units and C2000HX/HG/HE and C200HS DeviceNet Master Units	This manual provides information on the specifications, functions, and application procedures of the CVM1/CV DeviceNet Master Units and C2000HX/HG/HE and C200HS DeviceNet Master Units.
W380	CS1W-DRM21(-V1) CJ1W-DRM21	CS/CJ-series DeviceNet Unit Operation Manual	To learn about the CS/CJ-series DeviceNet Units	This manual provides information on the specifications, functions, and application procedures of the CS/CJ-series DeviceNet Master Units. (The CS/CJ-series DeviceNet Master Units can be used simultaneously as both masters and slaves.)

SECTION 1

Overview

This section introduces the features and specifications of E5AR/ER-DRT Digital Controllers.

1-1	Features	1-2
1-1-1	Outline	1-2
1-1-2	Communications Connection Example	1-2
1-1-3	Using DeviceNet	1-2
1-1-4	Default Communications Settings	1-3
1-1-5	Data Allocation	1-3
1-1-6	Remote I/O Communications	1-3
1-2	Specifications	1-5
1-2-1	DeviceNet Communications Specifications	1-5
1-2-2	DeviceNet General Specifications	1-5

1-1 Features

The E5AR-DRT and E5ER-DRT (E5AR/ER-DRT) are Digital Controllers that use DeviceNet for communications.

1-1-1 Outline

The E5AR/ER-DRT Digital Controllers are slaves that connect to the DeviceNet open field network. DeviceNet communications enable controlling operation, collecting measurement data, and writing settings from a host computer or PLC. The E5AR/ER-DRT support both remote I/O communications and explicit message communications.

Remote I/O communications allow the master and the E5AR/ER-DRT to automatically share data via high-speed I/O without any special programming of the master. Remote I/O communications are particularly suited to operation control, error warnings, and monitoring applications.

Explicit messages use a communications protocol for sending commands and receiving responses. The main application for explicit message communications is for changing E5AR/ER-DRT settings data.

1-1-2 Communications Connection Example

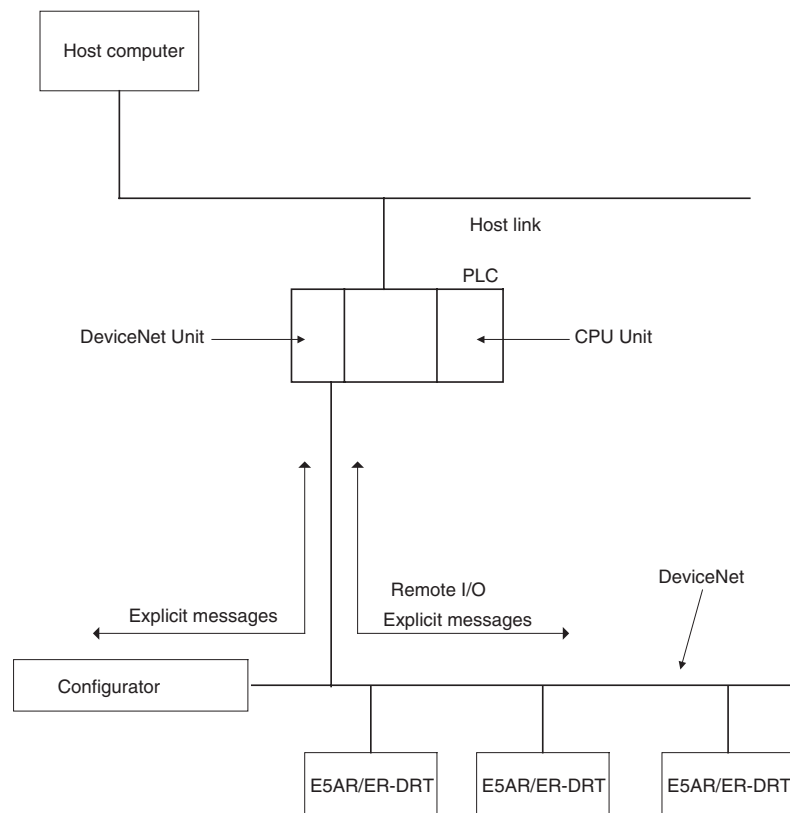

1-1-3 Using DeviceNet

Remote I/O Communications

The master and E5AR/ER-DRT Digital Controllers can share I/O by using remote I/O communications. Data in the E5AR/ER-DRT Digital Controllers, such as process values (PVs) and set points (SPs), can be allocated for communications with the master to enable sending and receiving the allocated data via remote I/O communications without requiring special programming.

Explicit Message Communications

- User-set Data Allocations with a Configurator
The specific data required for communications with the master can be allocated by using I/O allocations from the DeviceNet Configurator.
- By sending commands from a PLC, various operations can be performed, including reading/writing specific monitor values and parameters, such as reading process values or writing set points, and performing operations using operation commands. CompoWay/F communications commands can also be executed using explicit message communications.

Automatically Detects Baud Rate

- Previously, the baud rate had to be set for each slave, but the E5AR/ER-DRT Digital Controllers automatically detect and match the baud rate of the master, so this setting is not required. (If the master's baud rate is changed, turn OFF the communications power supply to the Digital Controller and then turn it ON again.)

1-1-4 Default Communications Settings

The default settings required for communications when E5AR/ER-DRT are used as DeviceNet slaves are listed in the following diagram.

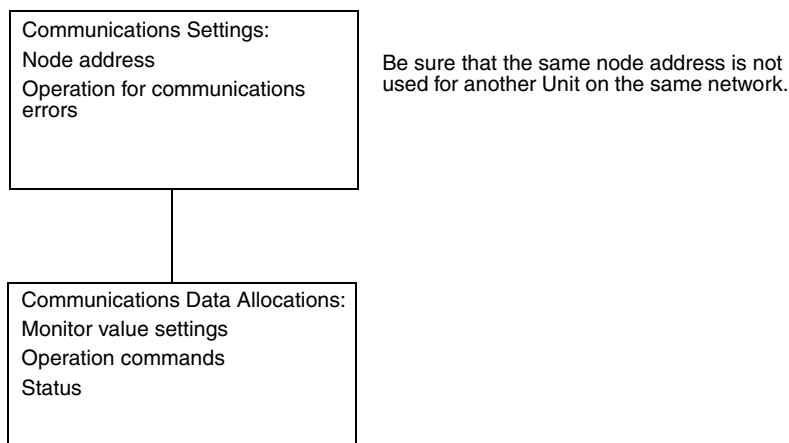

Refer to the *DeviceNet Operation Manual* (Cat. No. W267) for information such as the order for turning ON power to the master and slaves and master I/O tables.

1-1-5 Data Allocation

E5AR/ER-DRT communications data must be allocated for the IN and OUT Areas for remote I/O communications. Up to 100 words each can be allocated for the IN and OUT Areas. The data for each word is allocated using the parameters communications write data allocations 1 to 100 and communications read data allocations 1 to 100.

Unused words can be specified to reserve space according to data types or to otherwise reduce the number of words.

Refer to 4-2 *I/O Allocation* on page 4-2 for details on allocation methods.

1-1-6 Remote I/O Communications

Read/write table data is automatically read and written when communications start. The Communications Write setting must be set to ON to write data from the master to the E5AR/ER-DRT. Data will not be written to the Digital Controller if the Communications Write setting is OFF. The following diagram shows communications with the default data allocation parameters.

Note The Communications Write setting is ON by default.

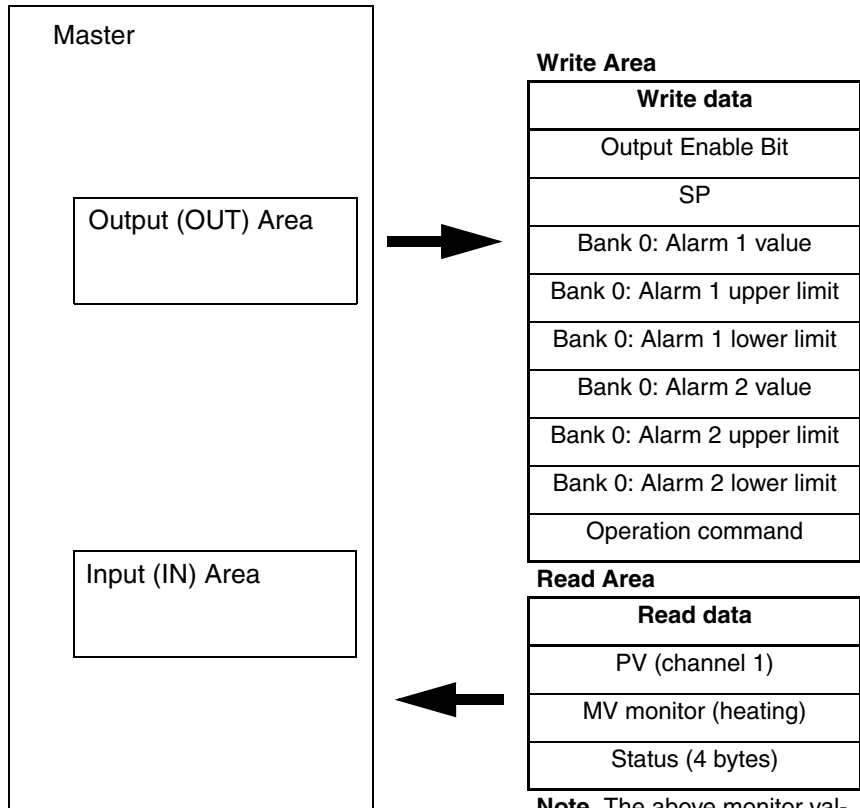

Note The above monitor values and setting data are all for channel 1.

1-2 Specifications

1-2-1 DeviceNet Communications Specifications

Item		Specifications			
Communications protocol		Conforms to DeviceNet			
Communications functions	Remote I/O communications	<ul style="list-style-type: none"> • Master-slave connections (polling, bit-strobe, COS, or cyclic) • Conform to DeviceNet specifications. 			
	I/O allocations	<ul style="list-style-type: none"> • Can allocate any I/O data from the Configurator. • Can allocate any data, such parameters specific to the DeviceNet and the Digital Controller variable area. • Up to 2 blocks for the IN Area, up to a total of 100 words (See note 1.) • One block for the OUT Area, up to 100 words (The first word is always allocated to Output Enable Bits.) (See note 2.) 			
	Message communications	<ul style="list-style-type: none"> • Explicit message communications • CompoWay/F communications commands can be sent (commands are sent in explicit message format). 			
Connection format		Combination of multidrop and T-branch connections (for trunk and drop lines)			
Baud rate		DeviceNet: 500, 250, or 125 kbps, or automatic detection of master baud rate			
Communications media		Special 5-wire cable (2 signal lines, 2 power lines, and 1 shield line)			
Communications distance	Baud rate	Network length	Drop line length	Total drop line length	
	500 kbps	100 m max. (100 m max.)	6 m max.	39 m max.	
	250 kbps	100 m max. (250 m max.)	6 m max.	78 m max.	
	125 kbps	100 m max. (500 m max.)	6 m max.	156 m max.	
		The values in parentheses apply when Thick Cables are used.			
Communications power supply		11 to 25 VDC			
Maximum number of nodes that can be connected		64 (includes Configurator when used)			
Maximum number of slaves that can be connected		63			
Error control		CRC error detection			
Power supply		Power supplied from DeviceNet communications connector			

- Note**
- (1) The IN Area can be divided into two blocks only when a CS/CJ-series DeviceNet Unit is used as the master. (The connection type can also be selected.) If a CVM1, CV, or C200HX/HG/HE DeviceNet Master Unit is used as the master, the IN Area must be in 1 block with a maximum 100 words (200 bytes). (Polling connection only.)
 - (2) If a CVM1, CV, or C200HX/HG/HE DeviceNet Master Unit used, only up to 32 words can be allocated per node.

1-2-2 DeviceNet General Specifications

Item	Specifications
Supply voltage	DeviceNet power supply: 24 VDC (internal circuit)
Allowable voltage range	DeviceNet power supply: 11 to 25 VDC
Current consumption	DeviceNet power supply: 50 mA max. (24 VDC)
Vibration resistance	Vibration: 10 to 55 Hz Acceleration: 20 m/s ²
Shock resistance	150 m/s ² max. 3 times each in 3 axes, 6 directions
Dielectric strength	2,000 VAC
Insulation resistance	20 MΩ min. (at 500 VDC)

Item	Specifications
Ambient temperature	–10 to 55°C (with no condensation or icing) –10 to 50°C (for 3-year warranty)
Ambient humidity	25% to 85%
Storage temperature	–25 to 65°C (with no condensation or icing)
Enclosure rating	IP00 (connector)
Memory protection	EEPROM (100,000 write operations)
Weight	Connector cover: Approx. 2 g DeviceNet connector: Approx. 10 g

SECTION 2

Operating Procedures

This section outlines the basic operating procedures for the E5AR/ER-DRT Digital Controllers.

- 2-1 Introduction 2-2
 - 2-1-1 Setup Procedure 2-2
 - 2-1-2 Startup Procedure 2-2
 - 2-1-3 Setting Node Addresses 2-3
- 2-2 Functions Supported Only by the E5AR/ER-DRT 2-4
 - 2-2-1 Network Power Monitor Function 2-4
 - 2-2-2 Accumulated ON (RUN) Time Monitor Function 2-5
 - 2-2-3 Operation for Communications Errors 2-5

2-1 Introduction

Use the procedures in the following sections to prepare the E5AR/ER-DRT Digital Controllers for use. Refer to the following reference pages/sections provided for detailed information on each step.

2-1-1 Setup Procedure

Step	Item	Details	Reference
1	Mount the Digital Controller.	Mount the Digital Controller to the panel.	page 3-4
2	Wire the Digital Controller.	Wire the temperature inputs and control outputs to the Digital Controller terminals. Note Do not turn ON the power supply to the peripheral devices at this time.	page 3-10
3	Turn ON the power to the Digital Controller.	Turn ON the power connected to the Digital Controller. Note The Digital Controller will start.	page 3-10
4	Set the DeviceNet node address.	Set the DeviceNet node address (0 to 63) for the Digital Controller on the front panel. Set a unique node address for each slave connected to the same master.	page 2-3
5	Turn OFF the power to the Digital Controller.	Turn OFF the power connected to the Digital Controller.	---

2-1-2 Startup Procedure

Prepare the master, DeviceNet communications power supply, and Configurator that will be used in the system. Use the Configurator to allocate Digital Controller data in the IN and OUT Areas. Refer to the *DeviceNet Operation Manual (W267)* for information on related connection devices.

Note Up to 100 words each can be allocated in the IN Area and OUT Area for remote I/O communications. To read and write larger amounts of data, use explicit messages. Use explicit message communications also for reading and writing data only when required.

Step	Item	Details	Reference
6	Connect the DeviceNet communications connector.	Connect the DeviceNet communications connector. Note Do not turn ON the communications power supply at this time. This power supply is also used as the internal circuit power supply for DeviceNet communications.	page 3-15
7	Turn ON the power to the Digital Controller.	Turn ON the power connected to the Digital Controller. Note The Digital Controller will start.	page 3-10
8	Turn ON the DeviceNet communications power (V+, V-).	Turn ON the communications power supply to DeviceNet.* Note The DeviceNet communications will start.	---
9	Check the MS/NS indicators	Check that the status of the MS and NS indicators is as follows: MS: Operating normally when lit green. NS: Operating normally when lit green. (DeviceNet online or communications connected.)	page 3-3

* When changing the baud rate of the master after starting the E5AR-DRT/E5ER-DRT Digital Controller, turn ON the communications power supply of the Digital Controller again, and restart the Digital Controller. When setting the Configurator only, without a master, the baud rate of the Configurator will be automatically detected.

Step	Item	Details	Reference
10	Operate from the Configurator.	Set from the Configurator when changing data allocated in the IN and OUT Areas from the default values. To split the IN Area used by the E5AR/ER-DRT into two areas, select E5AR/ER-DRT in the master's Edit Device Parameters Window and set the connection in the detailed settings. When the IN Area is split into two areas, for example, operating parameters, such as set points and process values, can be allocated in IN Area 1, and status values can be allocated in IN Area 2. For example, IN Area 1 can be allocated in the DM Area and IN Area 2 can be allocated in the CIO Area.	SECTION 4 <i>Remote I/O Communications</i>
11	Start remote I/O communications.	Enable the master's scan list and change the PLC to RUN Mode. Remote I/O communications will start, and the contents of the IN and OUT Areas in the master and E5AR/ER-DRT Digital Controller will be synchronized.	---
12	Use explicit message communications.	Send explicit messages from the master. Explicit messages can be used to perform control and monitoring that cannot be achieved using the IN and OUT Areas alone, by sending explicit messages to the E5AR/ER-DRT Digital Controller.	SECTION 5 <i>Explicit Message Communications</i>

Observe the following precautions when editing device parameters using the Configurator.

- It is recommended that device default values are uploaded before the parameters are edited because the EDS parameter defaults and the device defaults are different.
- If "Unit No." (communications unit number) is displayed in the Communications Setting parameter group, set the "Unit No." to the node address.
- If "Input 2 Type" is displayed in the Input Initial Setting parameter group for the E5AR-□□□B-DRT, E5ER-□□□B-DRT, E5AR-□□□F-DRT, or E5ER-□□□F-DRT, set the "Input 2 Type" to 15. The default value may not be downloaded.
- Related settings are not initialized when data is downloaded from the Configurator. Refer to the *Appendix* in the *E5AR/E5ER Digital Controller User's Manual* (Cat. No. H124) for information on how to correctly set related data.
- The automatic selection range upper limit (DV) can be set from the front panel or it can be set using the automatic selection range upper limit (PV) parameter (PID*AUT(PV)). When using the automatic selection range upper limit (PV) parameter, set the value obtained from the following equation:
Automatic selection range upper limit (PV) = Automatic selection range upper limit (DV) + Sensor setting range lower limit

2-1-3 Setting Node Addresses

DeviceNet node addresses are set in the communications setting level. Set the node addresses on the front panel of the E5AR/ER-DRT.

- The node address will be 0 if an address between 64 and 99 is set.

Setting Operation

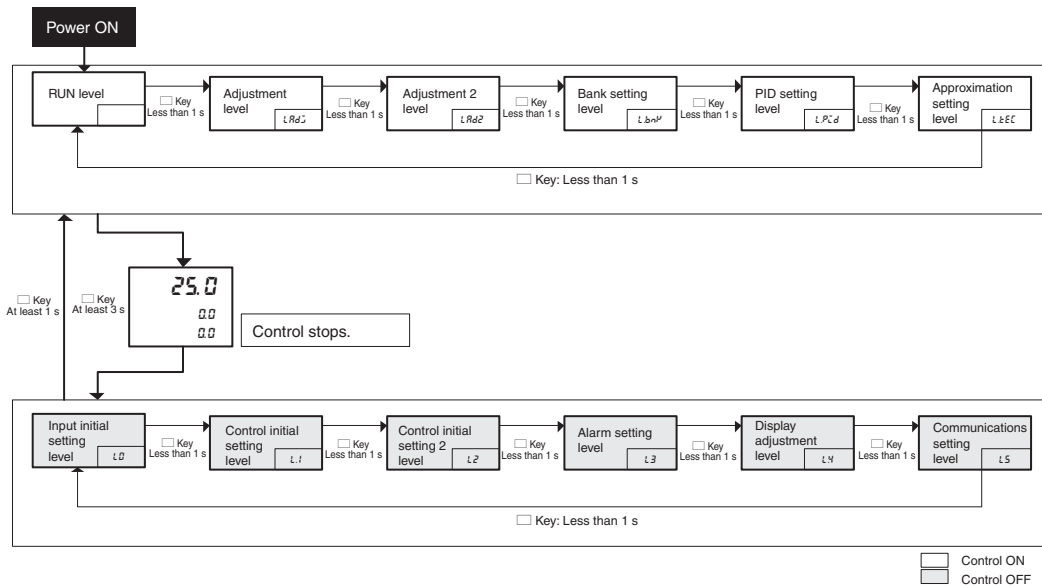

Setting Parameters

Press the LEVEL Key for at least 3 s to move from the RUN level to the input initial setting level.

Press the LEVEL Key several times to move from the input initial setting level to the communications setting level.

The communications unit number (U-nā) (DeviceNet node address) will be displayed.

Press the UP and DOWN Keys to change the setting.

The number of words allocated will depend on the E5AR/ER-DRT communications data allocations. The following points are important when setting node addresses or allocating I/O memory.

- Do not allocate the same words to other slaves.
- Make sure the I/O area does not exceed the valid range.

2-2 Functions Supported Only by the E5AR/ER-DRT

A Configurator is used to make settings for the network power monitor function, accumulated ON (RUN) time monitor function, and control at error function.

2-2-1 Network Power Monitor Function

The E5AR/ER-DRT has a network power monitor function that turns ON the Communications Power Voltage Monitor Error Flag in the General Status when the communications power voltage drops below the set monitor value. The monitor value for the network power voltage is set using the Configurator and is found in the General Setting parameter group.

2-2-2 Accumulated ON (RUN) Time Monitor Function

The E5AR/ER-DRT has accumulated ON (RUN) time monitor functions which record internally the total time communications power is supplied or the accumulated RUN (control) time. The Unit Maintenance Flag in the General Status will turn ON if the accumulated time exceeds a set monitor value.

The Detection Mode and Detection Time are set using a Configurator and are found in the General Setting parameter group.

The ON (RUN) time monitor function can be used as a guide for replacing the E5AR/ER-DRT Digital Controller.

Measurement unit: 0.1 h

Measurement range: 0 to 429496729.5 h (Stored data: 00000000 to FFFFFFFF hex).

- Note**
- (1) The ON or RUN time is held even when the power is turned OFF.
 - (2) Both the ON and RUN time monitor functions cannot be used at the same time for one word.
 - (3) The accumulated time will not be measured if communications power is not supplied to the E5AR/ER-DRT.
 - (4) The E5AR/ER-DRT Digital Controller checks the ON/RUN status of the target channel approximately every 0.1 h (6 min.).

2-2-3 Operation for Communications Errors

The “Control at Error” specifies the operation to be performed if a DeviceNet communications error occurs. The Control at Error setting is made using the Configurator and is found in the Communications Setting parameter group.

Setting range	Unit	Default
Continue	---	Continue
Stop		

SECTION 3

Parts, Installation, and Wiring

This section describes the methods used to install and wire E5AR/E5ER-DRT Digital Controllers.

3-1	Part Names and Functions	3-2
3-1-1	Part Names	3-2
3-1-2	External Dimensions	3-2
3-1-3	MS and NS Indicators	3-3
3-1-4	Installation	3-4
3-2	How to Use the Terminals	3-6
3-2-1	Connections	3-6
3-2-2	Precautions when Wiring	3-9
3-2-3	Wiring	3-10
3-3	DeviceNet Communications Cables Wiring	3-15
3-3-1	Preparing DeviceNet Communications Cables	3-15
3-3-2	Attaching the DeviceNet Communications Unit Connector	3-16
3-3-3	Insulation Blocks	3-18

3-1 Part Names and Functions

3-1-1 Part Names

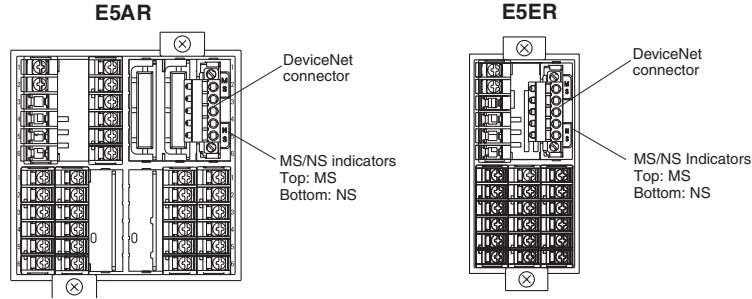

DeviceNet Communications Connector





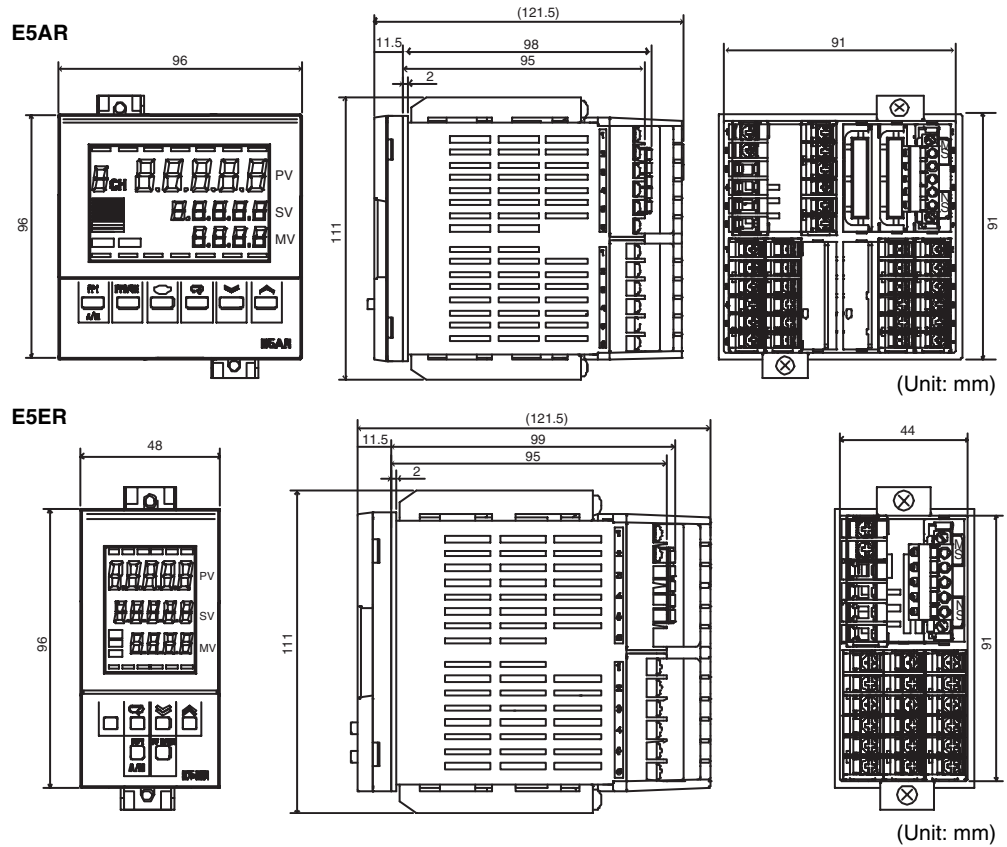



The DeviceNet communications connector is used to connect the communications cable to the DeviceNet network. The DeviceNet communications power is also supplied through this connector. The connector provided with the Controller is the FKC 2.5/5-STF-5.08 AU M (Phoenix Contact).

3-1-2 External Dimensions



3-1-3 MS and NS Indicators

The indicators show the status of the Digital Controller and the DeviceNet Network.

Indicator	Name	Color	Status	Meaning (main errors)
MS	Module status	Green		The Controller is normal.
		Red		Fatal error <ul style="list-style-type: none"> • Controller error • Watchdog timer error (DeviceNet communications)
				Non-fatal error <ul style="list-style-type: none"> • Unit error • Unit changed • Display Unit error • Non-volatile memory error
		OFF		No power is being supplied. <ul style="list-style-type: none"> • DeviceNet communications power is not being supplied. • Power is not being supplied to the Controller. • The Controller is being reset. • Waiting for initialization to start.
NS	Network status	Green		Online/communications established (normal network status)
				Online/communications not established (waiting for connection to be established with the master)
		Red		Fatal communications error (The Controller has detected an error that does not allow communications with the network.) <ul style="list-style-type: none"> • Node address duplication error • Bus OFF error detected
				Non-fatal communications error <ul style="list-style-type: none"> • Communications timeout
		OFF		Offline or power supply is OFF <ul style="list-style-type: none"> • Waiting for completion of the master's node address duplication check. • DeviceNet communications power is not being supplied.



Normal Indicator Display

The MS and NS indicators are both lit green when the status of the Controller and the Network are normal.

3-1-4 Installation

Panel Cutout Dimensions

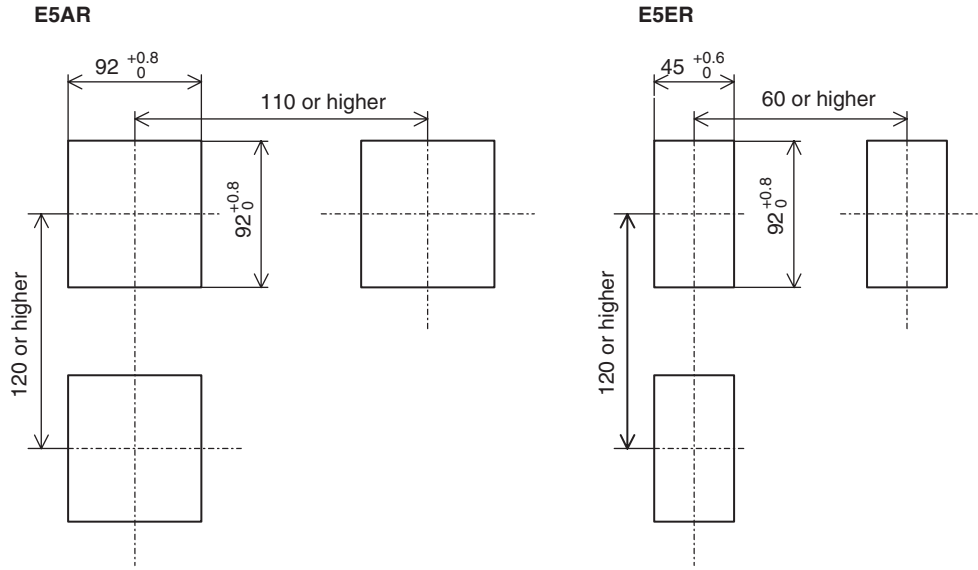

Installation Procedure

1. If the front of the Controller needs to be watertight, attach the provided watertight packing.
If the front of the Controller does not need to be watertight, the watertight packing does not need to be attached.
2. Insert the Controller into the cutout in the panel.
3. Insert the accompanying fittings into the grooves on the top and bottom of the rear case.
4. Gradually tighten the screws in the top and bottom fittings, alternating between each so that they are balanced. Tighten until the ratchet turns without engaging.

E5AR

- (1) Watertight packing (Model Y92S-P4)

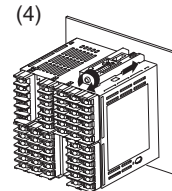
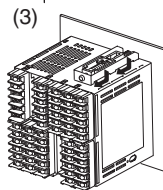
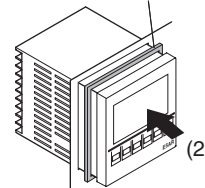

E5ER

- (1) Watertight packing (Model Y92S-P5)

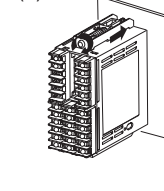
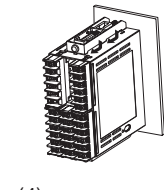
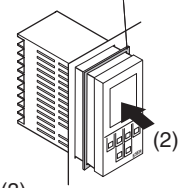

Pulling Out the Controller

Normally there is no need to pull out the Controller, however, it can be pulled out if needed for maintenance.

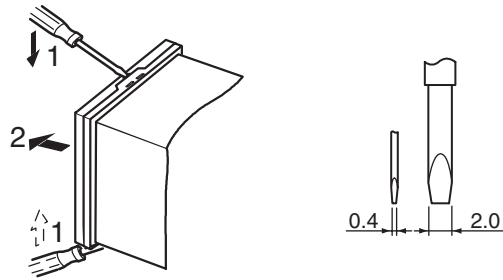

When pulling out the Controller, place a cloth over the screwdriver to prevent scratches and other damage.

Note Remove the DeviceNet connector before drawing out the Controller.

3-2 How to Use the Terminals

Verify the layout of the terminals (A on and 1 on) using the engravings on the top and sides of the case.

3-2-1 Connections

E5AR

Parts, Installation, and Wiring

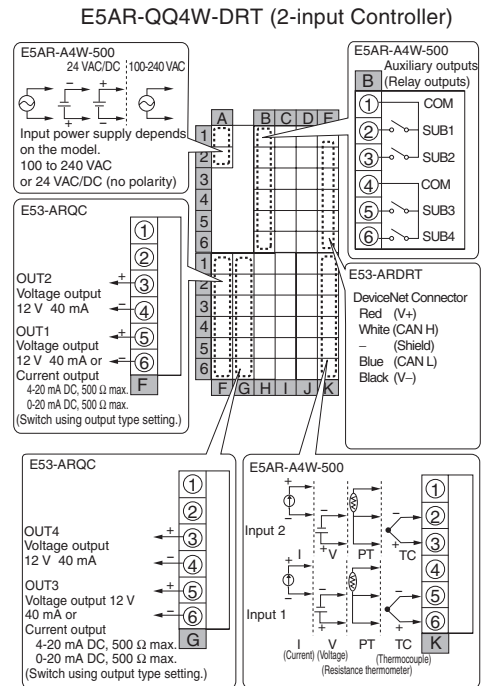
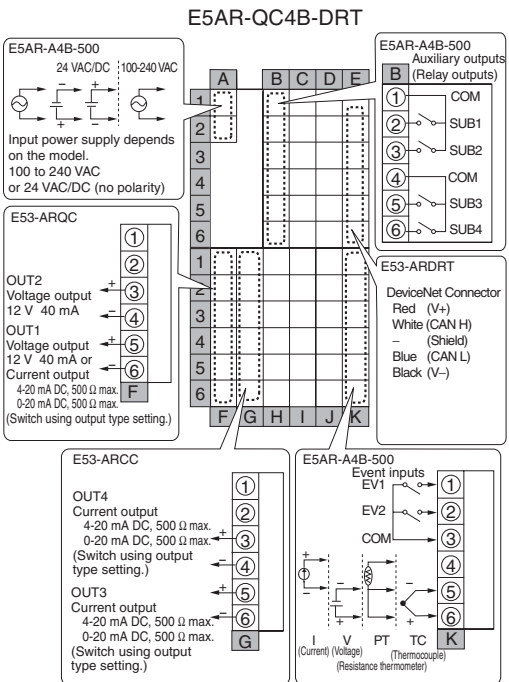
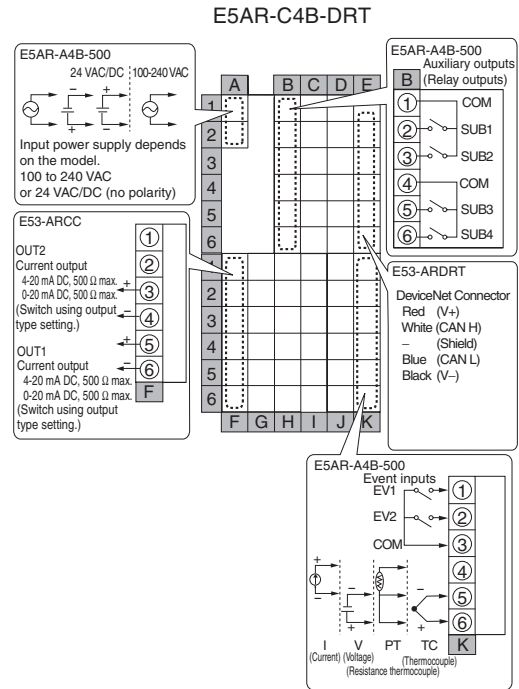
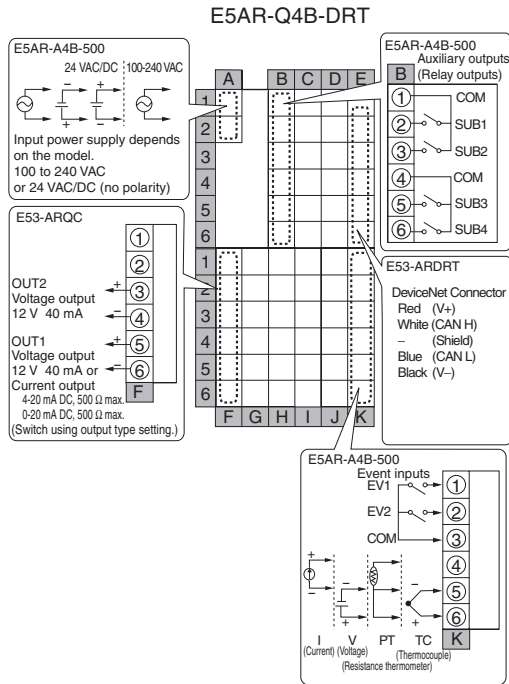

E5AR-CC4WW-DRT (4-input Controller)

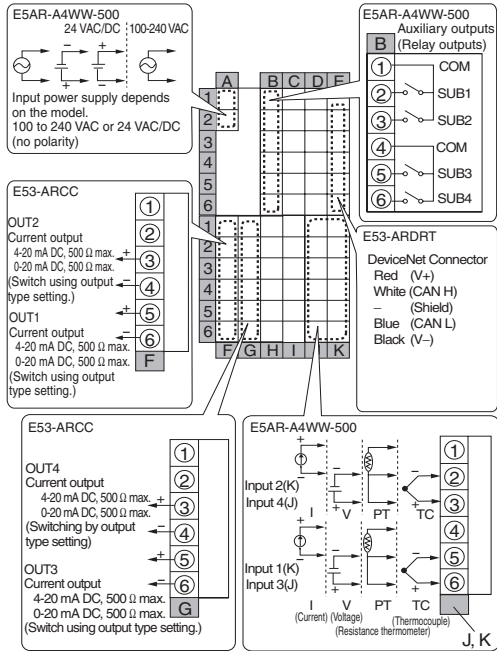

E5AR-PR4F-DRT

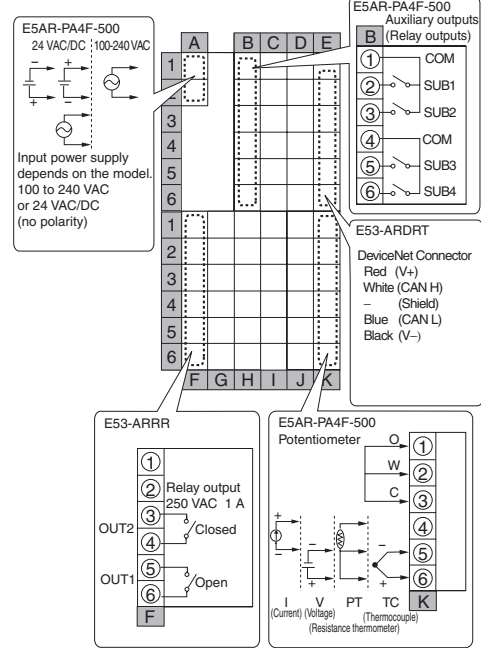

E5AR-PRQ4F-DRT

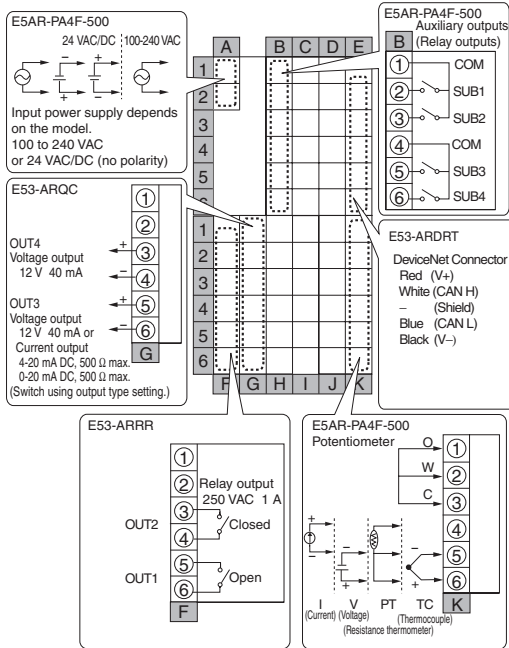

E5ER

Parts, Installation, and Wiring

E5ER-QTB-DRT

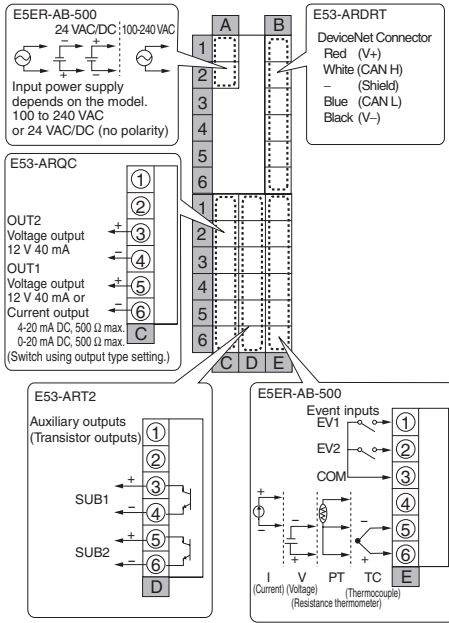

E5ER-CTB-DRT

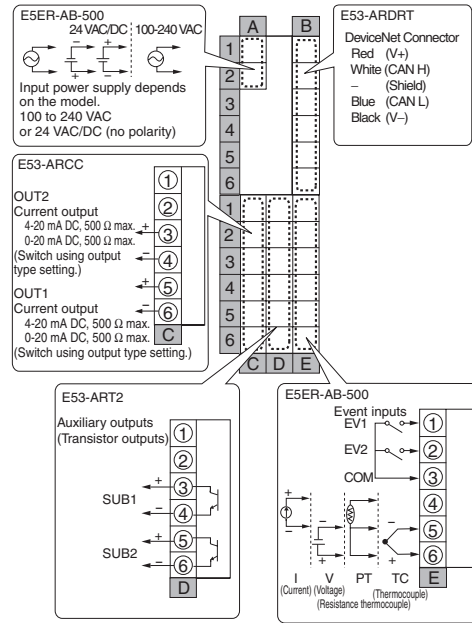

E5ER-QTW-DRT (2-input Controller)

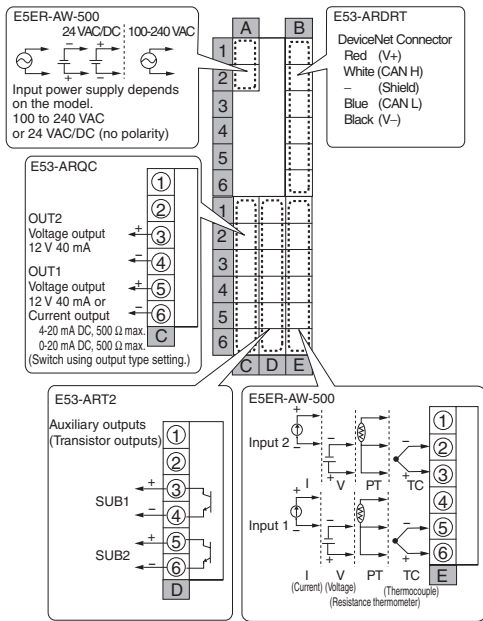

E5ER-CTW-DRT (2-input Controller)

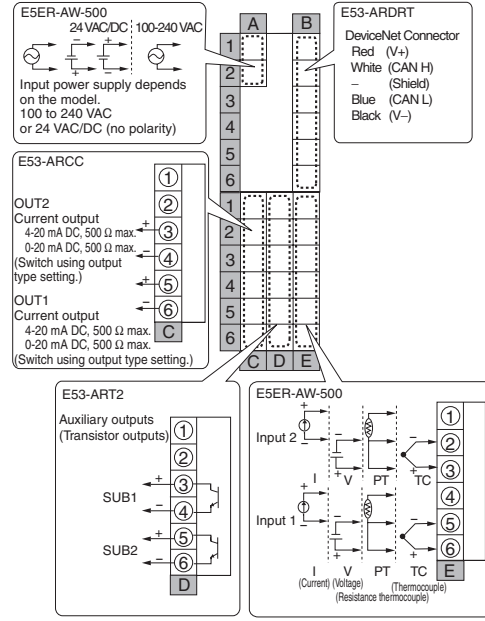

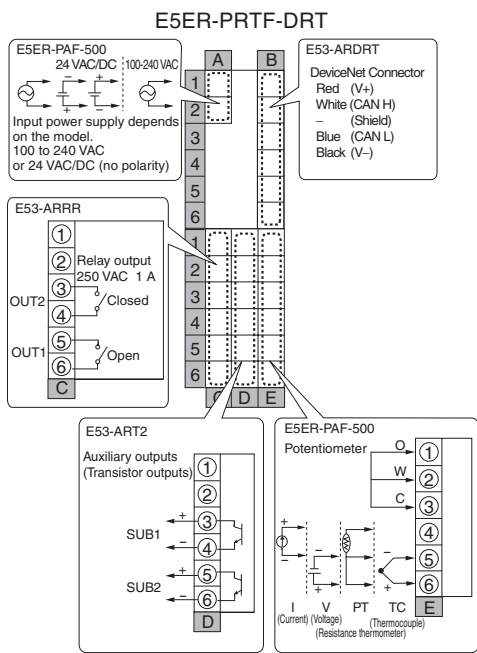

3-2-2 Precautions when Wiring

- To avoid the effects of noise, wire the signal wires and power lines separately.
- Use crimp terminals to connect to the terminals.
- Tighten screws to the following torques
Terminal block screws: 0.40 to 0.56 N·m
Connector screws: 0.25 to 0.30 N·m
- Wire the terminals so that the wires extend from the left side when viewed from the terminal block.
- The crimp terminals must be M3 and either of the following shapes.

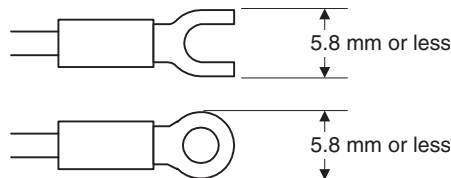

3-2-3 Wiring

Power Supply (Terminals)

The inside of the frames around terminal numbers in the wiring diagrams indicate the interior of the Controller, and the outside of the frame indicates the exterior.

- Connect terminals A1 to A2 as follows:

The input power supply depends on the model.
100 to 240 VAC, or 24 VAC/VDC (no polarity)

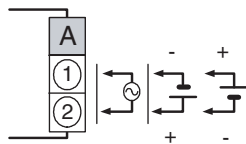

E5AR

	A	B	C	D	E	
1						1
2						2
3						3
4						4
5						5
6						6
1						1
2						2
3						3
4						4
5						5
6						6
	F	G	H	I	J	K

Input voltage	E5AR	E5ER
100 to 240 VAC 50/60Hz	22 VA	17 VA
24 VAC 50/60Hz	15 VA	11 VA
24 VDC (no polarity)	10 W	7 W

E5ER

	A	B	
1			1
2			2
3			3
4			4
5			5
6			6
1			1
2			2
3			3
4			4
5			5
6			6
	C	D	E

Inputs (Terminals)

- For Input 1 (IN1), connect terminals K4 to K6 on the E5AR, or E4 to E6 on the E5ER, as shown below according to the input type.
- For a multi-point input type, connect inputs 2 to 4 (IN2 to IN4) in the same way according to the number of input points.

E5AR

	A	B	C	D	E	
1						1
2						2
3						3
4						4
5						5
6						6
1						1
2						2
3						3
4						4
5						5
6						6
	F	G	H	I	J	K

E5AR

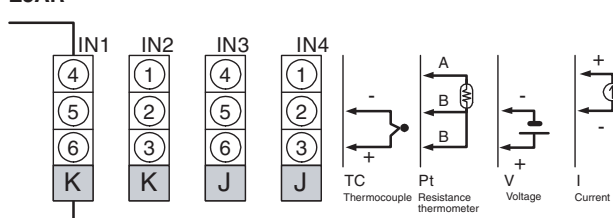

E5ER

	A	B	
1			1
2			2
3			3
4			4
5			5
6			6
1			1
2			2
3			3
4			4
5			5
6			6
	C	D	E

E5ER

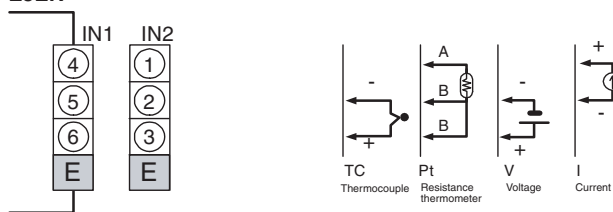

To prevent the appearance of error displays due to unused inputs, set the number of enabled channels.

Control Outputs or Transfer Outputs (Terminals)

- On the E5AR, control output 1 (OUT1) outputs to terminals F5 and F6, and control output 2 (OUT2) outputs to terminals F3 and F4.
- On the E5ER, control output 1 (OUT1) outputs to terminals C5 and C6, and control output 2 (OUT2) outputs to terminals C3 and C4.
- On a multi-point input type, output takes place from control output 3 (OUT3) and control output 4 (OUT4).

E5AR

	A		B	C	D	E	
1							1
2							2
3							3
4							4
5							5
6							6
1							1
2							2
3							3
4	OUT2	OUT4					4
5	OUT1	OUT3					5
6							6
	F	G	H	I	J	K	

E5ER

	A		B	
1				1
2				2
3				3
4				4
5				5
6				6
1				1
2				2
3				3
4	OUT2	OUT4		4
5	OUT1	OUT3		5
6				6
	C	D	E	

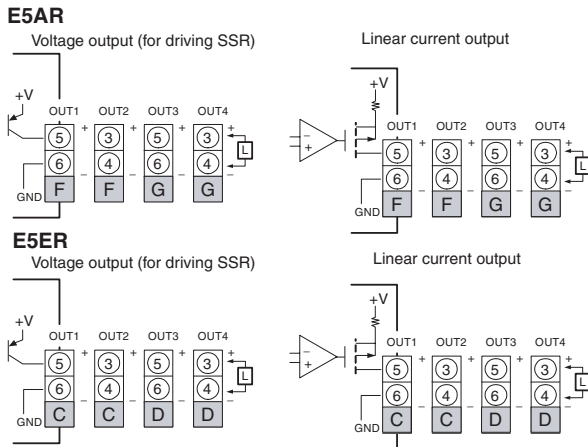

- If terminals 5 and 6 are used for voltage output (for driving SSR), approximately 2 V are output when the power is turned ON. (Load resistance: 10 kΩ or less for 10 ms)
- For linear current output, approximately 2 mA are output for 1 ms when the power is turned ON.
- Control outputs that are not used for control can be used for transfer output with the “control output/transfer output assignment” setting.
- Specifications for each output type are listed in the following table.

Output type	Specifications
Voltage output (for driving SSR)	Output voltage: 12 VDC+15%, -20% (PNP) Maximum load current: 40 mA, with short-circuit protection circuit
Linear current output	0 to 20 mA DC (resolution: approx. 54,000) 4 to 20 mA DC (resolution: approx. 43,000) Load: 500 Ω or less

- The Position-proportional Models have relay outputs (250 VAC, 1 A). Control output 1 (OUT1) is open output and control output 2 (OUT2) is closed output.

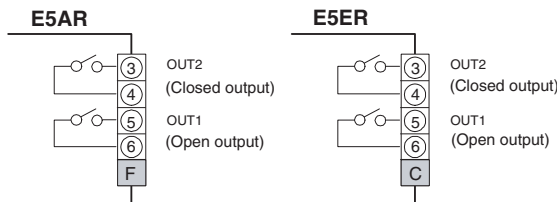

- Relay output specifications are as follows:
250 VAC, 1 A (including inrush current)

Auxiliary Outputs (Terminals)

- On the E5AR-□4□□, auxiliary outputs 1 to 4 (SUB1 to 4) output to terminals B1 to B6.
- Relay output specifications are as follows:
250 VAC 1 A

E5AR

	A	B	C	D	E	
1		COM			1	
2		SUB1			2	
3		SUB2			3	
4		COM			4	
5		SUB3			5	
6		SUB4			6	
1					1	
2					2	
3					3	
4					4	
5					5	
6					6	
	F	G	H	I	J	K

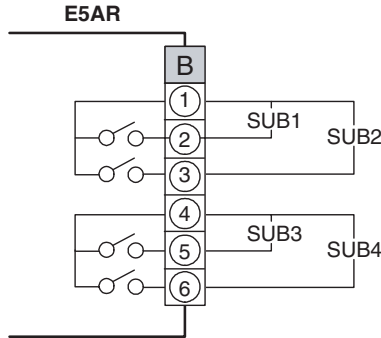

E5ER

	A	B	
1			1
2			2
3			3
4			4
5			5
6			6
1			1
2			2
3			3
4		SUB1	4
5			5
6		SUB2	6
	C	D	E

- On the E5ER-□T□□ auxiliary outputs 1 and 2 (SUB1 and 2) output to terminals D3 to D6.

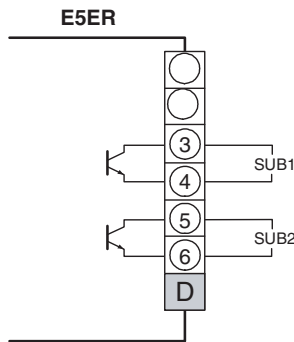

- Transistor output specifications are as follows:
Max. Load voltage: 30 VDC
Max. Load current: 50 mA
Residual voltage: 1.5 V
Leakage current: 0.4 mA

Potentiometer Inputs (Terminals)

E5AR

	A	B	C	D	E	
1						1
2						2
3						3
4						4
5						5
6						6
1					PMTR	1
2						2
3						3
4						4
5						5
6						6
	F	G	H	I	J	K

E5ER

	A	B		
1				1
2				2
3				3
4				4
5				5
6				6
1			PMTR	1
2				2
3				3
4				4
5				5
6				6
	C	D	E	

- If you want to use a Controller with position-proportional control to monitor the amount of valve opening or perform closed control, connect a potentiometer (PMTR) as shown below.

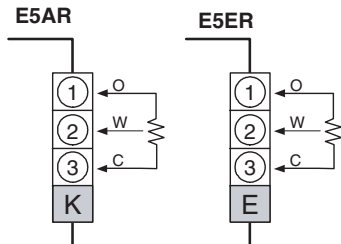

- For information on the potentiometer, see the manual for the valve you are connecting. Terminal number meanings are as follows:
O: OPEN, W: WIPE, C: CLOSE
The input range is 100 Ω to 2.5 kΩ (between C and O).

Event Inputs (Terminals)

E5AR

	A	B	C	D	E	
1						1
2						2
3						3
4						4
5						5
6						6
1					EV1	1
2					EV2	2
3					COM	3
4						4
5						5
6						6
	F	G	H	I	J	K

E5ER

	A	B		
1				1
2				2
3				3
4				4
5				5
6				6
1			EV1	1
2			EV2	2
3			COM	3
4				4
5				5
6				6
	C	D	E	

- To use the event inputs with the E5AR, connect event inputs 1 and 2 (EV1 and EV2) to terminals K1 to K3 as shown below.
- To use the event inputs with the E5ER, connect event inputs 1 and 2 (EV1 and EV2) to terminals E1 to E3 as shown below.

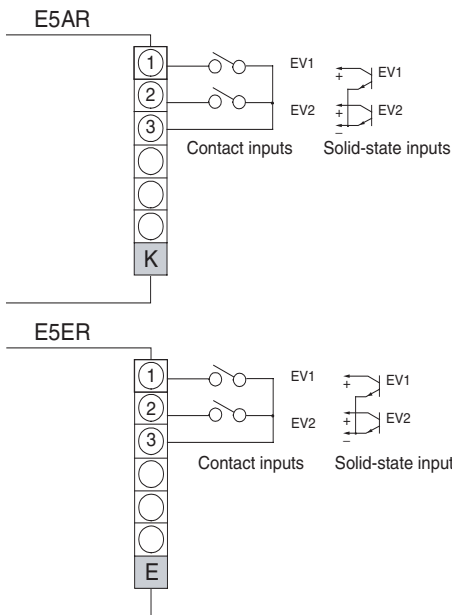

- The ratings for event inputs are given in the following table.

Contact inputs	ON: 1 KΩ max., OFF: 100 KΩ min.
Solid-state inputs	ON residual voltage: 1.5 V or less OFF leakage current: 0.1 mA or less

Circuit

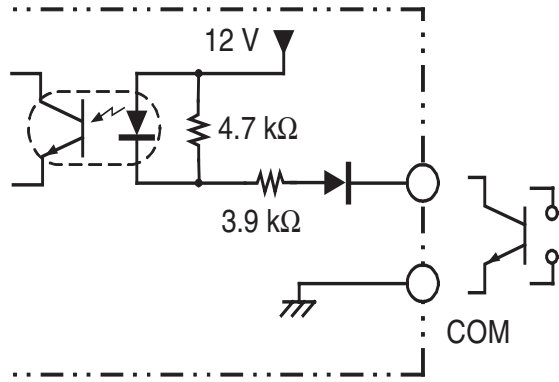

3-3 DeviceNet Communications Cables Wiring

The methods used for preparing DeviceNet communications cables to be connected for DeviceNet communications are explained here.

For details on the DeviceNet Network, such as supplying the DeviceNet communications power and grounding the DeviceNet Network, refer to the *DeviceNet Operation Manual (W267)*. The wiring methods for Thin Cable are described in this section.

3-3-1 Preparing DeviceNet Communications Cables

Use the following procedure to prepare and connect the communications cables to the connectors.

- 1,2,3...**
1. Remove approximately 30 to 80 mm of the cable covering, being careful not to damage the shield mesh underneath. Do not remove too much covering or a short circuit may result.

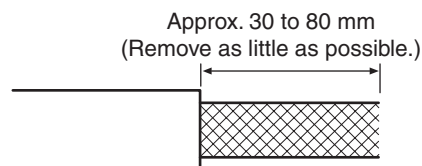

2. Carefully peel back the shield mesh to reveal the signal lines, power lines, and the shield wire. The shield wire is slightly harder to the touch than the mesh.

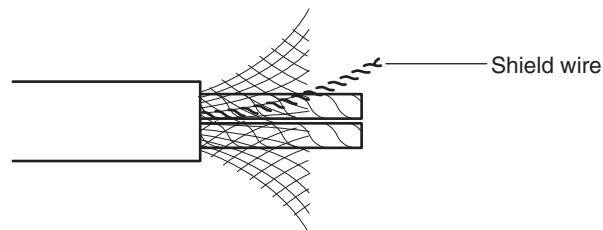

3. Remove the exposed mesh and the aluminum tape from the signal and power lines. Strip the covering from the signal and power lines to the proper length for the crimp terminals. Twist together the wires of each of the signal and power lines.

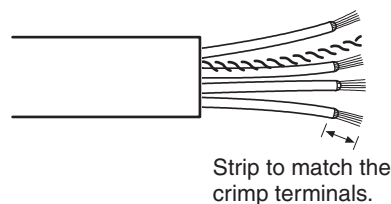

4. Attach crimp terminals to the lines and then cover any exposed areas with vinyl tape or heat-shrink tubing. Orient the connector properly, then insert each of the signal lines, power supply lines, and the shield wire into the connector holes from the top in the order red, white, shield, blue, black, as shown in the following diagram. The DeviceNet-compatible Controllers are equipped with screwless connectors, so the cables do not need to be secured with screws as with previous DeviceNet communications connectors. With the orange lever pushed down, insert each of the lines into the back of the holes. Release the orange lever and gently tug on each line to check that it is connected properly.

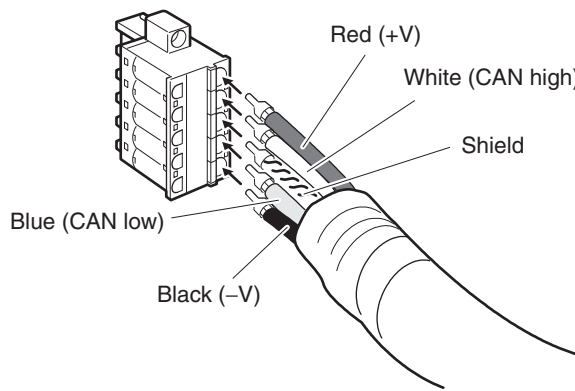

The colors correspond to the signal lines as follows:

Color	Signal
Red	Power line, positive voltage (+V)
White	Communications line, high (CAN high)
---	Shield
Blue	Communications line, low (CAN low)
Black	Communications cable, negative voltage (-V)

- We recommend the following crimp terminals (for Thin Cables)
 Power Lines: Phoenix Contact AI-series Crimp Terminals AI-0.5-6WH (product code 3200687)
 Signal Lines: Phoenix Contact AI-series Crimp Terminals AI-0.25-6BU (product code 3201291)

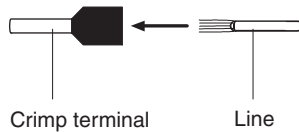

Insert the line and crimp.

The following crimp tool is also available.
 Phoenix Contact ZA3 Crimp Tool

3-3-2 Attaching the DeviceNet Communications Unit Connector

Align the DeviceNet Communications Unit connector with the cable connector, and insert the cable connector fully into the DeviceNet Communications Unit connector.

Tighten the set screws to a torque between 0.25 and 0.3 N·m to secure the connector.

E5AR

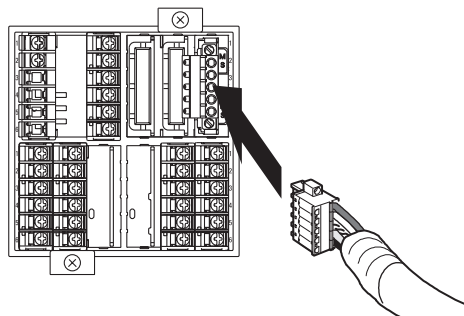

- Using the Connector Provided with the DeviceNet Communications Unit for a Multidrop Connection (Using Thin Cables)
- When using Thin Cables for a multidrop connection, two wires of the same color can be inserted into the one hole.

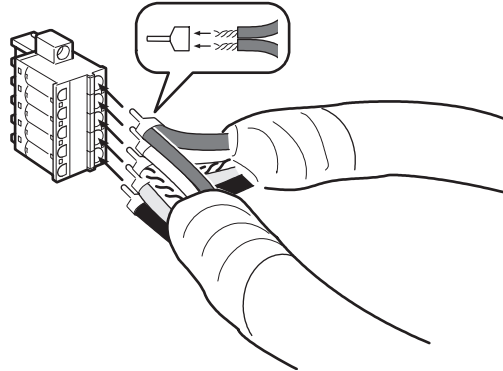

Crimp the two lines together that are to be inserted into the same hole using a special crimp terminal, as shown in the following diagram.

Crimp Terminal for Two Lines

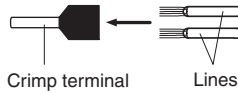

We recommend the following crimp terminals and crimp tools.

Crimp terminal	Crimp tool
Phoenix Contact	Phoenix Contact
Model: AI-TWIN2×0.5-8WH (product code 3200933)	Model: UD6 (product code 1204436)

3-3-3 Insulation Blocks

As shown in the following diagram, each function block of the E5AR/E5ER-DRT is electrically insulated.

The following are functionally insulated from each other: 1) each of the inputs, 2) event inputs, voltage outputs, and current outputs, and 3) communications.

The following are insulated from each other with basic insulation: 1) inputs, event inputs, voltage outputs, current outputs, communications, 2) relay output, and 3) transistor outputs.

If reinforced insulation is required, the input, event input, voltage output, current output, and communications terminals must be connected to devices that have no exposed chargeable parts and whose basic insulation is suitable for the applicable maximum voltage of connected parts.

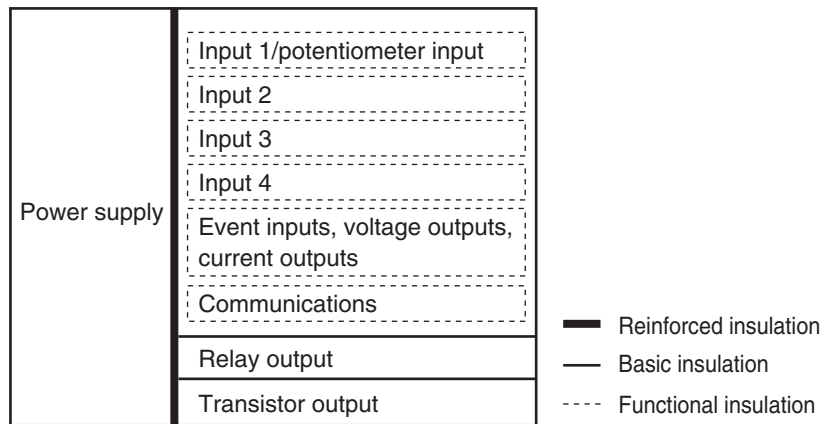

To comply with safety standards, always use an EN/IEC-compliant power supply with reinforced insulation or double insulation for the DeviceNet power supply.

Parts, Installation, and Wiring

SECTION 4

Remote I/O Communications

This section describes the input (IN) areas and output (OUT) areas that E5AR-DRT and E5ER-DRT Digital Controllers can use for remote I/O communications. The methods to allocate data for master communications are also described using sample programming.

4-1	Overview	4-2
4-2	I/O Allocation	4-2
4-2-1	Allocation Area Size	4-3
4-2-2	Allocation Parameters	4-3
4-2-3	Allocation Default Values	4-6
4-2-4	Allocation Data Size (IN Data Size and OUT Data Size)	4-7
4-2-5	Allocation Settings	4-7
4-2-6	Input Data	4-13
4-2-7	Output Data	4-13
4-2-8	Operation Commands	4-14
4-3	Ladder Programming Examples	4-15
4-3-1	RUN/STOP Sample Programming	4-15
4-3-2	Change SP Sample Programming	4-18

4-1 Overview

I/O memory in the master can be allocated to data from the E5AR/ER-DRT Digital Controller, such as data from the Digital Controller's variable area, merely by specifying what Controller data is to be transferred to where.

Data is automatically exchanged between the master and Digital Controller, allowing the Digital Controller to be controlled and monitored from the master without requiring special communications programming.

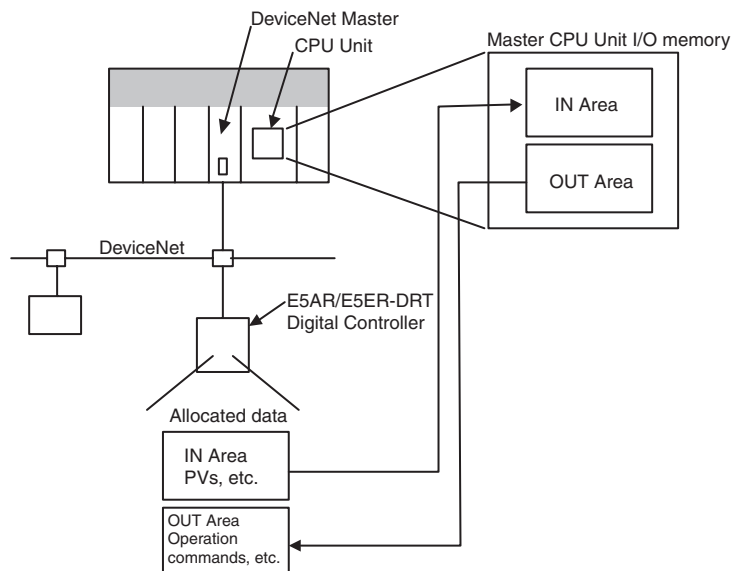

4-2 I/O Allocation

The Configurator can be used to select any data from the list of allocation parameters for the Digital Controller and then allocate the data in a user-set destination. Data is selected by specifying the allocation number assigned to the desired parameter.

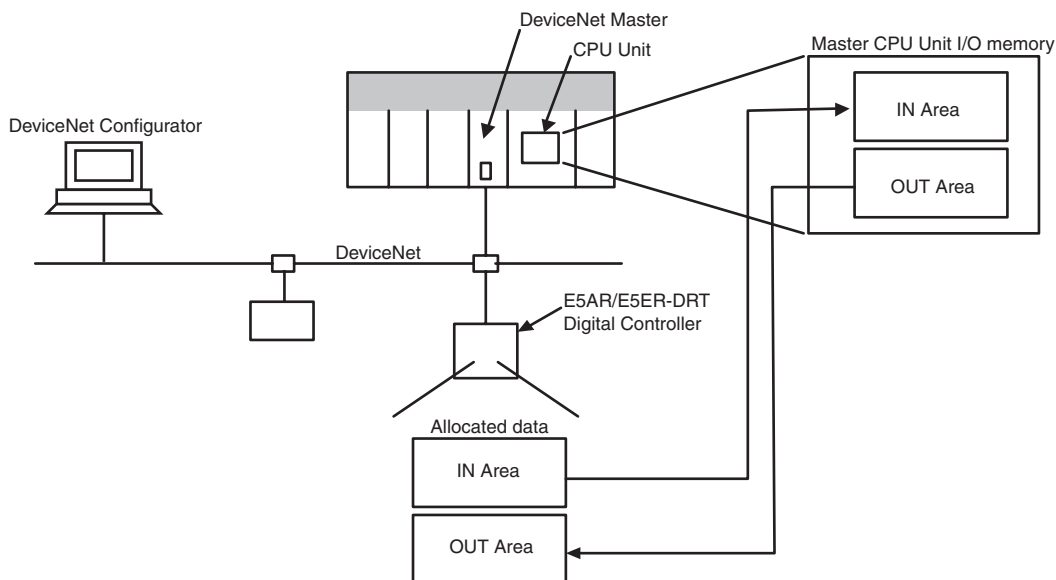

Remote I/O Communications

4-2-1 Allocation Area Size

The size of allocated data in each of the IN and OUT Areas is shown in the following table.

I/O memory	Words	Bytes	Setting	
			Allocated data size: 2 bytes	Allocated data size: 4 bytes
IN Area	0 to 100	0 to 200	100	50
OUT Area	0 to 100	0 to 200	100	50

- Note**
- (1) When the master is a CS/CJ-series DeviceNet Unit, the IN Area can be divided into two areas (IN Area 1 and IN Area 2). Any allocation data from the list of parameters can be allocated in each area.
 - (2) The actual size of the allocated area depends on the size of allocation data selected.
 - (3) The default allocation data size is two bytes.

When the allocation data size is two bytes, the monitor and setting data will be displayed in the range FFFF hex to 0000 hex. Data will be fixed at 7FFF hex or 8000 hex if the data exceeds the range that can be displayed. For example, -32769 would be displayed as 8000 hex.

The following data sizes are fixed, however.

- General status: 2 bytes (fixed)
- E5AR/ER-DRT status: 4 bytes (fixed)
- E5AR/ER-DRT Output Enable Bits and operation commands: 2 bytes (fixed)

- Note** Refer to *4-2-6 Input Data* on page 4-13 for details on General Status. Refer to *4-2-7 Output Data* on page 4-13 for details on Output Enable Bits and operation commands.

Allocation data sizes are specified for the IN Area I/O allocations and OUT Area I/O allocations. If the allocation data size is 4 bytes, up to 50 allocations can be set. Any allocations set beyond that limit will be invalid. If the total allocated area for IN Area 1 and IN Area 2 exceeds the maximum number of words (100 words), the items allocated in IN Area 2 that exceed the maximum number of words will be invalid.

4-2-2 Allocation Parameters

The parameters that can be allocated are shown below. These parameters can be broadly classified as E5AR/ER-DRT status bits/operation commands, and E5AR/ER-DRT operation data and setting data.

1. E5AR/ER-DRT Status Bits/Operation Commands

The status bits and operation commands for the E5AR/ER-DRT Digital Controller are shown in the following table.

Read	Write	Item
Yes	No	General status
No	Yes	Operation commands

- Note** (1) When items that are write-only are allocated in the IN Area, they are always set to 0.

- (2) When items that are read-only are allocated in the OUT Area, they are allocated words in memory but operate the same as if they had not been allocated.
- 2. E5AR/ER-DRT Operation Data and Setting Data
Monitor values and setting data with communications addresses that belong to the following variable types can be allocated. Duplicate settings are possible and are processed in ascending order.

Variable type	
C0	Variable type C0
C1	Variable type C1
C4	Operation monitor
C6	RUN level
C7	Adjustment level
C8	Adjustment 2 level
C9	Bank setting level
CA	PID setting level
CB	Approximation setting level

- Note** (1) If items are allocated in the read-only area of the OUT Area, words are allocated in memory but operate as if they had not been allocated.
- (2) When allocating parameters in the OUT area, do not exceed the setting ranges. If the setting ranges are exceeded when allocating parameters in the OUT area, communications errors will occur and all of the data may not be written.
- 3. Output Enable Bits
Output Enable Bits are allocated in the first word of the OUT Area. When Output Enable Bits are allocated in the IN Area, they are always set to 0 (OFF).

Note If data allocated to the IN or OUT Area is changed, use a software reset or cycle the power to enable the new settings.

Note The setting data can be written up to 100,000 times. In applications where the data allocated in the OUT area is changed frequently, change the write mode to RAM Write Mode in the Advanced Function Setting Level. Refer to the *E5AR/E5ER Digital Controller User's Manual* (Cat. No. Z182) for details on RAM Write Mode.

I/O Size Settings

When changing I/O allocations from their default settings, use the Configurator or CX-Integrator to set the I/O sizes.

Device Property Dialog Box

Use the following procedure to display the device properties.

- 1,2,3...** 1. Select the device.
- 2. Select **Properties** from the Device Menu on the Configurator or the View Menu on the CX-Integrator.
The Properties Dialog Box will be displayed.

- Click the **I/O Information** Tab.
The following I/O Information Tab Page will be displayed.

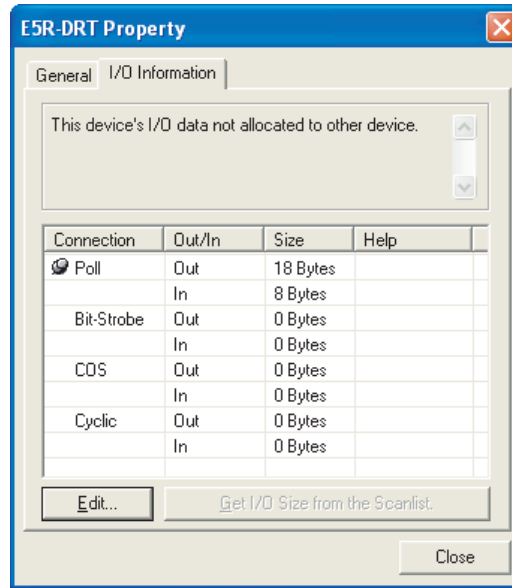

The supported I/O connection information that is defined in the EDS file will be displayed on the I/O Information Tab Page.

The icon that is shown below will appear next to the I/O connection information that is registered as the default I/O connection in the EDS file.

Connection	Out/In	Size	Help
Poll	Out	18 Bytes	
	In	8 Bytes	
Bit-Strobe	Out	0 Bytes	
	In	0 Bytes	
COS	Out	0 Bytes	
	In	0 Bytes	
Cyclic	Out	0 Bytes	
	In	0 Bytes	

Setting I/O Sizes

When changing E5AR-DRT/E5ER-DRT I/O allocations from their default settings, use the following procedure to set the above I/O sizes (i.e., I/O sizes as a slave).

- 1,2,3...** 1. Click the **Edit** Button.
The following Edit I/O Size Dialog Box will be displayed.

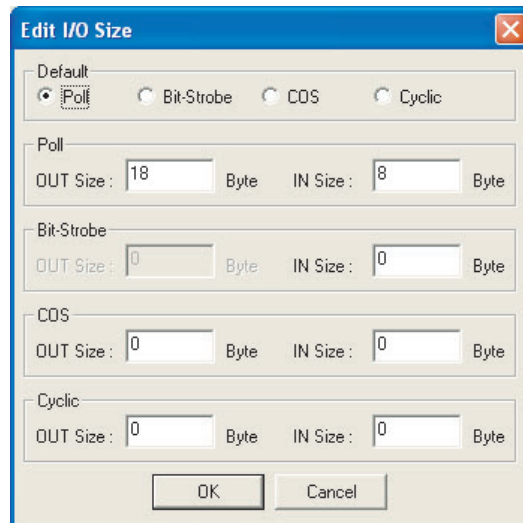

2. Select the connection type to use as the default in the Default Area. Set the sizes for all of the connection types in the Poll, Bit-Strobe, COS, and Cyclic Areas.

Getting the I/O Size Information from the Master Unit's Scan List

If an OMRON Master Unit is set to the fixed allocations or when connecting the Configurator or CX-Integrator to a network that is already running, you can get the slave I/O sizes from the scan list in the Master Unit to set the I/O sizes of the slaves. This is possible only if the master is an OMRON Master Unit. Also, the I/O sizes cannot be obtained for the slave functions of the CS1W-DRM21(-V1) and CJ1W-DRM21. Use the following procedure to get the I/O size information from the Master Unit's scan list

- 1,2,3...
1. Select the slave and then select **Properties** from the Device Menu on the Configurator or the View Menu on the CX-Integrator.
 2. Click the **I/O Information** Tab.
 3. Click the **Get I/O Size from the Scanlist** Button.

4-2-3 Allocation Default Values

The default values for I/O allocations are listed in the following table.

Area	Item	Allocation number
IN Area	PV (process value)	3
	MV (manipulated variable) monitor (heating)	13
	Status (4 bytes)	7
OUT Area	Output Enable Bits	-1
	SP (set point)	9
	Bank 0: Alarm 1 value	81
	Bank 0: Alarm 1 upper limit	82
	Bank 0: Alarm 1 lower limit	83
	Bank 0: Alarm 2 value	84
	Bank 0: Alarm 2 upper limit	85
	Bank 0: Alarm 2 lower limit	86
Operation commands	1	

Note The above monitor values and settings are all for channel 1.

4-2-4 Allocation Data Size (IN Data Size and OUT Data Size)

Setting range	Unit	Default
2byte: 2 bytes	Bytes	2 bytes
4byte: 4 bytes		

4-2-5 Allocation Settings

The I/O allocation settings are listed in the following table.

Allocated to IN Area	Allocated to OUT Area	Allocation number (2-bytes decimal)				Item	Attribute
		Channel 1	Channel 2	Channel 3	Channel 4		
No	Yes	-1	---	---	---	Output Enable Bits (Always 2 bytes)	---
Yes	Yes	0	---	---	---	Not used.	---
No	Yes	1	---	---	---	Operation command (Always 2 bytes)	---
Yes	No	2	---	---	---	General status (Always 2 bytes)	---
Yes	No	3	319	635	951	PV	ch
Yes	No	4	320	636	952	Internal SP	ch
Yes	No	5	321	637	953	Bank No. monitor	ch
Yes	No	6	322	638	954	PID set No. monitor	ch
Yes	No	7	323	639	955	Status (Always 4 bytes)	ch
Yes	Yes	8	324	640	956	Manual MV	ch
Yes	Yes	9	325	641	957	SP	ch
Yes	No	10	326	642	958	Remote SP monitor	ch
Yes	No	11	327	643	959	Set point during SP ramp	ch
Yes	No	13	329	645	961	MV monitor (heating)	ch
Yes	No	14	330	646	962	MV monitor (cooling)	ch
Yes	No	15	331	647	963	Valve opening monitor	ch
Yes	Yes	16	332	648	964	Cooling coefficient	ch
Yes	Yes	17	333	649	965	(Reserved)	ch
Yes	Yes	18	334	650	966	(Reserved)	ch
Yes	Yes	19	335	651	967	(Reserved)	ch
Yes	Yes	20	336	652	968	Dead band	ch
Yes	Yes	21	337	653	969	Manual reset value	ch
Yes	Yes	22	338	654	970	Hysteresis (heating)	ch
Yes	Yes	23	339	655	971	Hysteresis (cooling)	ch
Yes	Yes	24	340	656	972	Control period (heating)	ch
Yes	Yes	25	341	657	973	Control period (cooling)	ch
Yes	Yes	26	342	658	974	Position proportional dead band	ch
Yes	Yes	27	343	659	975	Open/close hysteresis	ch
Yes	Yes	28	344	660	976	SP ramp time unit	ch
Yes	Yes	29	345	661	977	SP ramp rise value	ch
Yes	Yes	30	346	662	978	SP ramp fall value	ch
Yes	Yes	31	347	663	979	MV at stop (Normal/heating or cooling)	ch
Yes	Yes	32	348	664	980	MV at stop (position proportional)	ch
Yes	Yes	33	349	665	981	MV at PV error (normal/heating or cooling)	ch
Yes	Yes	34	350	666	982	MV at PV error (position proportional)	ch
Yes	Yes	35	351	667	983	MV change rate limit (heating)	ch
Yes	Yes	36	352	668	984	MV change rate limit (cooling)	ch

Allocated to IN Area	Allocated to OUT Area	Allocation number (2-bytes decimal)				Item	Attribute
		Channel 1	Channel 2	Channel 3	Channel 4		
Yes	Yes	37	353	669	985	Input value 1 for input calibration	ch
Yes	Yes	38	354	670	986	Input correction 1	ch
Yes	Yes	39	355	671	987	Input value 2 for input calibration	ch
Yes	Yes	40	356	672	988	Input correction 2	ch
Yes	Yes	41	357	673	989	(Reserved)	ch
Yes	No	46	362	678	994	(Reserved)	Common
Yes	Yes	47	363	679	995	Disturbance gain	ch
Yes	Yes	48	364	680	996	Disturbance time constant	ch
Yes	Yes	49	365	681	997	Disturbance rectification constant	ch
Yes	Yes	50	366	682	998	Disturbance judgement width	ch
Yes	Yes	51	367	683	999	First order lag operation 1: Time constant	Common
Yes	Yes	52	368	684	1000	First order lag operation 2: Time constant	Common
Yes	Yes	53	369	685	1001	First order lag operation 3: Time constant	Common
Yes	Yes	54	370	686	1002	First order lag operation 4: Time constant	Common
Yes	Yes	55	371	687	1003	Move average 1: Number of measurement for moving average	Common
Yes	Yes	56	372	688	1004	Move average 2: Number of measurement for moving average	Common
Yes	Yes	57	373	689	1005	Move average 3: Number of measurement for moving average	Common
Yes	Yes	58	374	690	1006	Move average 4: Number of measurement for moving average	Common
Yes	Yes	59	375	691	1007	Extraction of square root operation 1: Low-cut point	Common
Yes	Yes	60	376	692	1008	Extraction of square root operation 2: Low-cut point	Common
Yes	Yes	61	377	693	1009	Extraction of square root operation 3: Low-cut point	Common
Yes	Yes	62	378	694	1010	Extraction of square root operation 4: Low-cut point	Common
Yes	Yes	63	379	695	1011	Analog parameter 1 (Control ratio)	Common
Yes	Yes	64	380	696	1012	(Reserved)	Common
Yes	Yes	65	381	697	1013	(Reserved)	Common
Yes	Yes	66	382	698	1014	(Reserved)	Common
Yes	Yes	67	383	699	1015	(Reserved)	Common
Yes	Yes	68	384	700	1016	(Reserved)	Common
Yes	Yes	69	385	701	1017	(Reserved)	Common
Yes	Yes	70	386	702	1018	(Reserved)	Common
Yes	Yes	71	387	703	1019	(Reserved)	Common
Yes	Yes	72	388	704	1020	(Reserved)	Common
Yes	Yes	73	389	705	1021	(Reserved)	Common
Yes	Yes	74	390	706	1022	(Reserved)	Common
Yes	Yes	75	391	707	1023	(Reserved)	Common
Yes	Yes	76	392	708	1024	(Reserved)	Common
Yes	Yes	77	393	709	1025	(Reserved)	Common
Yes	Yes	78	394	710	1026	(Reserved)	Common
Yes	Yes	79	395	711	1027	Bank 0: LSP	ch
Yes	Yes	80	396	712	1028	Bank 0: PID set No.	ch

Allocated to IN Area	Allocated to OUT Area	Allocation number (2-bytes decimal)				Item	Attribute
		Channel 1	Channel 2	Channel 3	Channel 4		
Yes	Yes	81	397	713	1029	Bank 0: Alarm 1 value	ch
Yes	Yes	82	398	714	1030	Bank 0: Alarm 1 upper limit	ch
Yes	Yes	83	399	715	1031	Bank 0: Alarm 1 lower limit	ch
Yes	Yes	84	400	716	1032	Bank 0: Alarm 2 value	ch
Yes	Yes	85	401	717	1033	Bank 0: Alarm 2 upper limit	ch
Yes	Yes	86	402	718	1034	Bank 0: Alarm 2 lower limit	ch
Yes	Yes	87	403	719	1035	Bank 0: Alarm 3 value	ch
Yes	Yes	88	404	720	1036	Bank 0: Alarm 3 upper limit	ch
Yes	Yes	89	405	721	1037	Bank 0: Alarm 3 lower limit	ch
Yes	Yes	90	406	722	1038	Bank 0: Alarm 4 value	ch
Yes	Yes	91	407	723	1039	Bank 0: Alarm 4 upper limit	ch
Yes	Yes	92	408	724	1040	Bank 0: Alarm 4 lower limit	ch
Yes	Yes	93	409	725	1041	Bank 1: LSP	ch
Yes	Yes	Same as for bank 1 for 94, 410, 726, and 1042 on.					ch
Yes	Yes	106	422	738	1054	Bank 1: Alarm 4 lower limit	ch
Yes	Yes	107	423	739	1055	Bank 2: LSP	ch
Yes	Yes	Same as for bank 1.					ch
Yes	Yes	120	436	752	1068	Bank 2: Alarm 4 lower limit	ch
Yes	Yes	121	437	753	1069	Bank 3: LSP	ch
Yes	Yes	Same as for bank 1 for 122, 438, 754, and 1070 on.					ch
Yes	Yes	134	450	766	1082	Bank 3: Alarm 4 lower limit	ch
Yes	Yes	135	451	767	1083	Bank 4: LSP	ch
Yes	Yes	Same as for bank 1 for 136, 452, 768, and 1084 on.					ch
Yes	Yes	148	464	780	1096	Bank 4: Alarm 4 lower limit	ch
Yes	Yes	149	465	781	1097	Bank 5: LSP	ch
Yes	Yes	Same as for bank 1 for 150, 466, 782, and 1098 on.					ch
Yes	Yes	162	478	794	1110	Bank 5: Alarm 4 lower limit	ch
Yes	Yes	163	479	795	1111	Bank 6: LSP	ch
Yes	Yes	Same as for bank 1 for 164, 480, 796, and 1112 on.					ch
Yes	Yes	176	492	808	1124	Bank 6: Alarm 4 lower limit	ch
Yes	Yes	177	493	809	1125	Bank 7: LSP	ch
Yes	Yes	Same as for bank 1 for 178, 493, 809, and 1126 on.					ch
Yes	Yes	190	506	822	1138	Bank 7: Alarm 4 lower limit	ch
Yes	Yes	191	507	823	1139	PID 1: Proportional band	ch
Yes	Yes	192	508	824	1140	PID 1: Integral time	ch
Yes	Yes	193	509	825	1141	PID 1: Derivative time	ch
Yes	Yes	194	510	826	1142	PID 1: Integral time (0.01 s unit)	ch
Yes	Yes	195	511	827	1143	PID 1: Derivative time (0.01 s unit)	ch
Yes	Yes	196	512	828	1144	PID 1: MV upper limit	ch
Yes	Yes	197	513	829	1145	PID 1: MV lower limit	ch
Yes	Yes	198	514	830	1146	PID 1: Automatic selection range upper limit	ch
Yes	Yes	199	515	831	1147	PID 1: Automatic selection range lower limit	ch
Yes	Yes	200	516	832	1148	PID 2: Proportional band	ch
Yes	Yes	Same as for PID 1 for 201, 517, 833, and 1149 on.					ch
Yes	Yes	208	524	840	1156	PID 2: Automatic selection range upper limit	ch
Yes	Yes	209	525	841	1157	PID 3: Proportional band	ch

Allocated to IN Area	Allocated to OUT Area	Allocation number (2-bytes decimal)				Item	Attribute
		Channel 1	Channel 2	Channel 3	Channel 4		
Yes	Yes	Same as for PID 1 for 210, 526, 842, and 1158 on.					ch
Yes	Yes	217	533	849	1165	PID 3: Automatic selection range upper limit	ch
Yes	Yes	218	534	850	1166	PID 4: Proportional band	ch
Yes	Yes	Same as for PID 1 for 219, 535, 851, and 1167 on.					ch
Yes	Yes	226	542	858	1174	PID 4: Automatic selection range upper limit	ch
Yes	Yes	227	543	859	1175	PID 5: Proportional band	ch
Yes	Yes	Same as for PID 1 for 228, 544, 860, and 1176 on.					ch
Yes	Yes	235	551	867	1183	PID 5: Automatic selection range upper limit	ch
Yes	Yes	236	552	868	1184	PID 6: Proportional band	ch
Yes	Yes	Same as for PID 1 for 237, 553, 869, and 1185 on.					ch
Yes	Yes	244	560	876	1192	PID 6: Automatic selection range upper limit	ch
Yes	Yes	245	561	877	1193	PID 7: Proportional band	ch
Yes	Yes	Same as for PID 1 for 246, 562, 878, and 1194 on.					ch
Yes	Yes	253	569	885	1201	PID 7: Automatic selection range upper limit	ch
Yes	Yes	254	570	886	1202	PID 8: Proportional band	ch
Yes	Yes	Same as for PID 1 for 255, 571, 887, and 1203 on.					ch
Yes	Yes	262	578	894	1210	PID 8: Automatic selection range upper limit	ch
Yes	Yes	263	579	895	1211	Straight-line 1 approximation: Input 1	Common
Yes	Yes	264	580	896	1212	Straight-line 1 approximation: Input 2	Common
Yes	Yes	265	581	897	1213	Straight-line 1 approximation: Output 1	Common
Yes	Yes	266	582	898	1214	Straight-line 1 approximation: Output 2	Common
Yes	Yes	267	583	899	1215	Straight-line 2 approximation: Input 1	Common
Yes	Yes	268	584	900	1216	Straight-line 2 approximation: Input 2	Common
Yes	Yes	269	585	901	1217	Straight-line 2 approximation: Output 1	Common
Yes	Yes	270	586	902	1218	Straight-line 2 approximation: Output 2	Common
Yes	Yes	271	587	903	1219	(Reserved)	Common
Yes	Yes	272	588	904	1220	(Reserved)	Common
Yes	Yes	273	589	905	1221	(Reserved)	Common
Yes	Yes	274	590	906	1222	(Reserved)	Common
Yes	Yes	275	591	907	1223	(Reserved)	Common
Yes	Yes	276	592	908	1224	(Reserved)	Common
Yes	Yes	277	593	909	1225	(Reserved)	Common
Yes	Yes	278	594	910	1226	(Reserved)	Common
Yes	Yes	279	595	911	1227	Broken-line 1 approximation: Input 1	Common
Yes	Yes	Same pattern as for straight-line 1 approximation for 280, 596, 912, and 1228 on.					Common
Yes	Yes	298	614	930	1246	Broken-line 1 approximation: Input 20	Common
Yes	Yes	299	615	931	1247	Broken line 1 approximation: Output 1	Common
Yes	Yes	Same pattern as for straight-line 1 approximation for 300, 616, 932, and 1248 on.					Common
Yes	Yes	318	634	950	1266	Broken line 1 approximation: Output 20	Common

Note Do not use allocation numbers that are reserved.

E5R Status

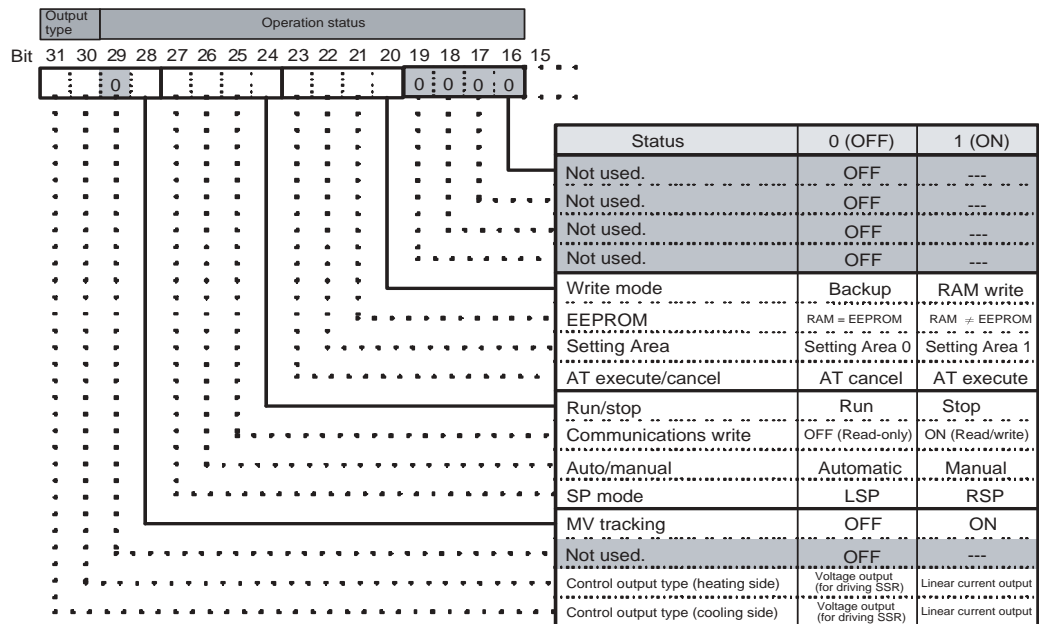
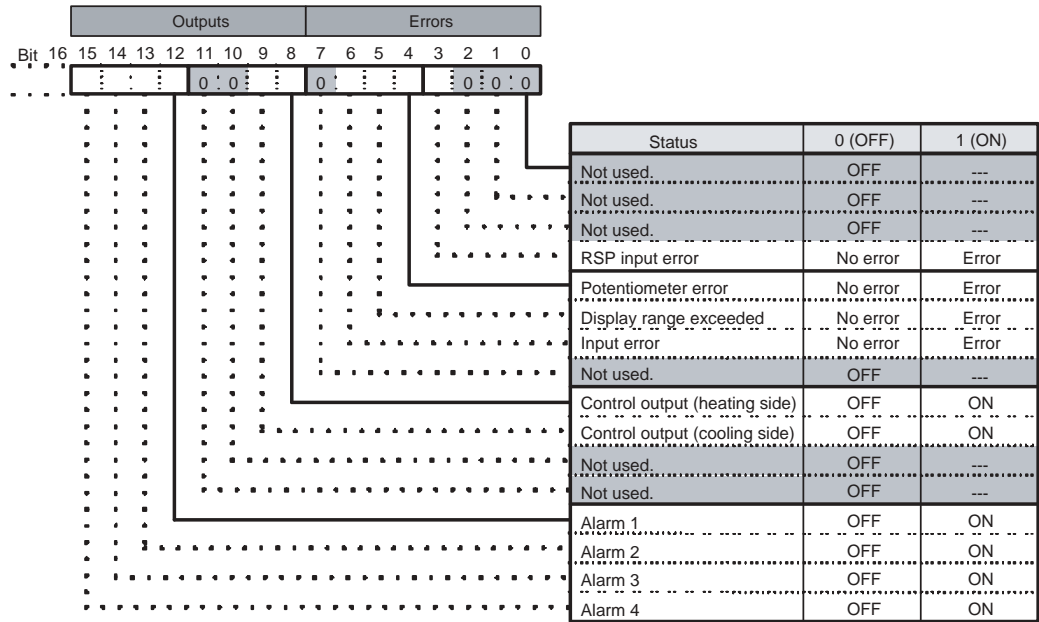

Note: The status for Setting Area 1 would be as follows when read:

- RSP input error: Clear
- Potentiometer error: Clear
- Display range exceeded: Clear
- Input error: Clear
- Control output (heating side) and control output (cooling side): Clear
- Alarm 1, alarm 2, alarm 3, and alarm 4: Clear
- AT: Clear
- Run/stop: ON (Stop)
- Auto/manual: Hold previous value
- SP mode, MV tracking: Refresh
- Control output type (heating), control output type (cooling): Refresh

- Note** (a) Position-proportional models have an open output for control output (heating side) and a closed output for control output (cooling side).
- (b) Control output (both heating and cooling sides) is always OFF for linear outputs.
- (c) Either the control output (heating) or control output (cooling) is OFF for voltage outputs (for driving SSR), depending on the control output type.

4-2-6 Input Data

The input data specific to Digital Controllers with DeviceNet communications that is not allocated in the variable area of the E5AR/ER-DRT is described here.

General Status (Setting: 2)

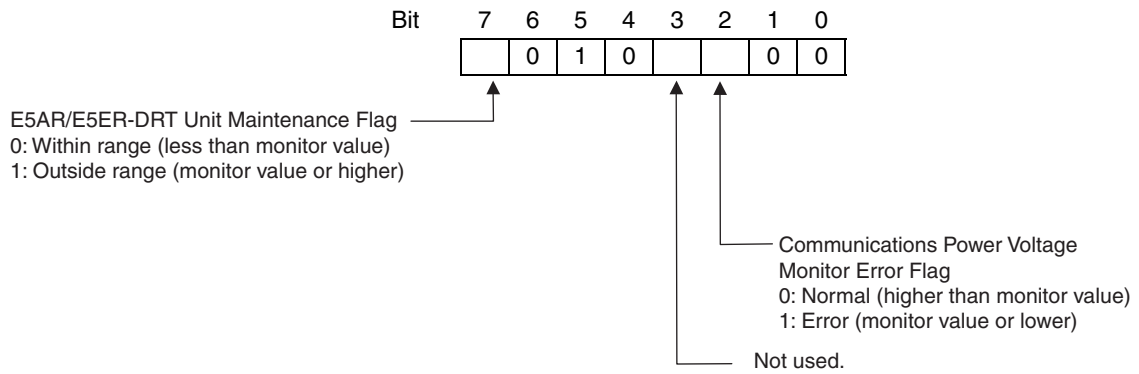

- The Communications Power Voltage Monitor Error Flag indicates the status of the power being supplied through the DeviceNet communications cable.
- The Unit Maintenance Flag is set to 1 when the total ON time or run time of the E5AR/ER-DRT Digital Controller exceeds the monitor value.

4-2-7 Output Data

Output data specific to DeviceNet that is not allocated to the E5AR/E5ER variable area is described here.

Output Enable Bits

Output Enable Bits are used when settings are written to the OUT Area, e.g., when SP are set or RUN/STOP is executed using operation commands. The area for Output Enable Bits is always allocated in the first word of the OUT Area.

When Output Enable Bits are set to 0 (OFF), the settings and bits set in the OUT Area are not transmitted and, therefore, nothing is executed. The settings can be executed by setting the Output Enable Bits to 1 (ON). Writing is not executed if the Output Enable Bits are not set to 1.

Setting Output Enable Bits prevents unintentional setting changes and enables various settings in the OUT Area to be enabled simultaneously. For example, a new value may be written to a word for which a SP has already been set. If the Output Enable Bits are set to 1 and then set to 0, no SP will be written even if one is accidentally allocated. (However, care must be taken because writing is enabled if Output Enable Bits are set to 1.)

Furthermore, if set values are written for all the channels and the Output Enable Bits are set to 1, the set values will all be enabled at once.

Note When Output Enable Bits are set to 1, data allocated to the OUT Area is written whenever it changes.

4-2-8 Operation Commands

Operation commands are used to RUN and STOP, to move to setting area 1, and other similar operations. As shown in the following table, operation commands are executed using a combination of command codes, related information, and strobes.

Operation commands cannot be executed while changing setting using key operations.

Command code	Details	Related information		Memory write area
		Upper byte	Lower byte	
00	Communications write	0 (See note 1.)	0: OFF (Read only) 1: ON (Read/write)	Non-volatile memory
01	RUN/STOP	0 to 3, F (See note 2.)	0: Run; 1: Stop	Depends on write mode.
02	Bank selection	0 to 3, F (See note 2.)	0 to 7: Bank 0 to bank 7	Depends on write mode.
03	AT execute	0 to 3, F (See note 2.)	0: Current PID set number 1 to 8: PID set number	Does not write data.
04	Write mode	0 (See note 1.)	0: Backup mode 1: RAM write mode	Non-volatile memory
05	RAM data save	0 (See note 1.)	0	Non-volatile memory
06	Software reset	0 (See note 1.)	0	Does not write data.
07	Move to Setting Area 1	0 (See note 1.)	0	Does not write data.
08	Move to protect level	0 (See note 1.)	0	Does not write data.
09	Auto/manual	0 to 3, F (See note 2.)	0: Auto mode 1: Manual mode	Depends on write mode.
0A	AT cancel	0 to 3, F (See note 2.)	0: Cancel	Does not write data.
0B	Initialize setting	0 (See note 1.)	0	Non-volatile memory
0C	Latch reset	0 to 3, F (See note 2.)	0	Does not write data.
0D	SP mode	0 to 3, F (See note 2.)	0: LSP; 1: RSP	Depends on write mode.

- Note**
- (1) Operations apply to all channels.
 - (2) The channel is specified.
0: Channel 1; 1: Channel 2; 2: Channel 3; 3: Channel 4; F: All channels
 - (3) The write mode defaults are in backup mode.

Operation commands are created as shown in the following diagram.

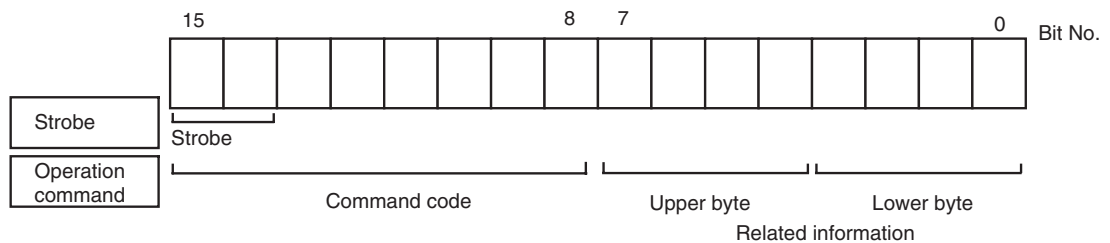

Bit 15 is strobe 2 and bit 14 is strobe 1. A logical OR is taken between the two leftmost bits of the command code and bits 15 and 14, and the result is attached as the strobe to the operation command. The command code for E5AR/ER operation commands is 0 hex, so when the logical OR is 8 hex, the strobe is ON.

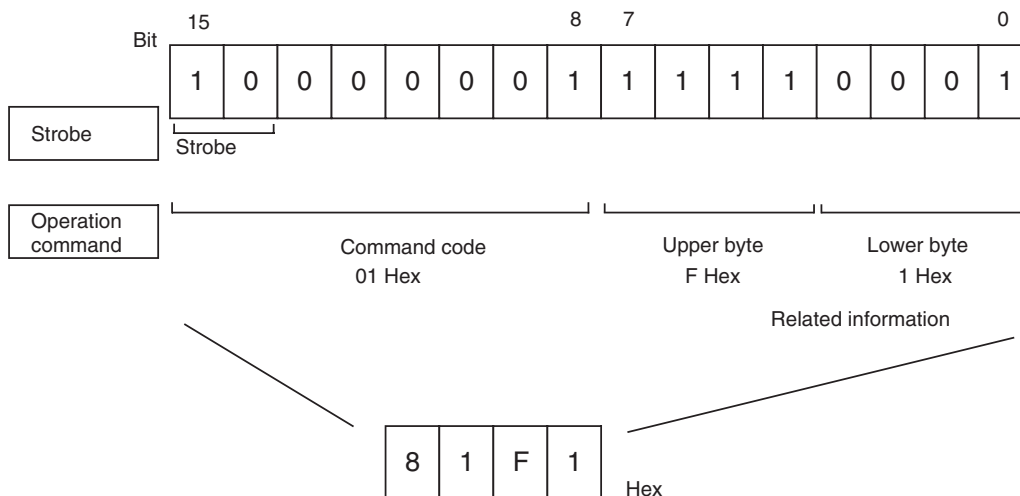

With the CS1W-DRM21 and CJ1W-DRM21 DeviceNet Units, operation commands are made ready for execution by writing to the allocated words (CIO 3209 when the default I/O allocation (fixed allocation area 1) is set.)

Operation commands are executed only when the Output Enable Bit is set to 1 (ON) and the strobe is ON. The strobe is ON when the following two conditions are met:

1. Strobe 2 = 1 and strobe 1 = 0
2. The strobe was cleared after the previous operation command was executed.

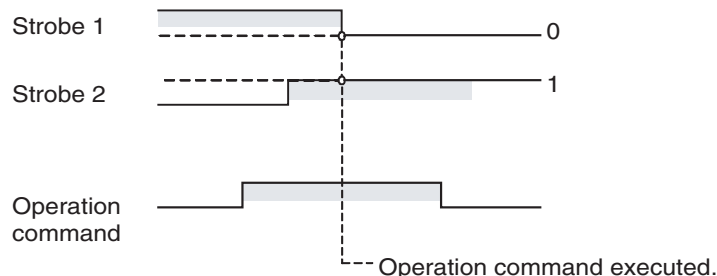

Note Software resets are executed again even if the strobe has not been cleared. Therefore the Output Enable Bit or the strobe must be cleared after the software reset command has been sent.

4-3 Ladder Programming Examples

4-3-1 RUN/STOP Sample Programming

The RUN/STOP ladder programming example here is executed under the following conditions.

- Using default I/O allocations to allocate data in fixed allocation area 1 of a CS/CJ-series DeviceNet Unit (OUT Area = CIO 3200 to CIO 3263, IN Area = CIO 3300 to CIO 3363).

Outline

This ladder programming example executes RUN and STOP for the E5AR/ER-DRT. RUN and STOP are executed using operation commands.

Output Enable Bit (CIO 320100) and strobe are used to execute the operation command.

Operation

- First, the Output Enable Bit is turned ON. The hexadecimal values are set to D1000 and D1001 at the start of the ladder program. These values prepare the channel 1 RUN operation command 0100 hex and the STOP operation command 0101 hex.
- RUN is executed for channel 1 when CIO 000000 turns ON.
- The contents of D1000 (= 0100 hex) is copied to CIO 3209, where the operation command is allocated.
- The strobe is turned ON (strobe 1 = 0 and strobe 2 = 1) and the operation command is executed. The RUN/STOP status is checked and the strobe is disabled for RUN (to prevent unintentional setting changes.)
- STOP is executed when CIO 000100 turns ON. The contents of D1000 (= 0100 hex) is copied to CIO 3209, where the operation command is allocated.

■ Programming Example

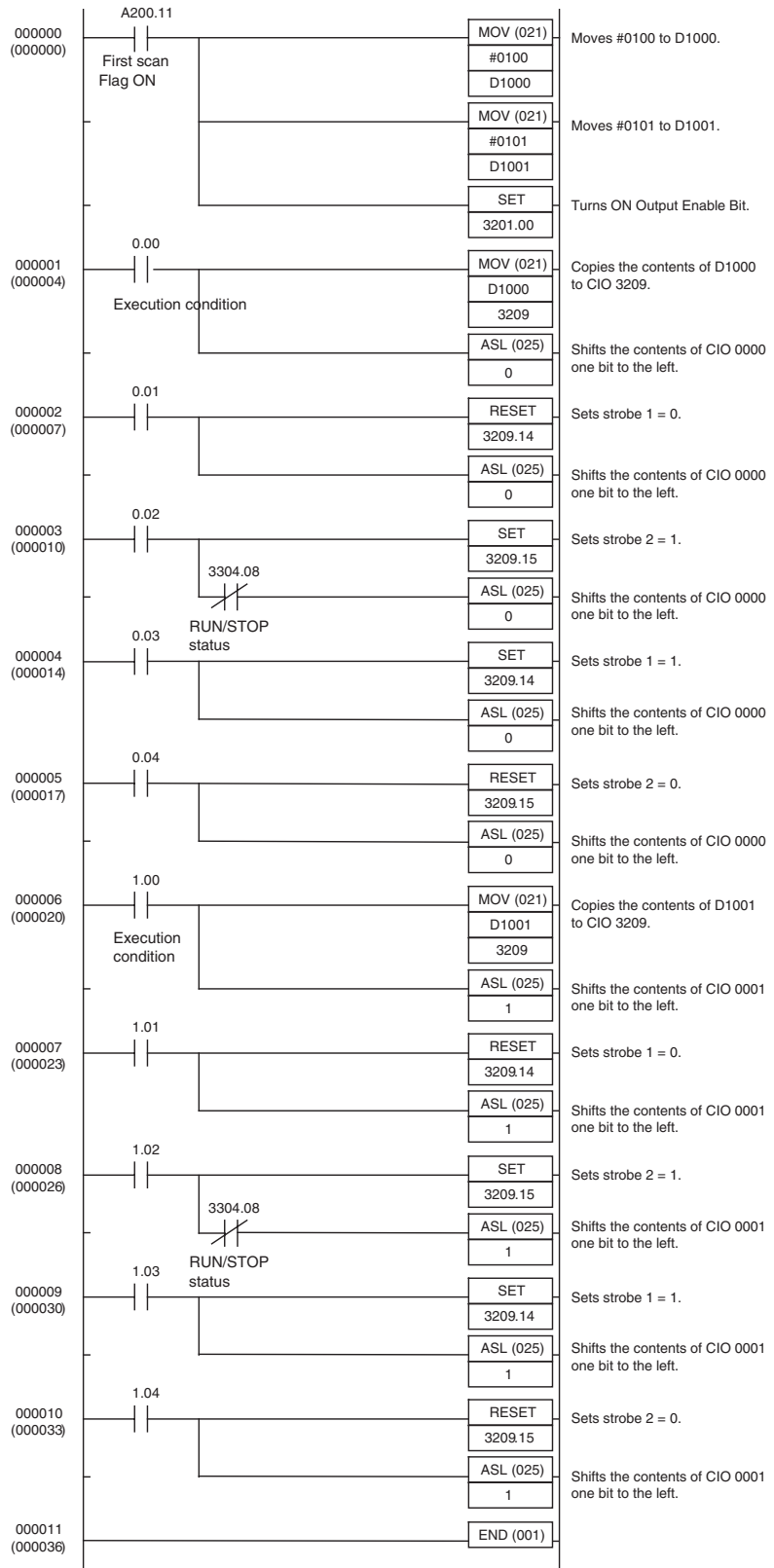

Remote I/O Communications

4-3-2 Change SP Sample Programming

The ladder programming example here is for setting and changing SP. The program is for execution under the following conditions.

- Using simple I/O allocation to allocate data in fixed allocation area 1 of a CS/CJ-series DeviceNet Unit of CS/CJ-series DeviceNet Unit (OUT Area = CIO 3200 to CIO 3263, IN Area = CIO 3300 to CIO 3363).

Outline

This ladder program example sets and changes the SP for the E5AR/ER-DRT. Output Enable Bit (CIO 320100) is used to write SP.

Operation

- The value used as SP is set in D1000 and D1001 at the start of the ladder program. In this example, the SP is set to 100.0, so the hexadecimal number 03E8 is written to D1000.
- Once the execution condition (CIO000000) turns ON, the SP is set to CIO 3202.
- The Output Enable Bit (CIO320200) is turned ON and the SP is written.
- A timer is used to turn OFF the Output Enable Bit after 0.1 s (see note).

Note: If using this kind of ladder programming, do not use the timer method shown here. Instead, allocate the SP, check that the setting has changed, and then turn OFF the Output Enable Bit using the following steps.

1. Use a Configurator or other Programming Device to allocate the SP to the IN Area.
2. Check that the SP has been written and then turn OFF the Output Enable Bit.

Programming Example

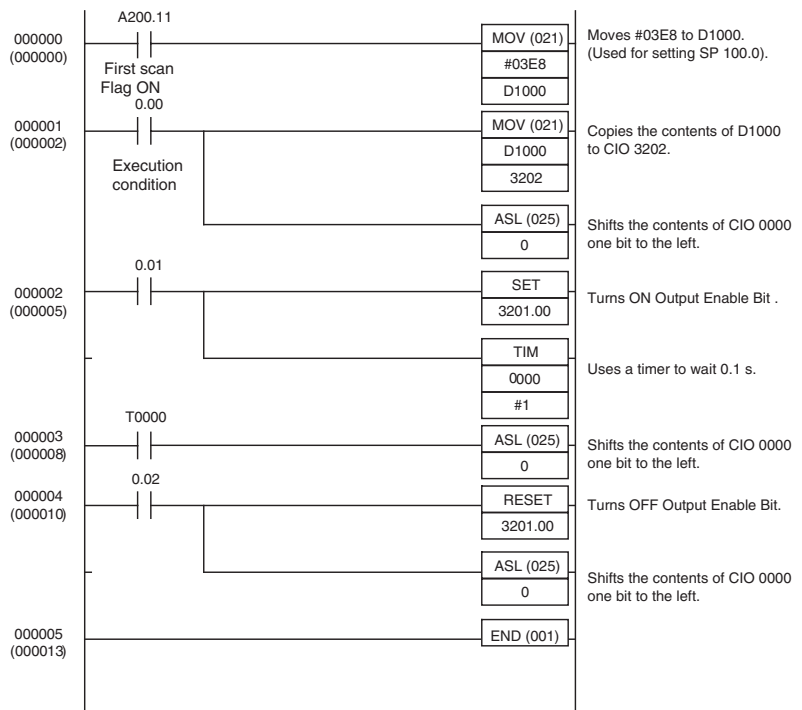

SECTION 5

Explicit Message Communications

This section describes how to send explicit messages to the E5AR/E5ER-DRT Digital Controller, including how to send CompoWay/F commands using explicit messages.

5-1	Overview of Explicit Message Communications	5-2
5-1-1	Explicit Message Communications	5-2
5-1-2	Explicit Message Types	5-2
5-1-3	Explicit Messages Basic Format.	5-3
5-2	Sending CompoWay/F Commands to the Digital Controller	5-4
5-2-1	CompoWay/F Binary Commands.	5-5
5-2-2	CompoWay/F ASCII Commands	5-5
5-3	Explicit Messages Specific to DeviceNet-compatible Digital Controllers	5-6
5-3-1	Reading General Status.	5-7
5-3-2	Writing Maintenance Mode Data	5-7
5-3-3	Setting and Monitoring the Digital Controller Channels	5-7

5-1 Overview of Explicit Message Communications

5-1-1 Explicit Message Communications

Explicit message communications is a communications protocol for sending commands from the master as explicit messages, and receiving explicit messages as responses from the nodes that receive the commands.

Explicit messages can be sent from the master to the Digital Controller to read and write the E5AR/E5ER Digital Controller variable area, send operation commands, and read and write various other DeviceNet functions supported by the Digital Controller.

Explicit message communications can be used to send and receive data that is not allocated in the IN and OUT Areas due to word size restrictions, and data that does not require the frequent refreshing used by the IN Area and OUT Area.

Use either of the following two methods depending on the application.

Reading/Writing E5AR/E5ER Variable Area Data and Sending Operation Commands

Send CompoWay/F communications commands to E5AR/E5ER Digital Controllers by embedding them in explicit messages.

Reading/Writing E5AR/E5ER-DRT Maintenance Information

Send explicit messages specific to the DeviceNet-compatible Digital Controller.

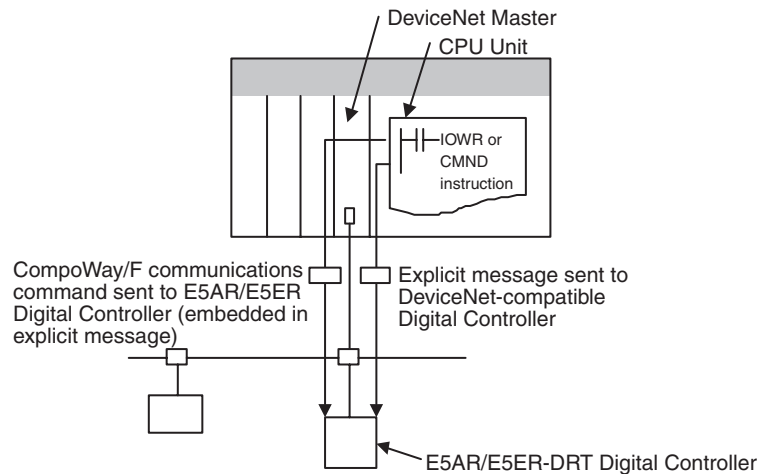

5-1-2 Explicit Message Types

The explicit messages sent to the Digital Controller can be divided into two types: messages in which CompoWay/F commands are embedded and messages specific to DeviceNet-compatible Digital Controllers.

Sending CompoWay/F Commands to the E5AR/E5ER-DRT (Embedded in Explicit Messages)

The master can send CompoWay/F communications commands to the E5AR/E5ER Digital Controller by sending them as explicit message data.

When DeviceNet-compatible Digital Controllers are used, the explicit messages are automatically converted to CompoWay/F communications commands and sent to the E5AR/E5ER-DRT Digital Controller. The responses from the Digital Controller are converted into explicit messages and returned to the master. CompoWay/F commands are used to read from and write to the E5AR/E5ER variable area and to execute operation commands.

CompoWay/F commands consist of binary commands and ASCII commands.

■ **CompoWay/F Binary Commands**

CompoWay/F binary commands are CompoWay/F communications commands expressed in hexadecimal, and are easy to execute from ladder programs. CompoWay/F communications commands that include ASCII data, however, cannot be sent or received. Therefore, Read Controller Attribute (05 03) and broadcasting (unit number = XX) cannot be used.

■ **CompoWay/F ASCII Commands**

CompoWay/F ASCII commands are CompoWay/F communications commands expressed in ASCII, so numerical values must be converted to ASCII when executing these commands from a ladder program. CompoWay/F binary commands cannot be used. Broadcasting (unit number = XX) cannot be used, but all other CompoWay/F communications commands can be sent and received, including Read Controller Attribute (05 03), which cannot be used with CompoWay/F binary commands.

Sending Explicit Messages Specific to DeviceNet-compatible Digital Controllers

The master can send explicit messages to a DeviceNet-compatible Digital Controller to control various operations supported only by DeviceNet-compatible Digital Controllers and to read DeviceNet-specific settings and status information.

These explicit messages are used to read and write maintenance information specific to DeviceNet-compatible Digital Controllers.

5-1-3 Explicit Messages Basic Format

The basic formats of explicit message commands and responses are described here.

Command Block

Destination node address	Service code	Class ID	Instance ID	Attribute ID	Data
--------------------------	--------------	----------	-------------	--------------	------

Destination Node Address

This parameter specifies the node address of the Controller to which the explicit messages (commands) will be sent in single-byte (2-digit) hexadecimal.

Service Code, Class ID, Instance ID, Attribute ID

These parameters specify the command type, processing target, and processing details.

The Attribute ID does not need to be specified for some commands.

Data

Specifies the details of the commands, set values, etc. The data section is not required for read commands.

Response Block

The following format is used when a normal response is returned for the sent explicit message.

No. of bytes received	Source node address	Service code	Data
-----------------------	---------------------	--------------	------

The following format is used when an error response is returned for the sent explicit message.

No. of bytes received 0004 hex, fixed	Source node address	Service code	Error code (2 bytes, fixed)
--	---------------------	--------------	--------------------------------

Number of Bytes Received

The number of data bytes received from the source node address is returned as a hexadecimal. When an error response is returned for the explicit message, the contents is always 0004 hex.

Source Node Address

The node address of the master that sent the explicit message is returned as a hexadecimal.

Service Code

For normal responses, the service code specified in the command turns with the most significant bit (bit 07) turned ON is returned. (For example, when the service code of the command is 0E hex, the service code of the response will be 8E hex.) When an error response is returned for the explicit message, the service code is always 94 hex.

Data

Read data is included in the response only when a read command is executed. There is no data for commands that do not read data.

Error Code

The following table shows the error codes for explicit messages.

Error code	Error name	Cause
08FF	Service not supported	The service code is incorrect.
09FF	Invalid Attribute value	The Attribute Value is not supported.
16FF	Object does not exist	The Instance ID is not supported.
15FF	Too much data	The data string is too long.
13FF	Not enough data	The data string is too short.
14FF	Attribute not supported	The Attribute ID is not supported.
0CFF	Object state conflict	The command cannot be executed.
0EFF	Attribute not settable	A write service code was sent for a read-only Attribute ID.
20**	Invalid Parameter	There is an error in the specified parameter.

5-2 Sending CompoWay/F Commands to the Digital Controller

The master can send CompoWay/F command frames to the E5AR/E5ER-DRT Digital Controller by embedding them in explicit message commands, and receive CompoWay/F response frames that are embedded in explicit messages responses.

The following services, however, cannot be used.

- Monitor value/set data composite registration read
- Monitor value/set data composite read registration (write)
- Monitor value/set data composite read registration confirmation (read)

5-2-1 CompoWay/F Binary Commands

CompoWay/F binary commands use hexadecimal values for the CompoWay/F frames, and not ASCII. Therefore, the data volume is about half of CompoWay/F ASCII commands. The following restrictions apply.

- Read Controller Attribute (05 03), which includes ASCII in the CompoWay/F frame, cannot be used.

The following command and response formats are used when executing CompoWay/F binary commands from an OMRON Master.

Command Block

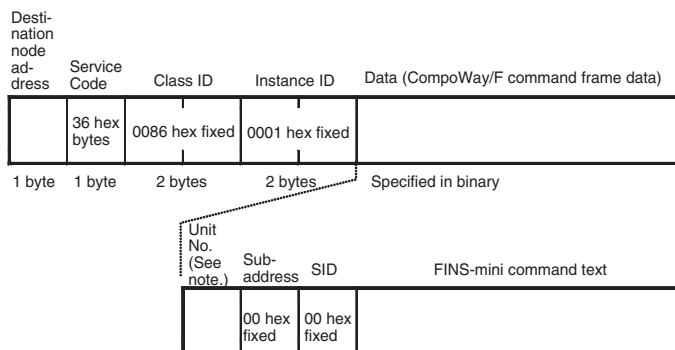

Note Specify the same value as the destination node address. Broadcasting cannot be specified.

Response Block

Normal Response

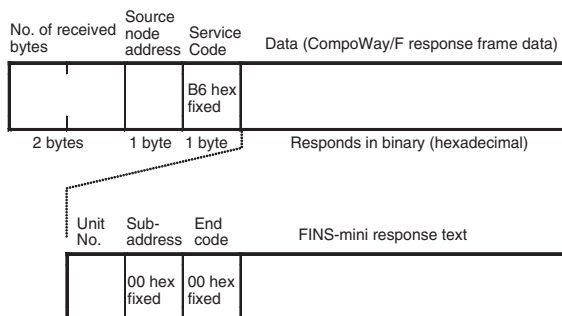

5-2-2 CompoWay/F ASCII Commands

When CompoWay/F ASCII commands are used, the CompoWay/F frames are expressed in ASCII (each digit in a specified numerical value is also converted to ASCII, so 52 is specified as ASCII 3532).

The following command and response formats are used when the commands are executed from an OMRON Master Unit.

Command Block

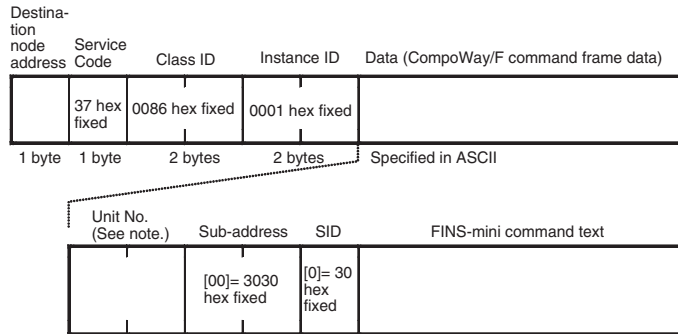

Note Specify the same value as the destination node address. Broadcasting cannot be specified.

Response Block

Normal Response

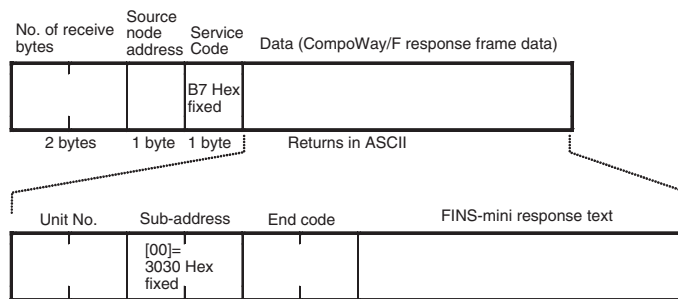

5-3 Explicit Messages Specific to DeviceNet-compatible Digital Controllers

The following list shows explicit messages that can be sent to E5AR/E5ER-DRT Digital Controllers. These messages are used to read and write maintenance information (such as Unit conduction time or total RUN time) for the DeviceNet-compatible Digital Controller.

For details on sending explicit messages from an OMRON Master PLC, refer to the DeviceNet Master Unit operation manual.

Note The number of digits used for the Class ID, Instance ID, and Attribute ID depends on the master used. When sending parameters from an OMRON Master Unit, the values are expressed as follows:

- Class ID: 4-digit (2-byte) hexadecimal
- Instance ID: 4-digit (2-byte) hexadecimal
- Attribute ID: 2-digit (1-byte) hexadecimal

5-3-1 Reading General Status

Explicit message	Read/write	Function	Command					Response
			Service code	Class ID	Instance ID	Attribute ID	Data size	
General Status Read	Read	Reads the DeviceNet-compatible Controller's general status bits (8 bits). (Refer to page 4-13).	0E hex	95 hex	01 hex	65 hex	---	1 byte

5-3-2 Writing Maintenance Mode Data

Explicit message	Read/write	Function	Command					Response
			Service code	Class ID	Instance ID	Attribute ID	Data size	
Maintenance Counter Save	Save	Records the maintenance counter (PV of total ON/RUN time for all Digital Controllers) in memory.	16 hex	95 hex	01 hex	75 hex	---	---

5-3-3 Setting and Monitoring the Digital Controller Channels

Explicit message	Read/write	Function	Command					Response
			Service code	Class ID	Instance ID	Attribute ID	Data size	
Digital Controller Channel Maintenance Information Monitor Mode	Read	Reads the monitor mode for maintenance information of the Digital Controller channel (see note 1) specified by the Instance ID (1 to 4).	0E hex	7A hex	01 to 04 hex	65 hex		1 byte 00 hex: Unit conduction time mode 01 hex: Total RUN time mode
	Write	Writes the monitor mode for maintenance information of the Digital Controller channel (see note 1) specified by the Instance ID (1 to 4).	10 hex	7A hex	01 to 04 hex	65 hex	1 byte 00 hex: Unit conduction time mode 01 hex: Total RUN time mode	
Set Value for Unit Conduction Time or Total RUN Time	Read	Reads the set value (monitor value) for the Unit conduction time or total RUN time (unit: s) of the Digital Controller channel (see note 1) specified by the Instance ID (1 to 4).	0E hex	7A hex	01 to 04 hex	68 hex		4 bytes 00000000 to FFFFFFFF hex (0 to 4294967295)
	Write	Writes the set value (monitor value) for the Unit conduction time or total RUN time (unit: s) of the Digital Controller channel (see note 1) specified by the Instance ID (1 to 4).	10 hex	7A hex	01 to 04 hex	68 hex	4 bytes 00000000 to FFFFFFFF hex (0 to 4294967295)	

Explicit message	Read/write	Function	Command					Response
			Service code	Class ID	Instance ID	Attribute ID	Data size	
Unit Conduction Time or Total RUN Time Read	Read	Reads the PV for the Unit conduction time or total RUN time (unit: s) of the Digital Controller channel (see note 1) specified by the Instance ID (1 to 4).	0E hex	7A hex	01 to 04 hex	66 hex		4 bytes 00000000 to FFFFFFFF hex (0 to 4294967295)
Monitor Status of Unit Conduction Time or Total RUN Time Read	Read	Reads the monitor status for the Unit conduction time or total RUN time (unit: s) of the Digital Controller channel (see note 1) specified by the Instance ID (1 to 4).	0E hex	7A hex	01 to 04 hex	67 hex		1 byte 00 hex: Within range 01 hex: Out of range (monitor value exceeded)

Note The following table shows the relationship between the Instance IDs (01 to 04) and the Digital Controller channels (1 to 4).

Instance ID	Channel	Instance ID	Channel
01 (01 hex)	Channel 1	02 (02 hex)	Channel 2
03 (03 hex)	Channel 3	04 (04 hex)	Channel 4

SECTION 6

Communications Performance

This section provides information on the time required for a complete communications cycle, for an output response to be made to an input, to start the system, and to send messages.

- 6-1 Remote I/O Communications Performance 6-2
 - 6-1-1 I/O Response Time 6-2
 - 6-1-2 Communications Cycle time and Refresh Processing Time. 6-3
 - 6-1-3 Networks with More Than One Master 6-4
- 6-2 Message Communications Performance. 6-6
 - 6-2-1 Message Communications Time. 6-6

6-1 Remote I/O Communications Performance

The performance of remote I/O communications between an OMRON Master Unit and OMRON Slave is described in this section. Use this information for reference with precise timing is required.

The following conditions are assumed in the calculations provided in this section.

- The Master Unit is operating with the scan list enabled.
- All required slaves are participating in communications.
- No error has occurred in the Master Unit.
- No messages are being sent on the network by Configurators or other devices from other manufacturers.

Note The calculations given in the section may not be accurate if a master from another manufacturer is used or if slaves from other manufacturers are used on the same network.

6-1-1 I/O Response Time

The I/O response time is the time required from when the master is notified of an input on an input slave until an output is made on an output slave (including ladder diagram processing in the PLC).

CS/CJ-series,
C200HX/HG/HE (-Z), and
C200HS PLCs

Minimum I/O Response Time

The minimum I/O response time occurs when the slave I/O refresh is performed immediately after the input is received by the master and the output is sent to the output slave at the beginning of the next I/O refresh.

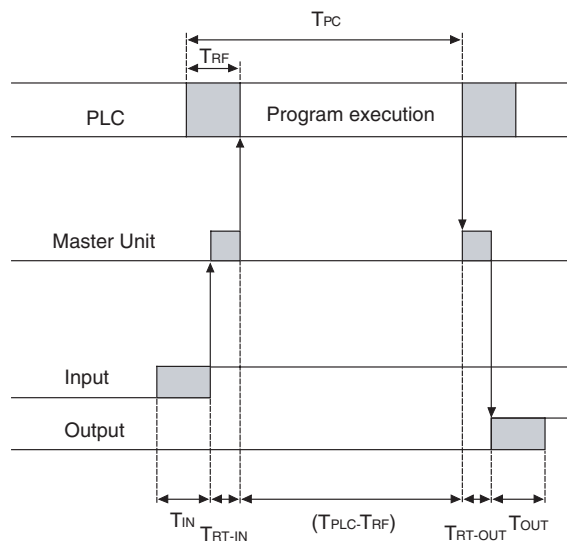

- T_{IN} : ON/OFF delay time of the input slave (0 used as minimum value)
- T_{OUT} : ON/OFF delay time of the output slave (0 used as minimum value)
- T_{RT-IN} : Communications time for one slave for input slaves
- T_{RT-OUT} : Communications time for one slave for output slaves
- T_{PLC} : Cycle time of PLC
- T_{RF} : DeviceNet Unit refresh time at PLC

Note Refer to the operation manuals for the slaves for the input slave ON/OFF delay times and the output slave ON/OFF delay times. Refer to 6-1-2 *Communications Cycle time and Refresh Processing Time* and to the operation manual for the PLC for the PLC cycle time.

The minimum I/O refresh time can be calculated as follows:

$$T_{MIN} = T_{IN} + T_{RT-IN} + (T_{PLC} - T_{RF}) + T_{RT-OUT} + T_{OUT}$$

Maximum I/O Response Time

The maximum I/O response time occurs under the conditions shown in the following diagram.

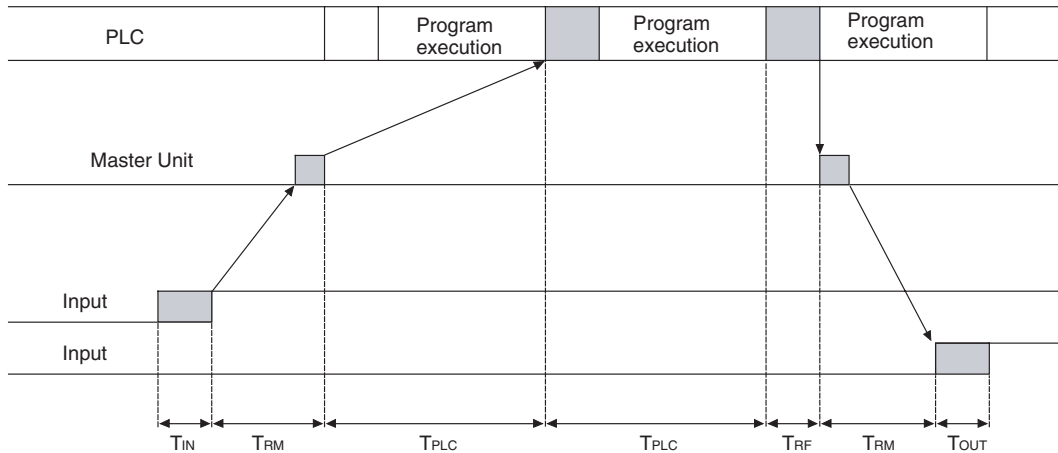

- T_{IN} : ON/OFF delay time of the input slave (0 used as minimum value)
- T_{OUT} : ON/OFF delay time of the output slave (0 used as minimum value)
- T_{RM} : Communications time for entire network
- T_{PLC} : Cycle time of PLC
- T_{RF} : DeviceNet Unit refresh time at PLC

Note Refer to the operation manuals for the slaves for the input slave ON/OFF delay times and the output slave ON/OFF delay times. Refer to 6-1-2 *Communications Cycle time and Refresh Processing Time* and to the operation manual for the PLC for the PLC cycle time.

The maximum I/O refresh time can be calculated as follows:

$$T_{MAX} = T_{IN} + 2 \times T_{RM} + 2 \times T_{PLC} + T_{RF} + T_{OUT}$$

6-1-2 Communications Cycle time and Refresh Processing Time

This section describes the communications cycle time and refresh processing time, which are required to calculate various processing times for DeviceNet.

Communications Cycle Time

The communications cycle time is the time from the completion of a slave's I/O communications processing until I/O communications with the same slave are processed again. The communications cycle time is the maximum communications cycle time $T_{IN} + T_{OUT}$.

The equations used to calculate the communications cycle time are described here.

Communications Cycle Time Equations

Total communications cycle time = IN communications cycle time + OUT communications cycle time.

■ **IN Communications Cycle Time**

IN communications cycle time = (39 ms + 8 ms x number of allocated data) + (6 ms x total allocated words in IN Areas 1 and 2)

■ **OUT Communications Cycle Time**

OUT communications cycle time = (29 ms + 27 ms x number of allocated data) + (7 ms x total allocated words in OUT Areas 1 and 2)

Refresh Processing Time

The refresh processing time is the time required for the CPU Unit of the PLC and the DeviceNet Master Unit to pass I/O information back and forth. The cycle time of the PLC is affected as described below when a DeviceNet Unit is mounted.

Note Refer to the operation manuals for the PLCs for details on the refresh processing time and the PLC's cycle time.

CS/CJ-series, C200HX/HG/HE (-Z), and C200HS PLCs

The following times for I/O refreshing are added to the cycle time of the PLC when a Master Unit is mounted.

Item	Processing time
I/O refresh	DeviceNet Unit I/O Refresh Processing
	CS/CJ-series or C200HX/HG/HE (-Z) PLCs
	1.72 + 0.022 x number of allocated words (see note) ms
	C200HS PLCs
	2.27 + 0.077 x number of allocated words (see note) ms

Note The number of allocated words is the total number of I/O area words allocated to all of the slaves. Any unused areas within the allocations must be included. For example, if only node address 1 with a 1-word input and node address 5 with a 1-word input are connected, the total number of words would be 5. When message communications are performed, the number of words required for message communications would have to be added to the above total number of words during the cycles in which message communications are processed.

6-1-3 Networks with More Than One Master

The communications cycle time, T_{RM} , when there is more than one master in the same network is described in this section. Here, a network with two masters is used as an example.

First, separate the network into two groups, slaves that perform remote I/O communications with master A and those that perform remote I/O communications with master B.

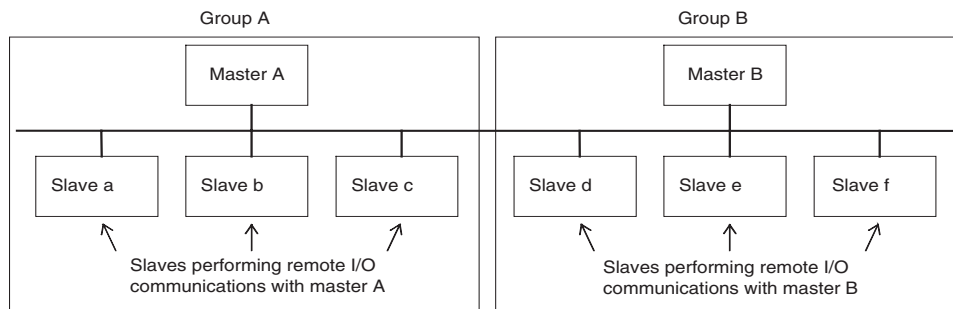

Note Although for convenience, the slave are positioned in groups with the masters, in the actual network, the physical positions of the slaves will not necessarily be related to the master with which they communicate.

Next, calculate the communications cycle time for each group referring to 6-1-2 Communications Cycle time and Refresh Processing Time.

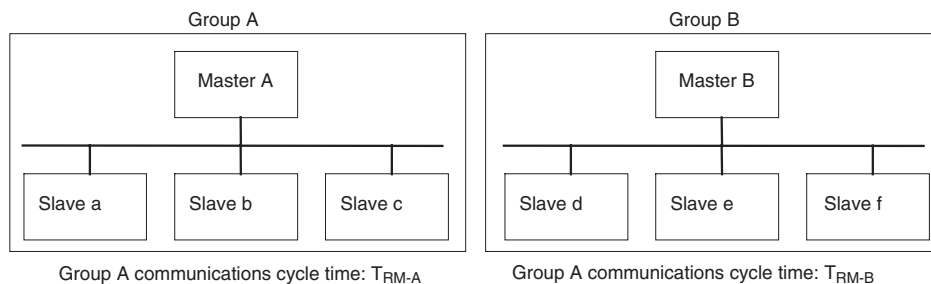

The communications cycle time for the overall network when there are two masters will be as follows:

$$T_{RM} = T_{RM-A} + T_{RM-B}$$

Although this example uses a network with only two masters, the same method can be used for any number of masters. Simply divide the network up according to remote I/O communications groups and then add all of the communications cycle times for the individual groups to calculate the communications cycle time for the overall network.

System Startup Time

This section describes the system startup time for a Network, assuming that the scan list is enabled and that remote I/O communications are set to start automatically at startup. The system startup time is the delay from the time that the Master Unit is turned ON or restarted until the time remote I/O communications begin.

The system startup time when the Master Unit is set to start up immediately after power supplies of all the slaves are turned ON is different from when the Master Unit is restarted while communications are in progress. The startup times are shown in the following table.

Condition	Slave's indicator status	System startup time
The master is started immediately after slave startup.	NS indicator is OFF or flashing green.	6 s
The master only is restarted.	NS indicator is flashing red while the master is OFF.	8 s
The slaves only are restarted.	---	10 s

Sample Program

The times described above are required for the DeviceNet system to start. The sample program in this section shows how to use the Master Slave Status to skip slave I/O processing until remote I/O communications have started.

Note Refer to the operation manual for the Master Unit for information on the Master Status Area.

The following conditions apply to this sample program.
 PLC: CS1 Series
 Master Unit's unit number: 00

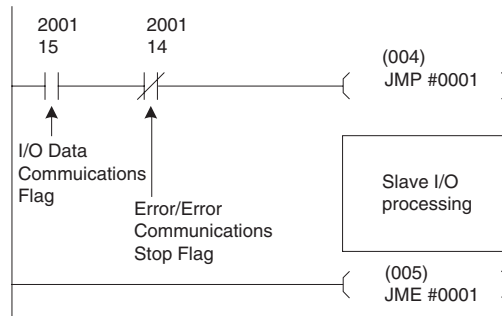

6-2 Message Communications Performance

6-2-1 Message Communications Time

The message communications time is the time required from when the Master Unit starts to send a message on the network until the entire message has been sent when a message is being sent from one node to another. The message will consist of data for a SEND or RECV instruction and a FINS command for an IOWR or CMND instruction.

Note If another message is sent before the message communications time elapses or is a message is received from another node before the message communications time elapses, the response message being sent or the message being received may be corrupted. When performing message communications it is thus necessary to allow the message communications time to elapse before performing message communications again using SEND, RECV, CMND, or IOWR instructions and to allow the message communications time to elapse between sending messages to the same node. If a send or receive message is corrupted, a record will be stored in the error log in the Master Unit. Use a FINS command to read the error record or use the Configurator to monitor the error log.

The message communications time can be estimated using the following equation:

$$\text{Message communications time} = \text{Communications cycle time} \times \{(\text{number of message bytes} + 15) \div 6 + 1\}$$

The number of message bytes in the number of bytes after the FINS command code. The communications cycle time will depend on whether remote I/O communications is being used and can be calculated as described next.

Only Message Communications (Remote I/O Communications Stopped)

$$\text{Communications cycle time} = 2 \text{ (see note)} + 0.11 \times \text{TB} + 0.6 \text{ ms}$$

TB depends on the baud range as follows:

500 KB/s: 2, 250 KB/s: 4, 125 KB/s: 8

Note The communications cycle time when remote I/O communications are stopped is 2 ms.

Message Communications and Remote I/O Communications

Communications cycle time = (communications cycle time for only remote I/O communications + 0.11 x TB + 0.6 ms

TB depends on the baud range as follows:

500 KB/s: 2, 250 KB/s: 4, 125 KB/s: 8

Note The above calculations for the message communications times are only for use as guidelines. They do not produce maximum values. The message communications time depends on the frequency of messages, the load on the remote node, the communications cycle time, etc. If network traffic is concentrated on one Master Unit, long times will be required that those produced by the above calculations. Be sure to consider this when designing the system.

SECTION 7

Troubleshooting and Maintenance

This section describes error processing, periodic maintenance operations, and troubleshooting procedures needed to keep the DeviceNet Network operating properly. Details on resetting replaced Controllers are also provided. Read through the error processing procedures in both this manual and the operation manual for the DeviceNet master being used before operation so that operating errors can be identified and corrected more quickly.

7-1	Indicators and Error Processing	7-2
7-2	Maintenance	7-3
7-2-1	Cleaning	7-3
7-2-2	Inspection	7-3
7-2-3	Replacing Controllers	7-4

7-1 Indicators and Error Processing

The following table lists the indicator status when errors occur, the probable causes and processing.

Indicator status	Probable cause	Remedy
MS: OFF NS: OFF	The power is not being supplied to the Controller.	Supply communications power from the DeviceNet connector.
	The power voltage is not within the permitted range.	Use a power supply voltage within the permitted range.
	The Controller is faulty.	Replace the Controller.
MS: Flashing red NS: No change	A checksum error has occurred in the parameters registered in EEPROM.	Repairs are required if this error persists even if the parameters are reset. Contact your nearest OMRON representative.
	A EEPROM hardware error has occurred.	
MS: ON red NS: OFF	The Digital Controller is faulty	Repairs are required. Contact your nearest OMRON representative.
MS: ON green NS: Flashing green	Waiting to connect to DeviceNet communications.	Check the following items and restart the Controller. <ul style="list-style-type: none"> • Are lengths of cables (trunk and branch lines) correct? • Are cables short-circuited, broken, or loose? • Are cables wired correctly? • Is terminating resistance connected to both ends of the trunk line only? • Is noise interference excessive? • Is the power to the master ON?
	The Digital Controller is faulty.	Repairs are required. Contact your nearest OMRON representative.
MS: ON green NS: ON red	The DeviceNet is in Bus OFF status.	Check the following items and restart the Controller. <ul style="list-style-type: none"> • Are lengths of cables (trunk and branch lines) correct? • Are cables short-circuited, broken, or loose? • Is terminating resistance connected to both ends of the trunk line only? • Is noise interference excessive?
	Node addresses duplicated.	Reset node addresses correctly.
	The Controller is faulty.	Repairs are required. Contact your nearest OMRON representative.
MS: ON green NS: Flashing red	A communications time-out has occurred.	Check the following items and restart the Controller. <ul style="list-style-type: none"> • Are lengths of cables (trunk and branch lines) correct? • Are cables short-circuited, broken, or loose? • Is terminating resistance connected to both ends of the trunk line only? • Is noise interference excessive?
	The Digital Controller is faulty.	Repairs are required. Contact your nearest OMRON representative.

7-2 Maintenance

This section describes the routine cleaning and inspection recommended as regular maintenance. Handling methods when replacing Controllers are also explained here.

7-2-1 Cleaning

Clean the Controllers regularly as described below in order to keep the Network in its optimal operating condition.

- Wipe the Controller with a dry, soft cloth for regular cleaning.
- When dust or dirt cannot be removed with a dry cloth, dampen the cloth with a neutral cleanser (2%), wring out the cloth, and wipe the Controller.
- Smudges may remain on the Controller from gum, vinyl, or tape that was left on for a long time. Remove these smudges when cleaning.

Note Never use volatile solvents, such as paint thinner or benzene, or chemical wipes to clean the Controller. These substances may damage the surface of the Controller.

7-2-2 Inspection

Inspect the system periodically to keep it in its optimal operating condition.

In general, inspect the system once every 6 to 12 months, but inspect more frequently if the system is used in high-temperature, humid, or dusty conditions.

Inspection Equipment

Prepare the following equipment before inspecting the system.

Equipment Required for Regular Inspection

A flat-blade and a Phillips screwdriver, a screwdriver for connecting communications connectors, a tester (or a digital voltmeter), industrial alcohol, and a clean cloth are required for routine inspection.

Other Equipment that May Be Required

A synchroscope, oscilloscope, thermometer, or hygrometer may be required.

Inspection Procedure

Check the items in the following table and correct any condition that is below standard by adjusting the Controller or improving the environmental conditions.

Inspection item	Details	Standard	Equipment
Environmental conditions	Are ambient and cabinet temperatures correct?	-10 to +55°C	Thermometer
	Are ambient and cabinet humidity correct?	25% to 85%	Hygrometer
	Has dust or dirt accumulated?	No dust or dirt	Visual inspection
Installation conditions	Are the connectors of the communications cables fully inserted?	No looseness	Phillips screwdriver
	Are the external wiring screws tight?	No looseness	Phillips screwdriver
	Are the connecting cables undamaged?	No external damage	Visual inspection

7-2-3 Replacing Controllers

The Network consists of the DeviceNet Master Unit and Slave Units. The entire network is affected when a Unit is faulty, so a faulty Unit must be repaired or replaced quickly. We recommend having spare Units available to restore Network operation as quickly as possible.

Precautions

Observe the following precautions when replacing a faulty Controller.

- After replacement make sure that there are no errors with the new Controller.
- When a Controller is being returned for repair, attach a sheet of paper detailing the problem and return the Controller to your OMRON dealer.
- If there is a faulty contact, try wiping the contact with a clean, lint-free cloth dampened with alcohol.

Note Before replacing a Controller, always stop Network communications and turn OFF the power to all the nodes in the Network.

Appendix A

Detailed DeviceNet Specifications

Data Size and Connection Types

If the connection type can be set when another company's configurator is being used, select a connection supported by the DeviceNet Communications Unit.

The following table shows the connection types and data sizes for OMRON DeviceNet Communications Units.

Model	Supported connections				Data size (bytes)	
	Poll	Bit strobe	Change of state (COS)	Cyclic	IN	OUT
E5AR/ER-DRT	Yes	Yes	Yes	Yes	0 to 200 (See note.)	0 to 200 (See note.)

Note The size of the IN/OUT Areas depends on the setting.

DeviceNet I/O communications support the following types of connections.

Connection type	Details	Remarks
Poll	Used to exchange data between the master and individual slaves by sending and receiving commands and responses. (Output data is allocated for commands and input data is allocated for responses).	---
Bit strobe	Used to broadcast commands from the master and receive input responses from multiple slaves.	By using one command only, the communications cycle time is short, but bit strobe connections can be used only with slaves with 8 or less input points.
Change of state (COS)	Normally, input and output data are sent by master and slaves at regular cycles, but with a COS connection, data is sent to the master or slave when the master or slave data changes.	By setting a long cycle interval, the Network will not be loaded with communications for minor data changes, thereby improving the overall efficiency of the Network.
Cyclic	Masters and slaves send output or input data at regular cycles.	

Device Profiles

The following device profiles contain more detailed DeviceNet specifications for DeviceNet communications if more information needs to be registered in the scan list.

General data	Compatible DeviceNet Specifications	Volume I - Release 2.0 Volume II - Release 2.0	
	Vendor name	OMRON Corporation	Vendor ID = 47
	Device profile name	Slaves: Generic Device	Profile number = 0
	Manufacturer catalog number	H124	
	Manufacturer revision	1.01	
Physical conformance data	Network current consumption	50 mA max.	
	Connector type	Open plug	
	Physical layer insulation	No	
	Supported indicators	Module, Network	
	MAC ID setting	Software switch	
	Default MAC ID	1	
	Baud rate setting	Automatic recognition	
Communications data	Supported baud rates	125 kbps, 250 kbps, and 500 kbps	
	Predefined Master/Slave connection set	Group 2 only server	
	Dynamic connection support (UCMM)	No	
	Explicit message fragmentation support	Yes	

Appendix B

Mounted Objects

Identity Object (0x01)

Object class	Attribute	Not supported
	Service	Not supported

Object instance	Attribute	ID	Contents	Get (read)	Set (write)	Value
		1	Vendor	Yes	No	47
2	Device type	Yes	No	0		
3	Product code	Yes	No	334		
4	Revision	Yes	No	1.1		
5	Status (bits supported)	Yes	No	Bit 00 only		
6	Serial number	Yes	No	Unique for each Unit		
7	Product name	Yes	No	E5R-DRT		
8	State	No	No			
Service	DeviceNet service			Parameter option		
	05	Reset	No			
	0E	Get_Attribute_Single	No			

Message Router Object (0x02)

Object class	Attribute	Not supported
	Service	Not supported
Object instance	Attribute	Not supported
	Service	Not supported
Vendor specification addition		None

DeviceNet Object (0x03)

Object class	Attribute	Not supported
	Service	Not supported

Object instance	Attribute	ID	Contents	Get (read)	Set (write)	Value
		1	MAC ID	No	No	
		2	Baud rate	Yes	No	
		3	BOI	Yes	No	00 (hexadecimal)
		4	Bus OFF counter	No	No	
		5	Allocation information	Yes	No	
	Service	DeviceNet service		Parameter option		
0E		Get_Attribute_Single	None			
4B		Allocate_Master/ Slave_Connection_Set	None			
4C		Release_Master/ Slave_Connection_Set	None			

Assembly Object (0x04)

Object class	Attribute	Not supported
	Service	Not supported

Object instance	Attribute	ID	Contents	Get (read)	Set (write)	Value
100: IN Area 1		1	Number of members in list	No	No	
101: IN Area 2		2	Member list	No	No	
110: OUT Area 1		3	Data	Yes	No	
	Service	DeviceNet service		Parameter option		
		0E	Get_Attribute_Single	None		

Connection Object (0x05)

Object class	Attribute	Not supported
	Service	Not supported
	Maximum number of active connections	1

Object instance 1	Section	Information		Maximum number of instances		
		Instance type	Explicit Message		1	
	Production trigger	Cyclic				
	Transport type	Server				
	Transport class	3				
	Attribute	ID	Contents	Get (read)	Set (write)	Value
		1	State	Yes	No	
		2	Instance type	Yes	No	00 (hexadecimal)
		3	Transport class trigger	Yes	No	83 (hexadecimal)
		4	Produced connection ID	Yes	No	
		5	Consumed connection ID	Yes	No	
		6	Initial comm. characteristics	Yes	No	21 (hexadecimal)
		7	Produced connection size	Yes	No	0176 (hexadecimal)
		8	Consumed connection size	Yes	No	
		9	Expected packet rate	Yes	Yes	01 (hexadecimal)
		12	Watchdog time-out action	Yes	No	01 (hexadecimal)
		13	Produced connection path length	Yes	No	00 (hexadecimal)
		14	Produced connection path	Yes	No	
		15	Consumed connection path	Yes	No	00 (hexadecimal)
	Service	DeviceNet service		Parameter option		
	05	Reset		None		
	0E	Get_Attribute_Single		None		
	10	Set_Attribute_Single		None		

Object instance 2	Section	Information		Maximum number of instances		
	Instance type	Polled I/O		1		
	Production trigger	Cyclic				
	Transport type	Server				
	Transport class	2				
	Attribute	ID	Contents	Get (read)	Set (write)	Value
		1	State	Yes	No	
		2	Instance type	Yes	No	01 (hexadecimal)
		3	Transport class trigger	Yes	No	82 (hexadecimal)
		4	Produced connection ID	Yes	No	
		5	Consumed connection ID	Yes	No	
		6	Initial comm. characteristics	Yes	No	01 (hexadecimal)
		7	Produced connection size	Yes	No	
		8	Consumed connection size	Yes	No	
		9	Expected packet rate	Yes	Yes	
		12	Watchdog time-out action	Yes	No	00 (hexadecimal)
		13	Produced connection path length	Yes	No	06 (hexadecimal)
	14	Produced connection path	Yes	No	See note 1.	
	15	Consumed connection path length	Yes	No	06 (hexadecimal)	
	16	Consumed connection path	Yes	No	See note 2.	
	17	Production inhibit time	Yes	No	0000 (hexadecimal)	
	Service	DeviceNet service		Parameter option		
	05	Reset	None			
	0E	Get_Attribute_Single	None			
	10	Set_Attribute_Single	None			

1. Produced Connection Paths
 IN Area 1: 20_04_24_64_30_03
 IN Area 2: 20_04_24_65_30_03
2. Consumed Connection Paths
 OUT Area: 20_04_24_6E_30_03

Object instance 4	Section	Information			Maximum number of instances	
	Instance type	COS Cyclic			1	
	Production trigger	Cyclic				
	Transport type	Server				
	Transport class	2				
	Attribute	ID	Contents	Get (read)	Set (write)	Value
		1	State	Yes	No	
		2	Instance type	Yes	No	01 (hexadecimal)
		3	Transport class trigger	Yes	No	12 (hexadecimal)
		4	Produced connection ID	Yes	No	
		5	Consumed connection ID	Yes	No	
		6	Initial comm. characteristics	Yes	No	01 (hexadecimal)
		7	Produced connection size	Yes	No	
		8	Consumed connection size	Yes	No	0800 (hexadecimal)
		9	Expected packet rate	Yes	Yes	
		12	Watchdog time-out action	Yes	No	00 (hexadecimal)
		13	Produced connection path length	Yes	No	06 (hexadecimal)
	14	Produced connection path	Yes	No	See note.	
	15	Consumed connection path length	Yes	No	04 (hexadecimal)	
	16	Consumed connection path	Yes	No	202B2401	
	17	Production inhibit time	Yes	Yes	0000 (hexadecimal)	
Service	DeviceNet service			Parameter option		
	05	Reset	None			
	0E	Get_Attribute_Single	None			
	10	Set_Attribute_Single	None			

Note Produced Connection Paths
 IN Area 1: 20_04_24_64_30_03
 IN Area 2: 20_04_24_65_30_03

Appendix C

DeviceNet Connection Hardware

DeviceNet Communications Cables

Model	Specifications	Manufacturer
DCA1-5C10	Thin Cable: 5 wires, 100 m	OMRON
DVN24-10G	Thin Cable: 5 wires, 10 m	Nihon Wire & Cable (See note 1.)
DVN24-30G	Thin Cable: 5 wires, 30 m	Nihon Wire & Cable (See note 1.)
DVN24-50G	Thin Cable: 5 wires, 50 m	Nihon Wire & Cable (See note 1.)
DVN24-100G	Thin Cable: 5 wires, 100 m	Nihon Wire & Cable (See note 1.)
DVN24-300G	Thin Cable: 5 wires, 300 m	Nihon Wire & Cable (See note 1.)
DVN24-500G	Thin Cable: 5 wires, 500 m	Nihon Wire & Cable (See note 1.)
1485C-P1-C150	Thin Cable: 5 wires, 150 m	Allen-Bradley (See note 2.)
DCA1-5CN□□W1	Cable with shielded micro-size (M12) connectors on both ends (female socket and male plug) Cable length: 0.5 m, 1 m, 2 m, 3 m, 5 m, and 10 m	OMRON
DCA1-5CN□□F1	Cable with shielded micro-size (M12) connector (female socket) on one end Cable length: 0.5 m, 1 m, 2 m, 3 m, 5 m, and 10 m	OMRON
DCA1-5CN□□H1	Cable with shielded micro-size (M12) connector (male plug) on one end Cable length: 0.5 m, 1 m, 2 m, 3 m, 5 m, and 10 m	OMRON
DCA1-5CN□□W5	Cable with shielded connector on both ends (male plug on mini-size end, female socket on micro-size end) Cable length: 1 m, 2 m, 5 m, and 10 m	OMRON

- Note**
1. The product specifications for these cables are identical to the OMRON cable specifications.
 2. The cables made by Allen-Bradley are stiffer than the cables made by OMRON and Nihon Wire & Cable Company Ltd., so do not bend the Allen-Bradley cables as much as the others.

Other DeviceNet communications cables are available from the following manufacturers. For details, refer to the product catalogs on the ODVA web site (<http://www.odva.astem.or.jp/>) or contact the manufacturer directly.

DeviceNet Connector

Model	Specifications	Manufacturer
FCK2.5/5-STF-5.08AU	For node connection Screwless type, includes connector set screws	PHOENIX CONTACT

Crimp Terminals for DeviceNet Communications Cables

Model	Crimper	Remarks	Manufacturer
AI series: AI-0.5-6WH for Thin Cable (product code: 3200687)	ZA3	For single-wire insertion	PHOENIX CONTACT
AI series: AI-0.25-6BU for Thin Cable (product code: 3201291)	UD6 (product code: 1204436)	For two-wire insertion (multi-drop wiring)	

Terminating Resistors for DeviceNet Network

Model	Specifications	Manufacturer
DRS1-T	Terminal-block Terminating Resistor, 121 Ω \pm 1% 1/4 W	OMRON
DRS2-1	Shielded Terminating Resistor (male plug), micro-size (M12)	
DRS2-2	Shielded Terminating Resistor (female socket), micro-size (M12)	
DRS3-1	Shielded Terminating Resistor (male plug), mini-size	

A Terminating Resistor can also be connected to a T-branch Tap or a one-branch Power Supply Tap.

T-branch Taps

One-branch Taps

Model	Specifications	Manufacturer
DCN1-1C	Includes three XW4B-05C1-H1-D parallel connectors with screws (When used on a trunk line, one branch line can be connected.) Connector insertion direction: Horizontal A Terminating Resistor (included as standard) can be connected.	OMRON
DCN1-2C	Includes three XW4B-05C1-H1-D parallel connectors with screws (When used on a trunk line, one branch line can be connected.) Connector insertion direction: Vertical A Terminating Resistor (included as standard) can be connected.	OMRON
DCN1-2R	Includes three XW4B-05C1-VIR-D orthogonal connectors with screws (When used on a trunk line, one branch line can be connected.) Connector insertion direction: Vertical A Terminating Resistor (included as standard) can be connected.	OMRON

Three-branch Taps

Model	Specifications	Manufacturer
DCN1-3C	Includes five XW4B-05C1-H1-D parallel connectors with screws (When used on a trunk line, three branch lines can be connected.) Connector insertion direction: Horizontal A Terminating Resistor (included as standard) can be connected.	OMRON
DCN1-4C	Includes five XW4B-05C1-H1-D parallel connectors with screws (When used on a trunk line, three branch lines can be connected.) Connector insertion direction: Vertical A Terminating Resistor (included as standard) can be connected.	OMRON
DCN1-4R	Includes five XW4B-05C1-VIR-D orthogonal connectors with screws (When used on a trunk line, three branch lines can be connected.) Connector insertion direction: Vertical A Terminating Resistor (included as standard) can be connected.	OMRON

Shielded T-branch Connectors

Model	Specifications	Manufacturer
DCN2-1	One-branch shielded T-branch connectors, three micro-size (M12) connectors	OMRON
DCN3-11	One-branch shielded T-branch connectors, three mini-size connectors	
DCN3-12	One-branch shielded T-branch connectors, two mini-size connectors and one micro-size (M12) connector	

One-branch Power Supply Tap

Model	Specifications	Manufacturer
DCN-1P	One-branch tap for power supply. Use this tap when connecting a communications power supply. Includes two XW4B-05C1-H1-D parallel connectors with screws and two fuses as standard. A Terminating Resistor (included as standard) can be connected.	OMRON

Glossary

The following table provides a list of commonly used DeviceNet terms.

Term	Explanation
Bus OFF	Indicates that the error rate in the network is extremely high. Errors are detected when a fixed threshold is exceeded by the internal error counter. (the internal error counter is cleared when the Master Unit is started or restarted.)
CAN	CAN is short for Controller Area Network. It is a communications protocol developed as a LAN for use in automobiles. DeviceNet employs CAN technology.
Configurator	A device for setting the system settings. The Configurator can read ID information, read and write parameters, and display the network configuration. OMRON's DeviceNet Configurator is designed for use with an OMRON Master Unit.
Consumed Connection Size	Indicates the data size (byte length) received via the connection.
ODVA	ODVA is short for Open DeviceNet Vendor Association, Inc. It is a non-profit organization formed by machine vendors with the aim to administer and popularize the DeviceNet specification.
Produced Connection Size	Indicates the data size (byte length) sent via the connection.
Connection	This is a logical communication channel for facilitating communications between nodes. Communications are maintained and managed between the master and slaves.
Device Profile	Standardizes the configuration and behavior (the smallest data configuration and operation that must be supported by the device) of devices of the same type (equipment, etc.). Provides mutual exchangeability between devices of the same type. Also known as a device model. Devices for which device profiles are currently being investigated include sensors, valves, display units, and encoders.
Master/Slave	A node can be either a master, which collects and distributes data, or a slave, which outputs and inputs data according to the instructions received from the master. OMRON's DeviceNet products are already provided with either master or slave functions in a pre-defined master/slave connection set.

Glossary

Index

A

accumulated ON (RUN) time monitor, 2-5
AT cancel, 4-14
AT execute, 4-14
auto mode, 4-14
auto/manual, 4-14
auxiliary outputs (terminals), 3-12

B

bank selection, 4-14
bit strobe, A-1

C

cables
 communications cables
 models, C-1
change of state (COS), A-1
cleaning, 7-3
command block, 5-3, 5-5, 5-6
communications
 cables, C-1
 connection example, 1-2
 cycle time, 6-3
 distance, 1-5
 error operation, 2-5
 performance, 1-xvii, 6-1
 specifications, 1-5
Communications Power Voltage Monitor Error Flag, 4-13
CompoWay/F ASCII commands, 5-3, 5-5
CompoWay/F binary commands, 5-3, 5-5
CompoWay/F commands, 5-4
Configurator
 operations, 2-3
connections, 2-2
 hardware, C-1
connectors
 attaching, 3-16
 models, C-1
control outputs (terminals), 3-11
crimp terminals, 3-16, C-2
 models, C-2
current consumption, 1-5
cyclic, A-1

D

device profiles, A-2
DeviceNet communications cables, C-1
 preparing, 3-15
 wiring, 3-15
DeviceNet communications connector, 2-2
DeviceNet Communications Unit connector, 3-16
DeviceNet Connector, C-1

E

EC Directives, 1-xiii
 conformance, 1-xiii
EMC Directives, 1-xiii
error codes, 5-4
event inputs (terminals), 3-13
explicit messages, 1-3, 5-2
 basic message format, 5-3
 error codes, 5-4
 General Status Read, 5-7
 Maintenance Counter Save, 5-7
 sending, 5-6
 Set Value for Unit Conduction Time or Total RUN Time, 5-7
 specific to DeviceNet, 5-6
 types, 5-2
 Unit Conduction Time or Total RUN Time Read, 5-8
external dimensions, 3-2

G

general status, 4-3, 4-13

I

I/O allocations, 4-2
 area size, 4-3
 data size, 4-3, 4-7
 default values, 4-6
 parameters, 4-3
 settings, 4-7
I/O response time, 6-2
I/O size settings, 4-4
IN Area, 4-3
indicators, 3-3, 7-2
 troubleshooting, 7-2
initialize setting, 4-14

inputs (terminals), 3-10
inspection, 7-3
installation, 3-4
instance ID, 5-8
insulation blocks, 3-18

L

latch reset, 4-14

M

maintenance, 1-xvii, 7-1, 7-3
 replacing Units, 7-4
manual mode, 4-14
message communications time, 6-6
module status (MS indicator), 3-3

N

network power monitor, 2-4
network status (NS indicator), 3-3
networks with multiple masters, 6-4

O

One-branch Power Supply Taps, C-3
One-branch Taps, C-2
operation commands, 4-14
OUT Area, 4-3
Output Enable Bits, 4-4, 4-13

P

panel cutout dimensions, 3-4
part names, 3-2
poll, A-1
potentiometer inputs (terminals), 3-13
power supply (terminals), 3-10
precautions
 wiring, 3-9
programming
 samples, 4-15, 4-18
protect level
 move to, 4-14
pulling out the Controller, 3-5

R

refresh processing time, 6-3, 6-4
remote I/O communications, 1-2, 1-3, 4-1
 performance, 6-2
removing Controllers, 3-5
replacing Controllers, 7-4
replacing Units, 7-4
response block, 5-3, 5-5, 5-6
RUN/STOP, 4-14

S

Setting Area 1
 move to, 4-14
setup procedure, 2-2
Shielded T-branch Connectors, C-3
slaves
 maximum number, 1-5
software reset, 4-14
SP mode, 4-14
specifications
 communications, 1-5
 DeviceNet, A-1
 general, 1-5
startup time, 6-5
status, 4-3, 4-11
strobe, 4-14, 4-16
supply voltage, 1-5
system startup time, 6-5

T

T-branch Taps, C-2
terminal arrangement, 3-6
Terminating Resistors, C-2
Three-branch Taps, C-2
transfer outputs (terminals), 3-11
troubleshooting, 1-xvii, 7-1

U

Unit Maintenance Flag, 4-13

W

- wiring, 3-10
 - precautions, 3-9
- write mode, 4-14

Revision History

A manual revision code appears as a suffix to the catalog number on the front cover of the manual.

Cat. No. H124-E1-02



Revision code

The following table outlines the changes made to the manual during each revision. Page numbers refer to the previous version.

Revision code	Date	Revised content
1	February 2004	Original production
02	November 2010	<p>page xviii: Completely revised tables for related manuals.</p> <p>page 2-2: Added a note at the bottom of the page.</p> <p>page 3-3: Corrected dimensions for E5ER.</p> <p>page 3-9: Added a description on wiring under 3-2-2.</p> <p>pages 3-11, 4-9, and 4-10: Changed “pulse voltage output” to “voltage output (for driving SSR)”.</p> <p>page 4-3: Updated reference pages in the middle of the page.</p> <p>page 4-4: Added a note under the variable type table.</p> <p>page 4-4: Added information on I/O size settings</p> <p>page 4-12: Added a sentence to the first paragraph.</p> <p>page I-2: Added an index item for I/O size settings.</p>

Revision History

OMRON Corporation Industrial Automation Company
Tokyo, JAPAN

Contact: www.ia.omron.com

Regional Headquarters

OMRON EUROPE B.V.

Wegalaan 67-69-2132 JD Hoofddorp
The Netherlands
Tel: (31)2356-81-300/Fax: (31)2356-81-388

OMRON ELECTRONICS LLC

One Commerce Drive Schaumburg,
IL 60173-5302 U.S.A.
Tel: (1) 847-843-7900/Fax: (1) 847-843-7787

OMRON ASIA PACIFIC PTE. LTD.

No. 438A Alexandra Road # 05-05/08 (Lobby 2),
Alexandra Technopark,
Singapore 119967
Tel: (65) 6835-3011/Fax: (65) 6835-2711

OMRON (CHINA) CO., LTD.

Room 2211, Bank of China Tower,
200 Yin Cheng Zhong Road,
PuDong New Area, Shanghai, 200120, China
Tel: (86) 21-5037-2222/Fax: (86) 21-5037-2200

Authorized Distributor:

© OMRON Corporation 2004 All Rights Reserved.
In the interest of product improvement,
specifications are subject to change without notice.

Cat. No. H124-E1-02

Printed in Japan
1110