

OMRON

E5GN

Temperature Controller

User's Manual

Cat. No. H101-E1-03A

Preface

The E5GN compact temperature controller features the following:

- The E5GN can be mounted on compact panels
- The user can select from thermocouple, platinum resistance thermometer, non-contact temperature sensor and analog voltage inputs.
- The user can select AT (auto-tuning) and ST (self-tuning) as tuning functions.
- The user can use the communications function (when the communications function is supported).
- The user can calibrate sensor input.
- The E5GN features a watertight construction (NEMA4X: equivalent to IP66).
- The E5GN conforms to UL/CSA/IEC safety standards and EMC standards.

This User's Manual describes how to use the E5GN.

Before using your E5GN, thoroughly read and understand this manual in order to ensure correct use.

Also, store this manual in a safe place so that it can be retrieved whenever necessary.

* For an additional description of the communications function, also refer to the E5AN/EN/CN/GN Temperature Controller, Communications Function User's Manuals (Cat. No. H102)

© OMRON, 1998

All rights reserved. No part of this publication may be reproduced, stored in a retrieval system or transmitted, in any form, or by any means, mechanical, electronic, photocopying, recording, or otherwise, without the prior written permission of OMRON.

No patent liability is assumed with respect to the use of the information contained herein. Moreover, because OMRON is constantly striving to improve its high-quality products, the information contained in this manual is subject to change without notice. Every precaution has been taken in the preparation of this manual. Nevertheless, OMRON assumes no responsibility for errors or omissions. Neither is any liability assumed for damages resulting from the use of the information contained in this publication.

© OMRON, 1998

All rights reserved. No part of this publication may be reproduced, stored in a retrieval system or transmitted, in any form, or by any means, mechanical, electronic, photocopying, recording, or otherwise, without the prior written permission of OMRON.

No patent liability is assumed with respect to the use of the information contained herein. Moreover, because OMRON is constantly striving to improve its high-quality products, the information contained in this manual is subject to change without notice. Every precaution has been taken in the preparation of this manual. Nevertheless, OMRON assumes no responsibility for errors or omissions. Neither is any liability assumed for damages resulting from the use of the information contained in this publication.

PRECAUTIONS

When the product is used under the circumstances or environment described in this manual always adhere to the limitations of the rating and functions. Also, for safety, take countermeasures such as fitting fail safe installations.

DO NOT USE :

- In circumstances or environments that have not been described below in this manual.
- For control in nuclear power, railway, aircraft, vehicle, incinerator, medical, entertainment, or safety applications.
- Where death or serious property damage may occur, or where extensive safety precautions are required.

SAFETY PRECAUTIONS

■ Safety Signal Words

This manual uses the following signal words to mark safety precautions for the E5GN. These precautions provide important information for the safe application of the product. You must be sure to follow the instructions provided in all safety precautions.

 WARNING	Indicates information that, if not heeded, could possibly result in loss of life or serious injury.
--	---

 CAUTION	Indicates information that, if not heeded, could result in relatively serious or minor injury, damage to the product, or faulty operation.
--	--

■ Safety Precautions

 CAUTION
<p>● Electric Shock Warning</p> <p>Do not touch the terminals while the power is ON. Doing so may cause an electric shock.</p>
<p>Do not allow metal fragments or lead wire scraps to fall inside this product. These may cause electric shock, fire or malfunction.</p>
<p>Never disassemble, repair or modify the product. Doing so may cause electric shock, fire or malfunction.</p>
<p>Do not use the product in flammable and explosive gas atmospheres.</p>
<p>The life expectancy of the output relays varies greatly with the switching capacity and other switching conditions. Always use the output relays within their rated load and electrical life expectancy. If an output relay is used beyond its life expectancy, its contacts may become fused or burned.</p>
<p>Use the product within the rated load. Not doing so may cause damage or burning.</p>
<p>Use this product within the rated supply voltage. Not doing so may cause damage or burning.</p>
<p>Tighten the terminal screws properly. Tighten them to a torque of 0.24 N·m (2.5kgf·cm) max on terminals 1 to 6. Tighten them to a torque of 0.13 N·m (1.4kgf·cm) max on terminals 7 to 9. Loose screws may cause malfunction.</p>
<p>Set all settings according to the control target of the product. If the settings are not appropriate for the control target, the product may operate in an unexpected manner, resulting in damage to the product or resulting in accidents.</p>
<p>To maintain safety in the event of a product malfunction, always take appropriate safety measures, such as installing an alarm on a separate line to prevent excessive temperature rise. If a malfunction prevents proper control, a major accident may result.</p>

NOTICE

Be sure to observe these precautions to ensure safe use.

- (1) Do not wire unused terminals.
- (2) Be sure to wire properly with correct polarity of terminals.
- (3) To reduce induction noise, separate the high-voltage or large-current power lines from other lines, and avoid parallel or common wiring with the power lines when you are wiring to the terminals. We recommend using separating pipes, ducts, or shielded lines.
- (4) Do not use this product in the following places:
 - Places subject to dust or corrosive gases (in particular, sulfide gas and ammonia gas)
 - Places subject to high humidity, condensation or freezing
 - Places subject to direct sunlight
 - Places subject to vibration and large shocks
 - Places subject to splashing liquid or oily atmosphere
 - Places directly subject to heat radiated from heating equipment
 - Places subject to intense temperature changes
- (5) To allow heat to escape, do not block the area around the product. (Ensure that enough space is left for the heat to escape.) Do not block the ventilation holes on the casing.
- (6) When you have removed the terminal plate, never touch electric components inside or subject the internal mechanism to shock.
- (7) Cleaning: Do not use paint thinner or the equivalent. Use standard grade alcohol to clean the product.
- (8) Use AWG24 to AWG14 leads for terminal Nos.1 to 6 and AWG28 to AWG22 leads for terminal Nos.7 to 9 (with lead cover peel back allowance of 5 or 6 mm).
- (9) Allow as much space as possible between the E5GN and devices that generate powerful high-frequency noise (e.g. high-frequency welders, high-frequency sewing machines) or surges.
- (10) When executing self-tuning, turn the load (e.g. heater) ON simultaneously or before you turn the E5GN ON. If you turn the E5GN ON before turning the load ON, correct self-tuning results and optimum control may no longer be obtained.
- (11) Use a 100 to 240 VAC (50/60 Hz), 24 VAC (50/60 Hz) or 24 VDC power supply matched to the power specifications of the E5GN. Also, make sure that the rated voltage is attained within two seconds of turning the power ON.
- (12) Attach a surge suppressor or noise filter to peripheral devices that generate noise (in particular, motors, transformers, solenoids, magnetic coils or other equipment that have an inductance component).
- (13) When mounting a noise filter on the power supply, be sure to first check the filter's voltage and current capacity, and then mount the filter as close as possible to the E5GN.
- (14) Use within the following temperature and humidity ranges:
 - Temperature: -10 to 55°C, Humidity: 25 to 85% (with no icing or condensation)If the E5GN is installed inside a control board, the ambient temperature must be kept to under 55°C, including the temperature around the E5GN.
If the E5GN is subjected to heat radiation, use a fan to cool the surface of the E5GN to under 55°C.
- (15) Store within the following temperature and humidity ranges:
 - Temperature: -25 to 65°C, Humidity: 25 to 85% (with no icing or condensation)
- (16) Never place heavy objects on, or apply pressure to the E5GN as it may cause it to deform and deteriorate during use or storage.
- (17) Avoid using the E5GN in places near a radio, television set, or wireless installation. These devices can cause radio disturbances which adversely affect the performance of the E5GN.

Conventions Used in This Manual

■ Meanings of Abbreviations

The following abbreviations are used in parameter names, figures and in text explanations. These abbreviations mean the following:

Symbol	Term
PV	Process value
SP	Set point
SV	Set value
AT	Auto-tuning
ST	Self-tuning
EU	Engineering unit *1

*1 “EU” stands for Engineering Unit. EU is used as the minimum unit for engineering units such as °C, m, and g.

The size of EU varies according to the input type. For example, when the input temperature setting range is -200 to $+1300^{\circ}\text{C}$, 1 EU is 1°C , and when the input temperature setting range is -20.0 to $+500.0^{\circ}\text{C}$, 1 EU is 0.1°C .

In the case of analog input, the size of EU varies according to the decimal point position of the scaling setting, and 1 EU becomes the minimum scaling unit.

■ How to Read Display Symbols

The following tables show the correspondence between the symbols displayed on the displays and alphabet characters.

A	b	C	d	E	F	G	H	I	J	K	L	M
A	B	C	D	E	F	G	H	I	J	K	L	M

n	ö	P	q	r	S	t	U	v	y	ü	y	z
N	O	P	Q	R	S	T	U	V	W	X	Y	Z

■ “Reference” mark

This mark indicates that extra, useful information follows, such as supplementary explanations and how to apply functions.



■ How This Manual is Organized

Purpose	Related title	Description
● Learning about the E5GN	Chapter 1 INTRODUCTION	This chapter describes the features, names of parts and typical functions.
● Setting up	Chapter 2 PREPARATIONS	This chapter describes installation and wiring.
● Basic operations	Chapter 3 BASIC OPERATION and Chapter 5 PARAMETERS	These chapters describe basic control examples.
● Applied operations	Chapter 4 APPLIED OPERATION and Chapter 5 PARAMETERS	These chapters describe advanced functions to fully use the E5GN.
● Calibration	Chapter 6 CALIBRATION	This chapter describes calibration method.
● Appendix		This chapter describes the unit specifications. There is also a parameter operations list to be used as a backup guide to the parameter settings.

Table of Contents

	Preface	I
	Precautions	II
	Safety Precautions	III
	Notice	IV
	Conventions Used in This Manual	V
CHAPTER 1	INTRODUCTION	1-1
1.1	Names of Parts	1-2
	Front panel	1-2
	Display	1-2
	How to use keys	1-3
1.2	I/O Configuration and Main Functions	1-4
	I/O configuration	1-4
	Main functions	1-5
1.3	How Setup Levels Are Configured and Operating the Keys on the Front Panel	1-6
	Selecting parameters	1-8
	Fixing settings	1-8
1.4	Communications Function	1-9
CHAPTER 2	PREPARATIONS	2-1
2.1	Installation	2-2
	Dimensions	2-2
	Panel cutout	2-2
	Mounting	2-3
	Removing and attaching the terminal plate	2-3
2.2	Wiring Terminals	2-4
	Terminal arrangement	2-4
	Precautions when wiring	2-4
	Wiring	2-4
2.3	Requests at Installation	2-7
	To ensure prolonged use	2-7
	To reduce the influence of noise	2-7
	To ensure high-precision measurement	2-7
	About waterproofing	2-8
CHAPTER 3	BASIC OPERATION	3-1
3.1	Initial Setup Examples	3-2
3.2	Setting the Input Type	3-4
	Input type	3-4
3.3	Selecting °C/°F	3-5
	Temperature unit	3-5
3.4	Selecting PID Control or ON/OFF Control	3-6
3.5	Setting Output Specifications	3-7
	Control period	3-7
	Direct/reverse operation	3-7

3.6	Setting the SP	3-9
	Changing the SP	3-9
3.7	Executing ON/OFF Control	3-10
	ON/OFF control	3-10
	Setup	3-11
3.8	Determining PID Constants (AT, ST, manual setup)	3-12
	AT (auto-tuning)	3-12
	ST (self-tuning)	3-13
	Manual setup	3-15
3.9	Alarm Output	3-17
	Alarm type	3-18
	Alarm value	3-19
3.10	Requests during Operation	3-20
 CHAPTER 4 APPLIED OPERATION		4-1
4.1	Shifting Input Values	4-2
	Shifting input	4-2
	How to calculate input shift values (2-point shift)	4-3
	1-point shift method	4-4
	2-point shift method	4-4
	Example of 2-point temperature input shift	4-5
4.2	Alarm Hysteresis	4-6
	Standby sequence	4-6
	Alarm latch	4-6
	Close in alarm/open in alarm	4-7
4.3	Setting Scaling Upper and Lower Limits (analog input)	4-8
	Analog input	4-8
4.4	Executing Heating and Cooling Control	4-9
	Heating and cooling control	4-9
	Setup	4-10
4.5	Setting Multi-SP	4-11
	Setting the SP by key operation	4-11
	Setup	4-11
4.6	Setting the SP Upper and Lower Limit Values	4-13
	Set point limiter	4-13
	Setup	4-14
4.7	Executing the SP Ramp Function (limiting the SP change rate)	4-15
	SP ramp	4-15
4.8	To Move to the Advanced Function Setting Level	4-17
4.9	Using the Key Protect level	4-18
	Key protect	4-18
 CHAPTER 5 PARAMETERS		5-1
	Conventions Used in this Chapter	5-2
	Protect Level	5-3
	Operation Level	5-4
	Adjustment Level	5-10
	Initial Setting Level	5-17

Advanced Function Setting Level	5-25
Communications Setting Level	5-36
CHAPTER 6 CALIBRATION	6-1
6.1 Parameter Structure	6-2
6.2 User Calibration	6-3
6.3 Calibrating Thermocouples	6-4
6.4 Calibrating Analog Input	6-7
6.5 Calibrating Platinum Resistance Thermometers	6-8
6.6 Checking Indication Accuracy	6-9
APPENDIX	A-1
SPECIFICATIONS	A-2
Ratings	A-2
Characteristics	A-3
ERROR DISPLAY	A-4
PARAMETER OPERATIONS LIST	A-6
SENSOR INPUT SETTING, INDICATION AND CONTROL RANGES	A-10
SETUP LEVELS DIAGRAM	A-11
PARAMETER FLOW	A-12

CHAPTER 1

INTRODUCTION

1.1	Names of Parts	1-2
	Front panel	1-2
	Display	1-2
	How to use keys	1-3
1.2	I/O Configuration and Main Functions ...	1-4
	I/O configuration	1-4
	Main functions	1-5
1.3	How Setup Levels Are Configured and Operating the Keys on the Front Panel ...	1-6
	Selecting parameters	1-8
	Fixing settings	1-8
1.4	Communications Function	1-9

1.1 Names of Parts

■ Front panel

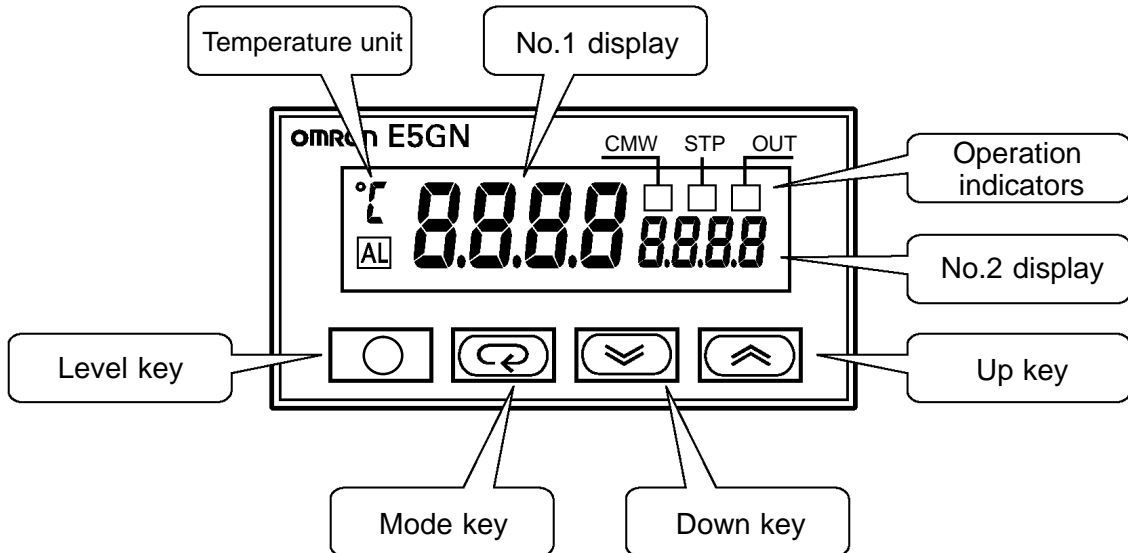







■ Display

- **No.1 display** Displays the process value or parameter type.
Lights for approximately one second during startup.
- **No.2 display** Displays the set point, parameter operation read value or the manipulated variable.
Lights for approximately one second during startup.
- **Operation indicators**
 - (1) AL (alarm)
Lights when alarm is ON.
 - (2) CMW (communications writing control)
Lights when communications writing is “enabled” and is out when it is “disabled.”
 - (3) STP (stop)
Lights when control of the E5GN has been stopped.
During control, this indicator lights when the run/stop function has been stopped.
 - (4) OUT (control output 1, control output 2)
Lights when control output 1, or control output 2 is ON.
- **Temperature unit** The temperature unit is displayed when the display unit parameter is set to a temperature. Indication is determined by the currently selected “temperature unit” parameter set value. When this parameter is set to “°C”, “°C” is displayed, and when set to “°F”, “°F” is displayed.
Flashes during ST operation.

■ How to use keys

The following describes the basic functions of the front panel keys.

-  (level) key
Press this key to select the setting levels. The setting level is selected in order “operation level” ↔ “adjustment level” and “initial setting level” ↔ “communications setting level”.
-  (mode) key
Press this key to select parameters within each level.
-  (up) key
Each press of this key increments values displayed on the No.2 display. Holding down this key continuously increments values.
-  (down) key
Each press of this key decrements values displayed on the No.2 display. Holding down this key continuously decrements values.
-  +  key combination
This key combination sets the E5GN to the “protect mode”. For details on the protect level, see Chapter 5 parameters.

1.2 I/O Configuration and Main Functions

■ I/O configuration

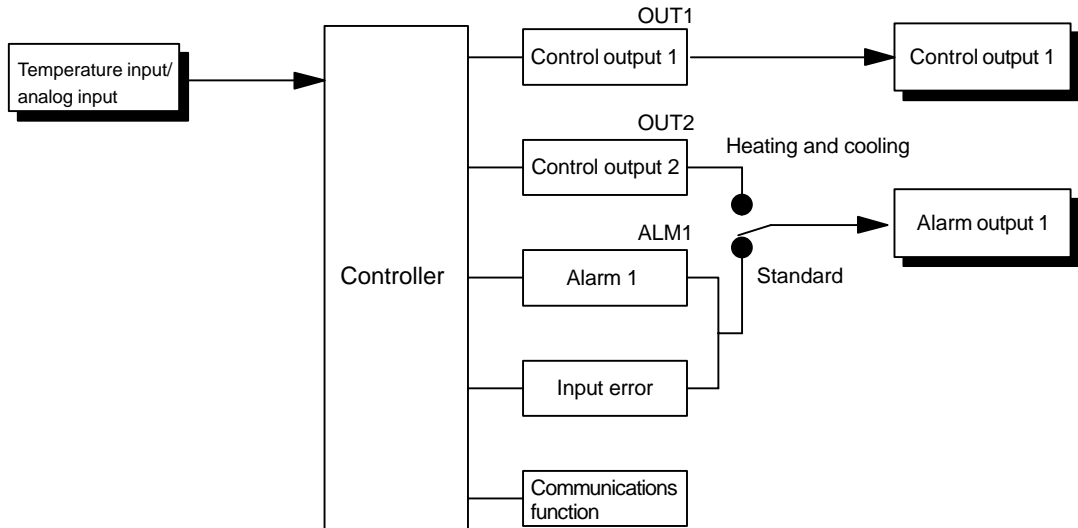

1.3 How Setup Levels Are Configured and Operating the Keys on the Front Panel

Parameters are divided into groups, each called a “level”. Each of the set values (setup items) in these levels is called a “parameter.” The parameters on the E5GN are divided into the following seven levels: When the E5GN is turned ON, all items in the display light for about one second.

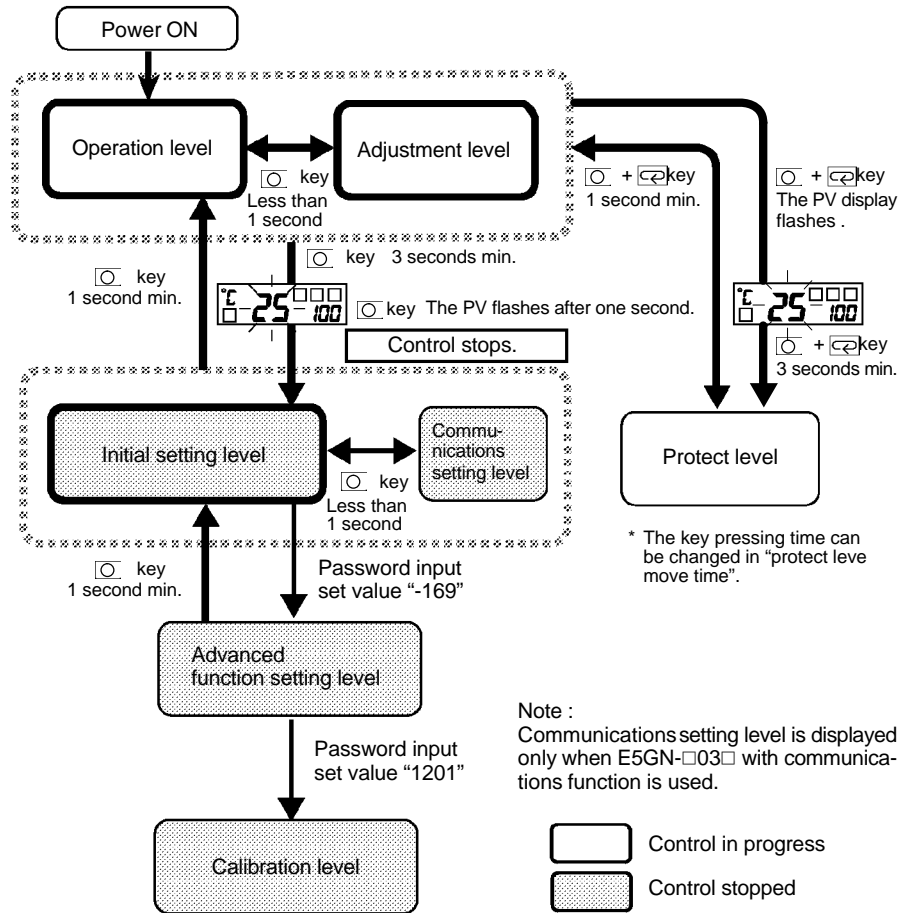

Note : Communications setting level is displayed only when E5GN-□03□ with communications function is used.

	Control in Progress	Control Stopped
Protect level	○	-
Operation level	○	-
Adjustment level	○	-
Initial setting level	-	○
Advanced function setting level	-	○
Calibration level	-	○
Communications setting level	-	○

○ : Indicates items that can be set.

Of these levels, the initial setting level, communications setting level, advanced function setting level and calibration level can be used only when control has stopped. Note that the controller outputs are stopped when these four levels are selected.



- **Protect level**
 - To move the mode at this level, simultaneously press the and keys for at least three seconds in the operation level or adjustment level. This level is for preventing unwanted or accidental modification of parameters. Protected levels will not be displayed, and so the parameters in that level cannot be modified.
 - * The key pressing time can be changed in “protect level move time”.
- **Operation level**
 - This level is displayed when you turn the power ON. You can move to the protect level, initial setting level and adjustment level from this level.
 - Normally, select this level during operation. During operation, the process value, set point and manipulated variable can be monitored, and the alarm value and upper- and lower-limit alarms can be monitored and modified.
- **Adjustment level**
 - To move the mode at this level, press the key for less than one second.
 - This level is for entering set values and offset values for control. This level contains parameters for setting the AT (auto-tuning), communications writing enable/disable, hysteresis, multi-SP, input shift values and PID constants. You can move to the top parameter of the initial setting level, protection level and operation level from here.
- **Initial setting level**
 - To move the mode at this level, press the key for at least three seconds in the operation level or adjustment level. The PV display flashes after one second.
 - This level is for specifying the input type, selecting the control method, control period, setting direct/reverse action and alarm type. (When you move to the operation level from the initial setting level, all items in the display light.)
 - You can move to the advanced function setting level or communications setting level from this level. To return to the operation level, press the key for at least one second. To move to the communication setting level, press the key for less than one second.
- **Advanced function setting level**
 - To move the mode at this level, after setting the “Initial/communications protection” of the “Protection level” to 0, input the password (“-169”) in the initial setting level.
 - You can move to the calibration level or initial level from this level.
 - This level is for setting the automatic return of display mode, MV limiter, standby sequence, alarm hysteresis, ST (self-tuning) and for moving to the user calibration level.
- **Communications setup level**
 - To move the mode at this level, press the key for less than one second in the initial setting level.
 - When the communications function is used, set the communications conditions in this level. Communicating with a personal computer (host computer) allows set points to be read and written, and manipulated variables to be monitored.

NOTE This level is available only on the E5GN-□03□.

● Calibration level





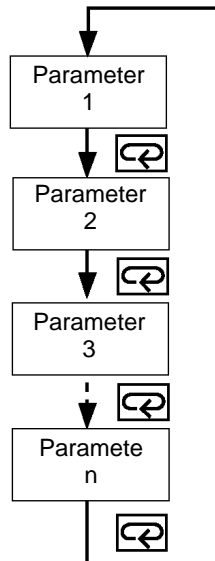

- To move the mode at this level, you must enter the password “1201” in the advanced function setting level. This level is for offsetting deviation in the characteristics on the input circuit.
- You cannot move to other levels by operating the keys on the front panel from the calibration level. To cancel this level, turn the power OFF then back ON again.

■ Selecting parameters

- To select parameters in each level, press the  key. Each press of the  key advances to the next parameter. For details on each parameter, see Chapter 5.







■ Fixing settings

- If you press the  key at the final parameter, the display returns to the top parameter for the current level.
- To change parameter settings or setup, specify the setting using the  or  keys, and either leave the setting for at least two seconds or press the  key. This fixes the setting.
- When another level is selected, the parameter and setting on the display are fixed.
- When you turn the power OFF, you must first fix the settings or parameter setup (by pressing the  key or selecting another mode). The settings and parameter setup are sometimes not changed by merely pressing the  or  keys.

1.4 Communications Function

The E5GN can be provided with a communications function that allows you to check and set controller parameters on a host computer. If the communications function is required, use the model supporting the communications function E5GN-□03□. For details on the communications function, see the separate “Communications Functions User’s Manual.” Follow the procedure below to move to the communication setting level.

- (1) Press the  key for at least three seconds in the “operation level”. The level moves to the “initial setting level”.
- (2) Press the  key for less than one second. The “initial setting level” moves to the “communications setting level”.
- (3) Pressing the  key advances the parameters as shown in the following figure.
- (4) Press the  or  keys to change the parameter setups.

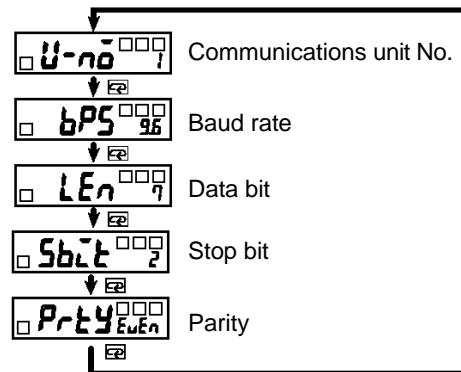

● Setting up communications data

Set the E5GN communications specifications so that they match the communications setup of the host computer. In the case of a one-to-N connection, match the communications setup of all units.

Parameter	Symbol	Setting	Set value	Default	Unit
Communications unit No.	U-nō	0 to 99		1	None
Baud rate	bPS	1.2, 2.4, 4.8, 9.6, 19.2	12, 24, 48, 96, 192	9.6	kbps
Data bit	LEN	7, 8		7	Bit
Stop bit	Sbct	1, 2		2	Bit
Parity	Prty	None, even, odd	nōnE, EueE, odd	Even	None

CHAPTER 2

PREPARATIONS

2.1	Installation	2-2
	Dimensions	2-2
	Panel cutout	2-2
	Mounting	2-3
	Removing and attaching the terminal plate	2-3
2.2	Wiring Terminals	2-4
	Terminal arrangement	2-4
	Precautions when wiring	2-4
	Wiring	2-4
2.3	Requests at Installation	2-7
	To ensure prolonged use	2-7
	To reduce the influence of noise	2-7
	To ensure high–precision measurement ..	2-7
	About waterproofing	2-8

2.1 Installation

■ Dimensions

● E5GN

• External dimensions (Unit: mm)

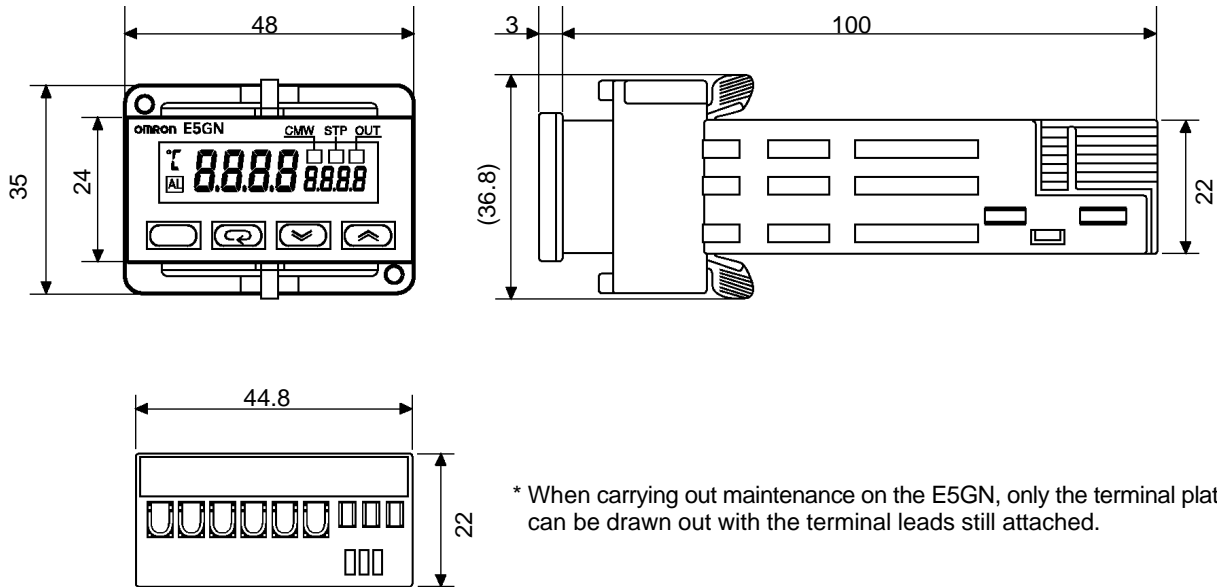

* When carrying out maintenance on the E5GN, only the terminal plate can be drawn out with the terminal leads still attached.

■ Panel cutout

When mounted separately (unit : mm)

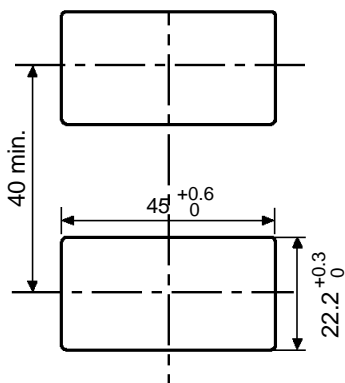

When group-mounted (unit: mm)

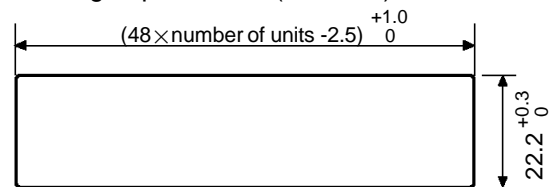

Waterproofing is not possible when ground mounting several units.

- The recommended panel thickness is 1 to 5 mm.
- Several units cannot be ground mounted close together vertically. (Observe the recommended mounting space limits.)
- When two or more E5GNs are mounted, make sure that the surrounding temperature does not exceed the allowable operating temperature given in the specifications.

■ Mounting

- (1) To ensure waterproofing, enclose the unit in the waterproof packing prior to mounting. Waterproofing is not possible when ground mounting several units.
- (2) Insert the E5GN into the mounting hole in the panel from the front.
- (3) Push the adapter along the E5GN body from the terminals up to the panel, and fasten temporarily.
- (4) Tighten the two fixing screws on the adapter. When tightening screws, tighten the two screws alternately keeping the torque to within approximately 0.29 to 0.39 N·m.

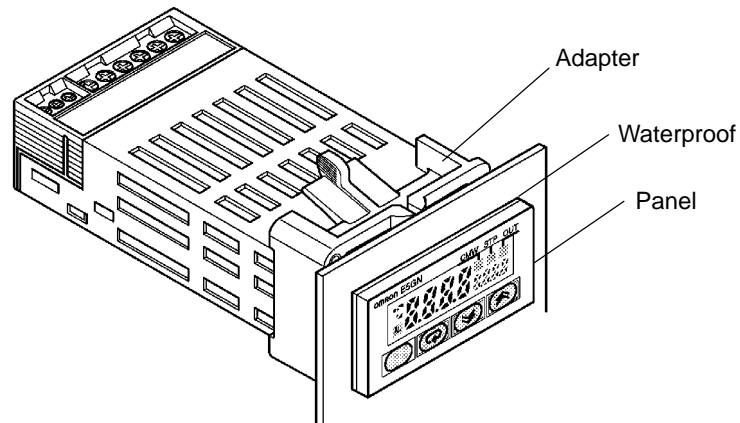

■ Removing and attaching the terminal plate

The E5GN can be replaced by removing the terminal plate.

- (1) Press down hard on the fasteners on both sides of the terminals to unlock the terminal plate and pull upwards.

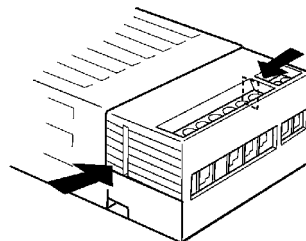

- (2) Draw out the terminal plate as it is.

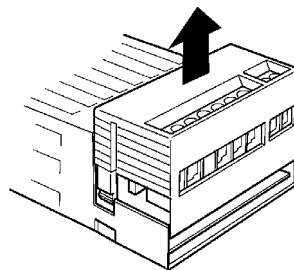

- (3) Before you insert the terminal plate again, make sure that the pins match the positions of the holes in the terminal plate.

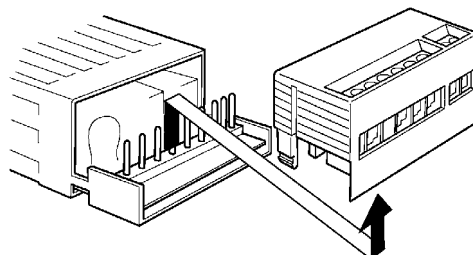

2.2 Wiring Terminals

Terminal arrangement

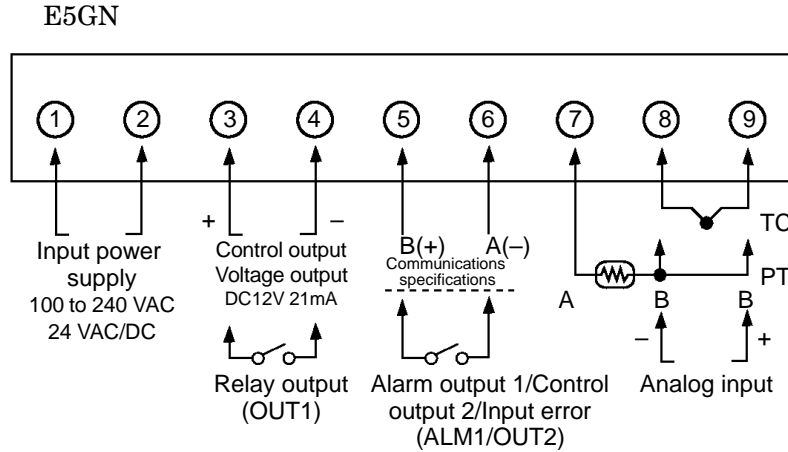

Precautions when wiring

- Separate input leads and power lines in order to protect the controller and its lines from external noise.
- Use AWG24 to AWG14 leads for terminal Nos.1 to 6 and AWG28 to AWG22 leads for terminal Nos.7 to 9.
- Tighten the terminal screws using a torque no greater than 0.24 N·m (2.5kgf·cm) for terminal Nos.1 to 6, and a torque no greater than 0.13 N·m (1.4kgf·cm) for terminal Nos.7 to 9.

Wiring

● Power supply

- Connect to terminal Nos.1 and 2. The power supply specifications are as follows:
 100 to 240 VAC, 50/60 Hz, 7 VA
 or
 24 VAC, 50/60 Hz, 4 VA
 24 VDC, 2.5 W (no polarity)
- Standard insulation is applied to the power supply I/O sections. If reinforced insulation is required, connect the input and output terminals to a device without any exposed current-carrying parts or to a device with standard insulation suitable for the maximum operating voltage of the power supply I/O section.

● Input

- Connect to terminal Nos.7 to 9 as follows according to the input type.

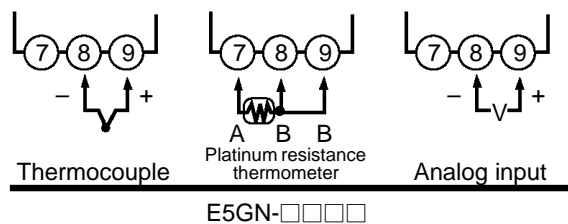

● Control output 1

- Terminal Nos.3 and 4 are for control output. The following diagram shows the available outputs and their internal equalizing circuits.

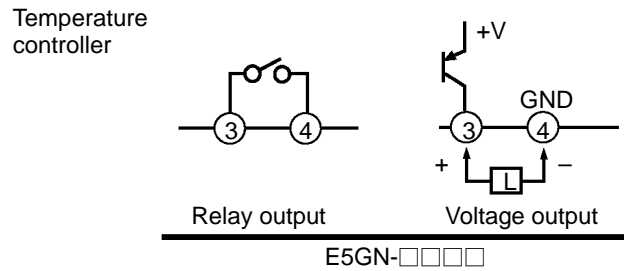

- The following table shows the specifications for each output unit.

Output type	Specifications
Relay	250 VAC, 2A, electrical life: 100,000 operations
Voltage (PNP)	PNP type, 12 VDC, 21 mA (with short-circuit protection)

- The voltage output (control output) is not electrically insulated from the internal circuits. When using a grounding thermocouple, do not connect the control output terminals to the ground. If the control output terminals are connected to the ground, errors will occur in the measured temperature values as a result of leakage current.

● Alarm output 1/ control output 2

- On the E5GN-□1□, alarm output 1 (ALM1) is across terminal Nos.5 and 6.

The following diagram shows the internal equalizing circuits for alarm output 1.

- When utilizing heating and cooling control, alarm output 1 becomes alarm output 2.
- When the input error output is set to “ON”, alarm output 1 turns ON when an input error occurs.

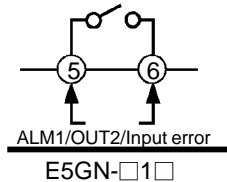

- Relay specifications are as follows:
SPST-NO, 250 VAC, 1 A

● **Communications**

- When carrying out communications on the E5GN-□03□, connect the communications cable across terminal Nos.5 and 6.

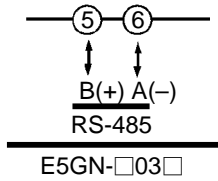

Communications Unit Wiring Diagram

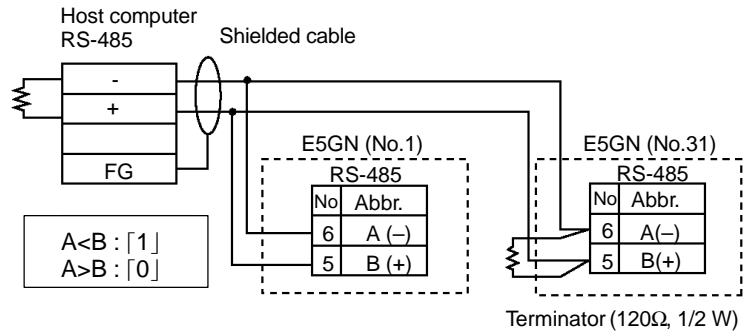

- The RS-485 connection can be either one-to-one to one-to-N. Up to 32 units including the host computer can be connected in one-to-N systems. Use shielded, twisted pair cable (AWG 24 to AWG 14), and keep the total cable length to 500 m.
- Specify both ends of the transmission path including the host computer as the end node (that is, connect terminators to both ends). The maximum terminal resistance is 54 Ohms.

2.3 Requests at Installation

■ To ensure prolonged use

Use the temperature in the following operating environment:

Temperature : -10 to $+55^{\circ}\text{C}$ (icing and condensation not allowed)

Humidity : 25 to 85%

When the temperature controller is incorporated in a control panel, make sure that the controller's ambient temperature and not the panel's ambient temperature does not exceed 55°C .

The life of electronic equipment such as temperature controllers is influenced not only by the life determined by the relay switching count but also by the life of the electronic components used internally. The service life of components is dependent on the ambient temperature: the higher the ambient temperature becomes, the shorter the service life becomes, and vice versa. For this reason, the service life of the temperature controller can be extended by lowering its internal temperature.

Gang-mounting two or more temperature controllers, or mounting temperature controllers above each other may cause heat to build up inside the temperature controllers, which will shorten their service life. When mounting temperature controllers like this, forced cooling measures such as a cooling fan for cooling the temperature controllers must be taken into consideration. Prevent only the terminal block from being cooled. Otherwise, this may result in a measurement error.

■ To reduce the influence of noise

To reduce induction noise, the leads on the temperature controller's terminal block must be wired separately from large-voltage/large-current power leads. Also, avoid wiring leads in parallel with power leads or in the same wiring path. Other methods such as separating conduits and wiring ducts, or using shield wire are also effective.

Attach a surge absorber or noise filter to peripheral equipment that generates noise (in particular, motors, transformers, solenoids, or other equipment that has a magnetic coil or other inductance component).

When a noise filter is used at the power supply, first check the voltage or current, and attach the noise filter as close as possible to the temperature controller.

Also, install the temperature controller as far away as possible from equipment that generates strong, high frequency (e.g. high-frequency welders, high-frequency sewing machines) or surges.

■ To ensure high-precision measurement

When the thermocouple leads are extended, be sure to use a compensating lead wire matched to the type of thermocouple.

When the platinum resistance detector leads are extended, use the lead having the smallest resistance to equalize the resistance of the three leads. Install the temperature controller so that it is horizontal.

If there is a large error in the measurement values, make sure that input compensation has been set correctly.

■ About waterproofing

The protective structure of this controller conforms to the following standards. Parts that are not indicated as being protected or that are indicated as IP□0 are not waterproof.

Front panel: NEMA4X NEMA4X for indoor use (equivalent to IP66)

Rear case: IP20



Terminals: IP00

CHAPTER 3

BASIC OPERATION

3.1	Initial Setup Examples	3-2
3.2	Setting the Input Type	3-4
	Input type	3-4
3.3	Selecting °C/°F	3-5
	Temperature unit	3-5
3.4	Selecting PID Control or ON/OFF Control	3-6
3.5	Setting Output Specifications	3-7
	Control period	3-7
	Direct/reverse operation	3-7
3.6	Setting the SP	3-9
	Changing the SP	3-9
3.7	Executing ON/OFF Control	3-10
	ON/OFF control	3-10
	Setup	3-11
3.8	Determining PID Constants (AT, ST, manual setup)	3-12
	AT (auto-tuning)	3-12
	ST (self-tuning)	3-13
	Manual setup	3-15
3.9	Alarm Output	3-17
	Alarm type	3-18
	Alarm value	3-19
3.10	Requests during Operation	3-20

3.1 Initial Setup Examples

On previous controllers, sensor input type, alarm type and control period were set by the DIP switches. These hardware settings are now set in parameters in setup menus. The  and  keys are used to switch between setup menus, and the amount of time that you hold the keys down for determines which setup menu you move to. This section describes two typical examples.

● **Typical example 1**

Input type	: 0 K thermocouple -200 to 1300°C
Control method	: ON/OFF control
Alarm type	: 2 upper limit
Alarm value 1	: 20°C (deviation)
Set point	: 100°C

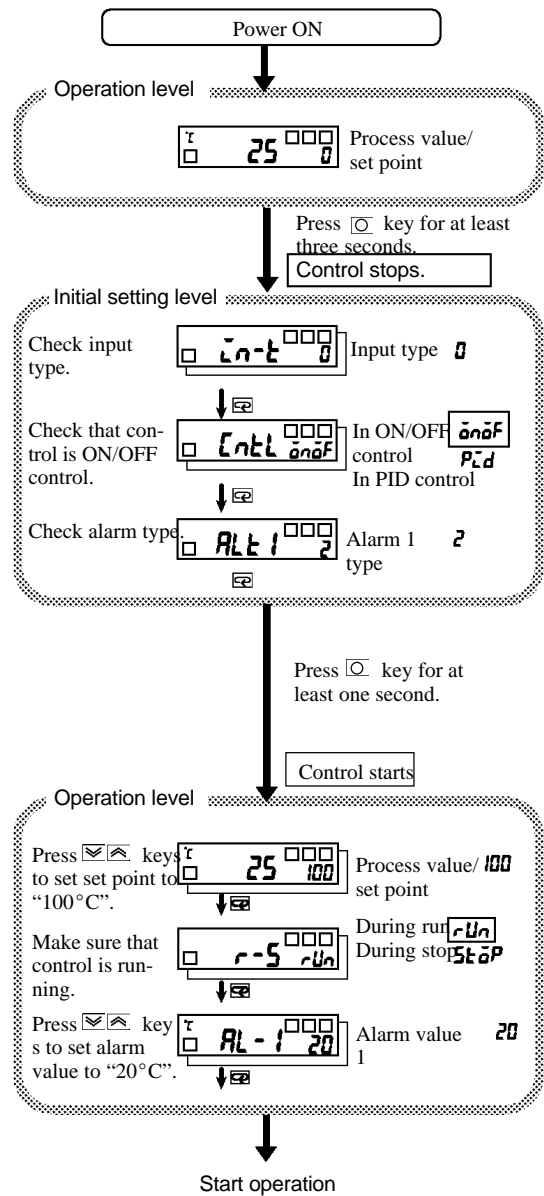
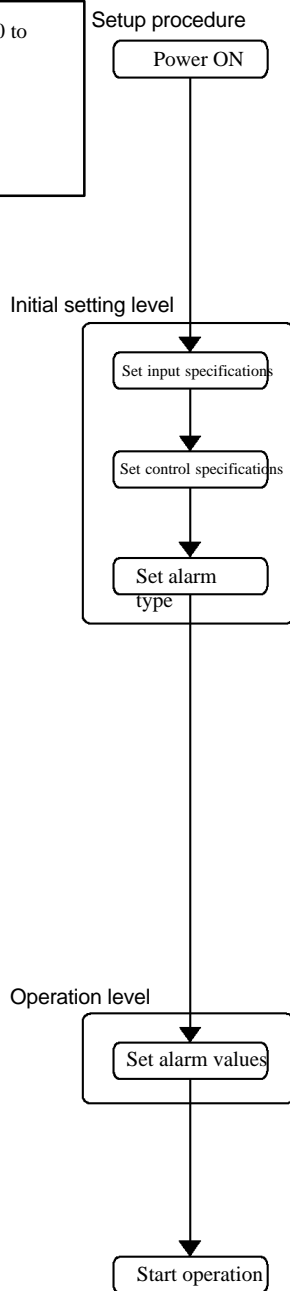

● Typical example 2

Input type : 4 T thermocouple -200 to 400°C
Control method: PID control
ST (self-tuning) : OFF
Calculate PID constants by AT (auto-tuning) execution.
Alarm type : 2 upper limit
Alarm value 1 : 30°C (deviation)
Set point : 150°C

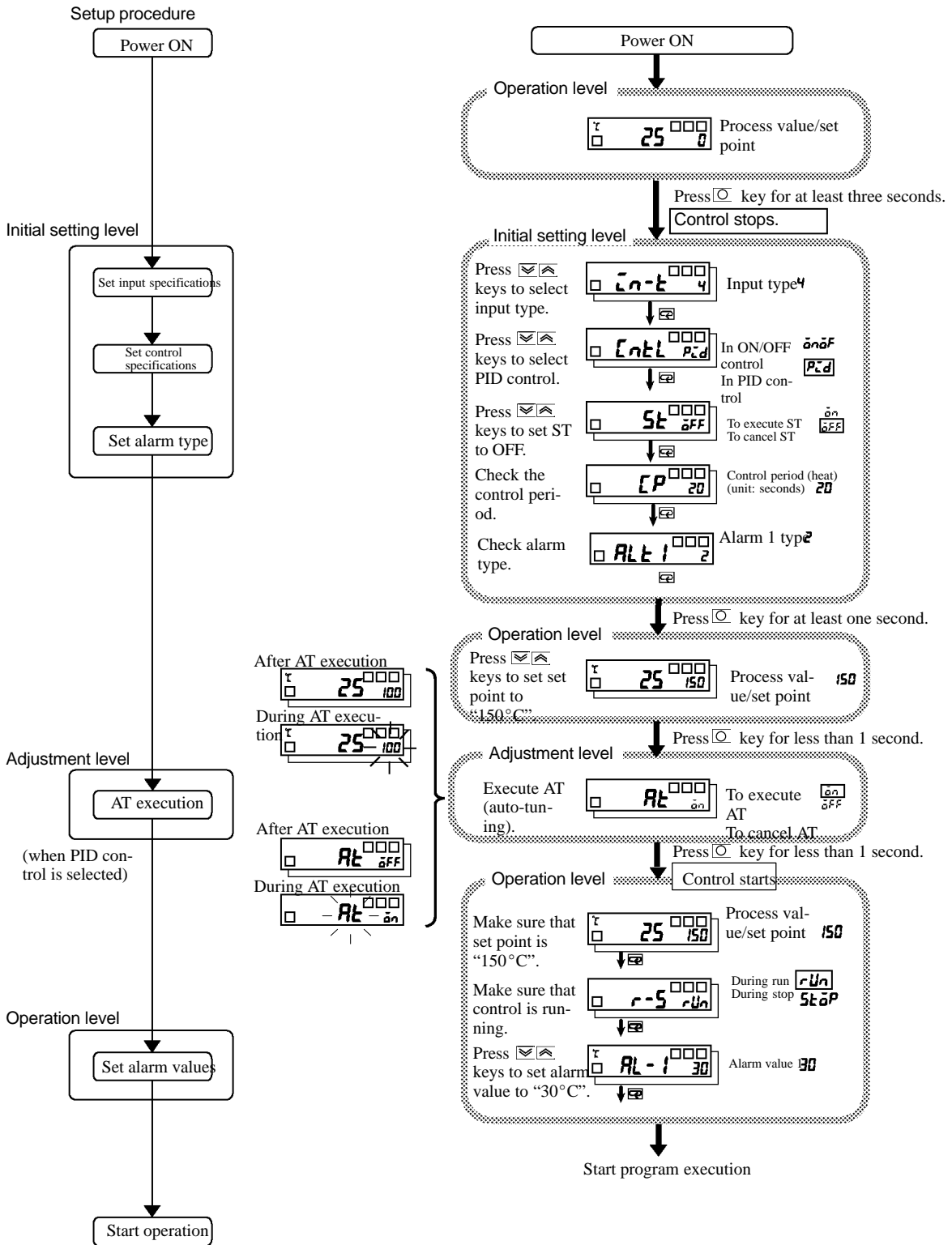

3.2 Setting the Input Type

The E5GN supports four input types: platinum resistance, thermocouple, non-contact temperature sensor and analog inputs. Set the input type matched to the sensor connected to the E5GN in the “input type” parameter. The E5GN specifications support two types of inputs, platinum resistance thermometer and “non-contact temperature sensor, thermocouple and analog input,” whose set values differ. Check the type of E5GN at purchase.

Input type

Operation Procedure

Operation level



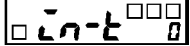

Initial setting level



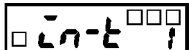

Input type



Setting the input type “thermocouple K-20.0 to 500.0°C”.

- (1) Press the  key for at least three seconds to move from the “operation level” to the “initial setting level”.
- (2) Press the  key to enter the set value of the desired sensor. When you use K thermocouple (-20.0 to 500.0°C), enter “1” as the set value.

Hint: The set value is fixed if you do not operate the keys on the front panel for two seconds after changing the parameter, or by pressing the  or  keys.

List of Input Types

	Input type	Name	Set Value	Input Temperature Setup Range
Platinum resistance thermometer input type	Platinum resistance thermometer	Pt100	0	-200 to 850 (°C) / -300 to 1500 (°F)
			1	-199.9 to 500.0 (°C) / -199.9 to 900.0 (°F)
		JPt100	2	0.0 to 100.0 (°C) / 0.0 to 210.0 (°F)
			3	-199.9 to 500.0 (°C) / -199.9 to 900.0 (°F)
			4	0.0 to 100.0 (°C) / 0.0 to 210.0 (°F)
Thermocouple input type	Thermocouple	K	0	-200 to 1300 (°C) / -300 to 2300 (°F)
			1	-20.0 to 500.0 (°C) / 0.0 to 900.0 (°F)
		J	2	-100 to 850 (°C) / -100 to 1500 (°F)
			3	-20 to 400.0 (°C) / 0.0 to 750.0 (°F)
		T	4	-200 to 400 (°C) / -300 to 700 (°F)
			17	-199.9 to 400.0 (°C) / -199.9 to 700.0 (°F)
		E	5	0 to 600 (°C) / 0 to 1100 (°F)
		L	6	-100 to 850 (°C) / -100 to 1500 (°F)
		U	7	-200 to 400 (°C) / -300 to 700 (°F)
			18	-199.9 to 400.0 (°C) / -199.9 to 700.0 (°F)
		N	8	-200 to 1300 (°C) / -300 to 2300 (°F)
	R	9	0 to 1700 (°C) / 0 to 3000 (°F)	
	S	10	0 to 1700 (°C) / 0 to 3000 (°F)	
	B	11	100 to 1800 (°C) / 300 to 3200 (°F)	
	Non-contact temperature sensor ES1A	10 to 70°C	12	0 to 90 (°C) / 0 to 190 (°F)
			13	0 to 120 (°C) / 0 to 240 (°F)
14			0 to 165 (°C) / 0 to 320 (°F)	
15			0 to 260 (°C) / 0 to 500 (°F)	
Analog input	0 to 50mV	16	One of the following ranges depending on the results of scaling: -1999 to 9999, -199.9 to 999.9	

Shaded ranges indicate default settings.

3.3 S Selecting °C/°F

■ Temperature unit

- Select either “°C” or “°F” as the temperature unit.
- Set the temperature unit in the “temperature unit” parameter of “initial setting level”. Default is “ C : °C”.

Operation Procedure

Operation level

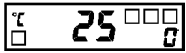

Initial setting level



Input type

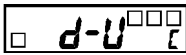

Temperature unit

Select “°C”

- (1) Press the key for at least three seconds to move from the “operation level” to the “initial setting level”.
- (2) Select the “temperature unit” parameter by pressing the key. Press the or keys to select either “°C” or “°F”.
 $\text{C} : \text{°C}$ $\text{F} : \text{°F}$
- (3) To return to the “operation level” press the key for at least one second.

3.4 Selecting PID Control or ON/OFF Control

The E5GN supports two control methods, 2-PID control and ON/OFF control. The control method is selected by the “PID / ON/OFF” parameter in the “initial setting level”. When this parameter is set to “PID”, 2-PID control is set, and when set to “ON/OFF”, ON/OFF control is set (default).

● 2-PID control

PID control is set by AT (auto-tuning), ST (self-tuning) or manual setup. For PID control, set the PID constants in the “proportional band (P)”, “integral time (I)” and “derivative time (D)” parameters.

● ON/OFF control

In “ON/OFF” control, the control output is turned ON when the process value is lower than the current set point, and the control output is turned OFF when the process value is higher than the current set point (reverse operation).

3.5 Setting Output Specifications

Control period



- Set the output period (control period). Though a shorter period provides better control performance, we recommend setting the control period to 20 seconds or more taking the life expectancy in the case of relay output into consideration. If necessary, readjust the control period by trial operation, for example, when the control period parameters are set to their defaults.
- Set the control period in the “control period (OUT1)” parameter (initial setting level). Default is “20 seconds”.

Direct/reverse operation



- “Direct operation” refers to control where the manipulated variable is increased according to the increase in the process value. Alternatively, “reverse operation” refers to control where the manipulated variable is decreased according to the increase in the process value.

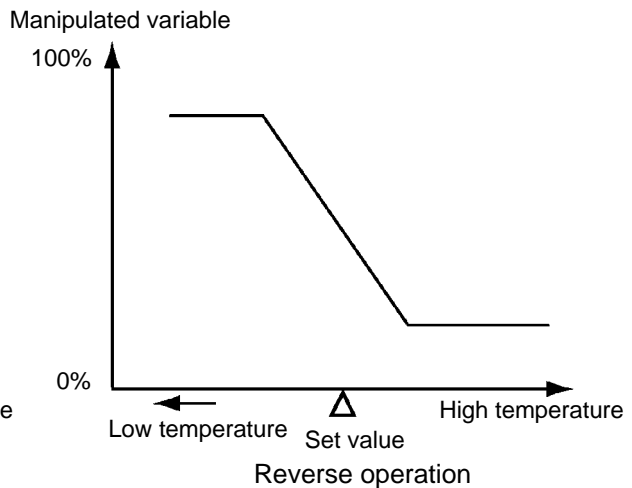
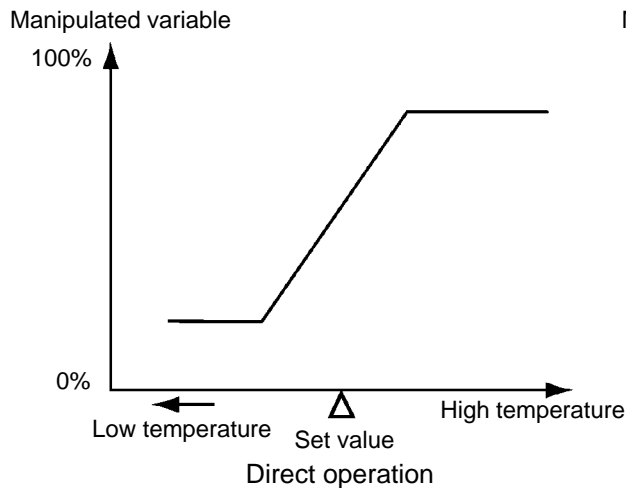

For example, when the process value (PV) (temperature) is lower than the set point (SP) (temperature) in a heating control system, the manipulated variable increases by the difference between the PV and SP values.

Accordingly, this becomes “reverse operation” in a heating control system, or alternatively, “direct operation” in a cooling control system.

- Direct/reverse operation is set in the “direct/reverse operation” parameter (initial setting level). The “direct/reverse operation” parameter default is “reverse operation”.

Operation Procedure

In this example, let's monitor the "input type", "temperature unit", "direct/reverse operation" and "control period (heat)" parameters.

"input type" = "0": K thermocouple

"temperature unit" = "C": °C

"direct/reverse operation" = "rr": reverse operation

"control period (OUT1)" = "20 (secs)"

Operation level
 PV/SP









Initial setting level
 Input type

 Temperature unit

 Control period (OUT1)

 Direct/reverse operation

Operation level
 PV/SP

- (1) Press the  key for at least three seconds to move from the "operation level" to the "initial setting level".
- (2) The input type is displayed. When you are setting the input type for the first time, "0": K thermocouple is set. ("0" is set in the case of a platinum resistance thermometer.) To select a different sensor, press the  or  keys.
- (3) Select the "temperature unit" parameter by pressing the  key. Default is "C": °C. To select "F": °F, press the  key.
- (4) Select the "control period (OUT1)" parameter by pressing the  key. Default is "20".
- (5) Select the "direct/reverse operation" parameter by pressing the  key. Default is "rr": reverse operation. To select "rd": direct operation, press the  key.
- (6) To return to the "operation level" press the  key for at least one second.

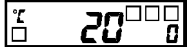

3.6 Setting the SP

Operation level



The “operation level” is displayed when the E5GN is turned ON. The left display (No.1 display) displays the process value, and the right display (No.2 display) displays the set point.

■ Changing the SP



- The set point cannot be changed when the “operation/adjustment protection” parameter is set to “3”. For details, see “4.8 Using the Key Protect Levels.”
- To change the set point, press the  or  keys in the “PV/SP” parameter (operation level), and set the desired set value. The new set point is selected two seconds after you have specified the new value.

Operation Procedure

Operation level



In this example, let's change the set point from “0°C” to “200°C”.

- (1) Normally, the “PV/SP” parameter is displayed. The set point is “0°C”.
- (2) Press the  or  keys until the set point changes to “200°C”.



3.7 Executing ON/OFF Control

In “ON/OFF” control, the control output turns OFF when the currently controlled temperature reaches a preset set point. When the manipulated variable turns OFF, the temperature begins to fall and the control output turns ON again. This operation is repeated at a certain point. At this time, how much the temperature must fall before control turns ON again is determined by the “hysteresis (OUT1)” parameter. Also, how much the manipulated variable must be adjusted in response in the increase or decrease in the process value is determined by “direct/reverse operation” parameter.

■ ON/OFF control

- Switching between 2-PID control and ON/OFF control is carried out by the “PID / ON/OFF” parameter (initial setting level). When this parameter is set to “*PID*”, 2-PID control is selected, and when set to “*ON/OFF*”, ON/OFF control is selected. Default is “*ON/OFF*”.

● Hysteresis

- In ON/OFF control, the hysteresis is used as a differential for switching the output ON when the temperature moves away from the required set point, and is used to give stability around the set point.
- The hysteresis width is called the “hysteresis band.” The control output (OUT1) function is set by “hysteresis (OUT1).”
- In standard control (heating or cooling control), the “hysteresis (OUT1)” setting is used as the hysteresis setting in the adjustment level regardless of the control type, heating control or cooling control.

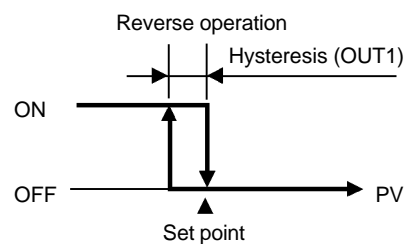

● 3-position control

- In heating and cooling control, a dead band (an area where both control outputs are “0”) can be set to either the heating or cooling side. So, 3-position control is made possible.

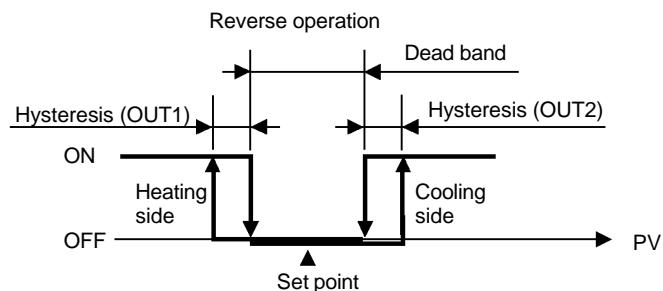

Parameters

Symbol	Parameter Name: Level	Description
S-HC	Standard/heating and cooling: Initial setting level	For specifying control method
ENTL	PID / ON/OFF: Initial setting level	For specifying control method
ORF	Direct/reverse operation: Initial setting level	For specifying control method
db	Dead band: Adjustment level	Heating and cooling control
SC	Cooling coefficient: Adjustment level	Heating and cooling control
HYS	Hysteresis (OUT1): Adjustment level	ON/OFF control
CHYS	Hysteresis (OUT2): Adjustment level	ON/OFF control

Setup

To execute ON/OFF control, set the “set point,” “PID / ON/OFF” and “hysteresis” parameters.

- Setting the PID / ON/OFF parameter

Operation Procedure

In this example, let’s first check that the “PID / ON/OFF” parameter is set to “ORF” in the “initial setting level”.

Operation level



Initial setting level

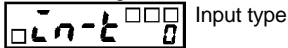

- (1) Press the key for at least three seconds to move from the “operation level” to the “initial setting level”.
- (2) The “input type” is the first parameter displayed when you have moved to the initial setting level.
- (3) Select the “PID / ON/OFF” parameter by pressing the key.
- (4) Check that the set value is “ORF” (default).
- (5) To return to the “operation level” press the key for at least one second.

Next, set the set point value.

- Setting the SP

Operation Procedure

In this example, set the set point value (200). The lower display (No.2 display) shows the set value (SP value).

Operation level

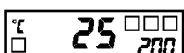

- (1) Select “PV/SP” at the operation level.
- (2) Use the keys to set the SP value. (For example, 200) To set the value either press the key or wait more than two seconds.

3.8 Determining PID Constants (AT, ST, manual setup)

■ AT (auto-tuning)



- When you execute auto-tuning, the optimum PID constants for the set point during program execution are automatically set by forcibly changing the manipulated variable to calculate the characteristics (called the “limit cycle method”) of the control target.
- To execute AT (auto-tuning), specify “ON : AT execute”, and to cancel AT (auto-tuning), specify “OFF : AT cancel”.
- AT (auto-tuning) cannot be executed during ON/OFF control or STOP.
- The result of AT (auto-tuning) is mirrored in the “proportional band (P)”, “integral time (I)” and “derivative time (D)” parameters in the “adjustment level”.

Adjustment level



● Description

AT (auto-tuning) is started when the “AT execute/cancel” parameter is set to “ON”. During execution of AT, the No.1 display for the “AT execute/cancel” parameter blinks. When AT ends, the “AT execute/cancel” parameter turns OFF, and the No.1 display stops blinking.



If you move to the “operation level” during AT execution, the No.2 display blinks to indicate that AT is being executed.



Only the “communications writing”, “run/stop” and “AT execution/cancel” parameters can be changed during AT execution. Other parameters cannot be changed.

Operation Procedure

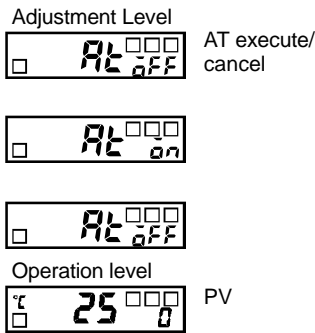

Execute auto-tuning (AT).

- (1) Press the key for less than one second to move from the “operation level” to the “adjustment level”.
- (2) Press the key to start execution of AT (auto-tuning). “ON” is displayed during AT execution.
- (3) “OFF” is displayed when AT ends.
- (4) To return to the “operation level,” press the key.

ST (self-tuning)



The ST (self-tuning) function executes tuning from the start of program execution to calculate the PID constants matched to the control target. Once the PID constants have been calculated, ST is not executed when the next control operation is started as long as the set point remains unchanged.

ST (self-tuning) is executed when the “ST” parameter is set to “ON” in the “initial setting level”.

When the ST function is in operation, be sure to turn the power supply of the load connected to the control output ON simultaneously with or before starting operation of the E5GN.

Execute self-tuning (ST).

Operation Procedure

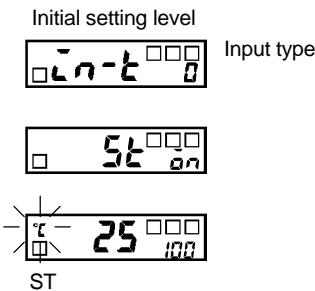

- (1) Press the key for at least three seconds to move from the “operation level” to the “initial setting level”.
- (2) Select the “ST” parameter by pressing the key.
- (3) Press the key to select “ON” (default).
- (4) To return to the “operation level,” press the key. The temperature display blinks during self-tuning (ST) execution.



About PID parameters

When control characteristics are already known, the PID constants can be set directly to adjust control.

PID parameters are set in the “proportional band” (P), “integrated time” (I) and “derivative time” (D) parameters in the “adjustment level”.

● ST start conditions

Self-tuning by step response tuning (SRT) is started when the following conditions are met after program execution is started and the set point is changed.

At Start of Program Execution	When Set Point Is Changed
<ol style="list-style-type: none"> 1. The set point at the start of program execution differs from the set point (See Note 1) when the previous SRT was executed. 2. The difference between the temperature at start of program execution is larger than (current proportional band \times 1.27+4°C) or the (ST stable range) whichever is larger. 3. The temperature at the start of program execution is smaller than the set point during reverse operation, and is larger than the set point during direct operation. 4. No reset from input error 	<ol style="list-style-type: none"> 1. The new set point differs from the set point (See Note 1) used when the previous SRT was executed. 2. The set point change width is larger than (current proportional band \times 1.27+4°C) or the (ST stable range) whichever is larger. 3. During reverse operation, the new set point is larger than the set point before the change; and during direct operation, the new set point is smaller than the set point before the change. 4. The temperature is in a stable state (See Note 2). (An equilibrium state is acceptable when the output is 0% when the power is turned ON.)

Note:

- (1) The previous SRT—implemented set point is called the set point obtained by calculating the PID constant by the previous SRT.
- (2) In this state, the measurement point is within the ST stable range.
- (3) In this state, the change width of the PV every 60 seconds is at the ST stable range or less.

PID constants are not modified for the currently preset set point by self-tuning (ST) in the following instances:

- (1) When the PID constants have been changed manually with ST set to ON.
- (2) When auto-tuning (AT) has been executed.

● ST stable range

Operation Procedure

The ST stable range is a condition for determining the conditions under which ST (self-tuning) functions.

In this example, let's set the ST stable range to 20°C.

Advanced function setting level

ST stable range

- (1) Select the “ST stable range” parameter by pressing the key in the “advanced function setting level”.

To move to this level, see “4.7 To Move to the Advanced Function Setting Level”.

- (2) Set to 20°C (deviation) using the key.

Manual setup

The individual PID constants can be manually set in the “Proportional band”, “Integral time” and “Derivative time” parameters in the “adjustment level”.

Operation Procedure

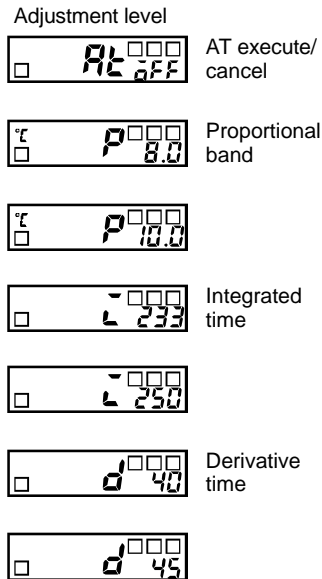

In this example, let's set the “proportional band” parameter to “10.0”, the “integrated time” parameter to “250” and the “derivative time” parameter to “45”.

- (1) Press the key to move from the “operation level” to the “adjustment level”.
- (2) Select “proportional band” by pressing the key.
- (3) Press the or key to set the parameter to “10.0”.
- (4) Select “integrated time” by pressing the key.
- (5) Press the or key to set the parameter to “250”.
- (6) Select “derivative time” by pressing the key.
- (7) Press the or key to set the parameter to “45”.
- (8) To return to the “operation level,” press the key.





Proportional Operation

When PID constants I (integral time) and D (derivative time) are set to “0”, control is executed according to proportional operation. The default set point becomes the center value of the proportional band.

Related parameter

“manual reset value” (adjustment level)

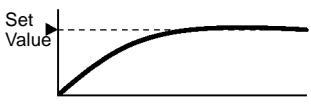
• When P (proportional band) is adjusted

When P is increased	 <p>The graph shows a process value starting from a lower level and rising smoothly to a horizontal dashed line labeled 'Set Value'. The curve levels off at the set point, indicating a long stable time without overshoot.</p>	The curve rises gradually, and a long stable time is achieved, preventing overshoot.
When P is decreased	 <p>The graph shows a process value starting from a lower level and rising quickly to a horizontal dashed line labeled 'Set Value'. It overshoots the set point, then oscillates around it before finally stabilizing at the set point.</p>	Overshoot and hunting occur, however the set point is quickly reached after which the curve stabilizes.

• When I (integral time) is adjusted

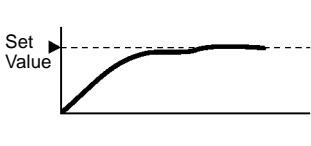
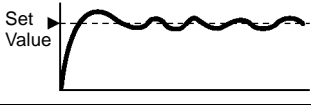
When I is increased	 <p>The graph shows a process value starting from a lower level and rising slowly to a horizontal dashed line labeled 'Set Value'. It reaches the set point with a long time delay but with very little overshoot or hunting.</p>	It takes a long time for the process value to reach the set point. It takes time to achieve a stable state, however there is little overshoot/undershoot and hunting.
When I is decreased	 <p>The graph shows a process value starting from a lower level and rising quickly to a horizontal dashed line labeled 'Set Value'. It overshoots the set point and then exhibits continuous oscillations (hunting) around the set point.</p>	Overshoot/undershoot and hunting occur, and the curve rises quickly.

• When D (derivative time) is adjusted

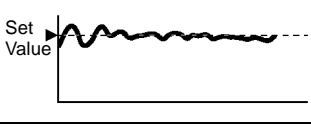
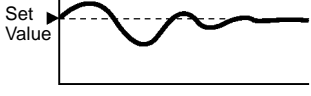
When D is increased	 <p>The graph shows a process value starting from a lower level and rising quickly to a horizontal dashed line labeled 'Set Value'. It reaches the set point with reduced overshoot and exhibits fine, high-frequency oscillations (hunting) around the set point.</p>	Overshoot/undershoot and stable time are reduced, however, fine hunting occurs on changes in the curve itself.
When D is decreased	 <p>The graph shows a process value starting from a lower level and rising slowly to a horizontal dashed line labeled 'Set Value'. It reaches the set point with increased overshoot and exhibits larger, lower-frequency oscillations (hunting) around the set point.</p>	Overshoot/undershoot increase, and it takes time for the process value to reach the set point.

3.9 Alarm Output

- Alarm output conditions are determined by the combination of “alarm type”, “alarm value” and “alarm hysteresis”. For detail, see “4.2 Alarm hysteresis”.
- Alarms are supported on the E5GN-□1□□□ (1-alarm model).
- The following describes the “alarm type”, “alarm value”, “upper-limit alarm” and “lower-limit alarm” parameters.

Alarm type

Set Value	Alarm Type	Alarm Output Operation	
		When alarm value X is positive	When alarm value X is negative
0	Alarm function OFF	Output OFF	
*1 1	Upper- and lower-limit (deviation)		*2
2	Upper-limit (deviation)		
3	Lower-limit (deviation)		
*1 4	Upper- and lower-limit range (deviation)		*3
*1 5	Upper- and lower-limit with standby sequence (deviation)		*4
6	Upper-limit with standby sequence (deviation)		
7	Lower-limit with standby sequence (deviation)		
8	Absolute-value upper-limit		
9	Absolute-value lower-limit		
10	Absolute-value upper-limit with standby sequence		
11	Absolute-value lower-limit with standby sequence		

*1 : The upper- and lower-limit values, expressed as “L” and “H”, can be set independently for each alarm point with set values 1, 4 and 5.

*2 : Set value : 1 Upper- and lower-limit alarm

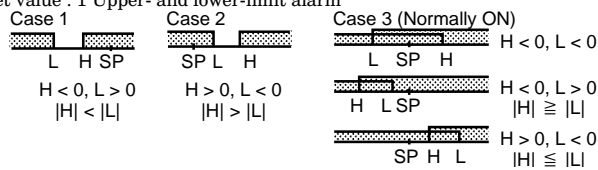

*3 : Set value : 4 Upper- and lower-limit range

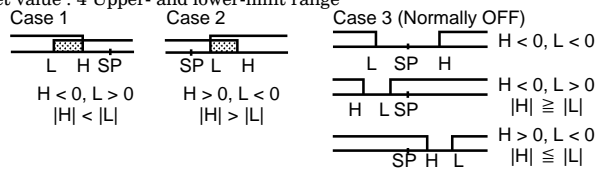

*4 : Set value : 5 Upper- and lower-limit alarm with standby sequence

*For the above upper- and lower-limit alarm

- In cases 1 and 2, the alarm is normally OFF if upper- and lower-limit values of hysteresis overlap.
- In case 3, the alarm is normally OFF.

*5 : Set value : 5 Upper- and lower-limit alarm with standby sequence

The alarm is normally OFF if upper- and lower-limit values of hysteresis overlap.

- Set the alarm type in the “alarm 1 type” parameter (initial setting level). Default is “2: upper-limit alarm (deviation)”.

Alarm value



Lower-limit
alarm value1



Upper-limit
alarm value1

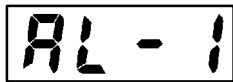

Alarm value1

- Alarm values are indicated by “X” in the table on the previous page. When the upper and lower limits are set independently, “H” is displayed for upper limit values, and “L” is displayed for lower limit values.
- To set the upper- and lower-limit alarm values for deviation, set the upper and lower limits in each of the “Upper limit alarm value 1” and “Lower limit alarm value 1” parameters (operation level).

Operation Procedure

Set “alarm 1” to the upper-limit alarm. The following shows related parameters and setups. In this example, the alarm output is active when the set point is exceeded by “10°C”. (The temperature unit in this example is “°C”.)

“alarm 1 type” = “2”: upper-limit alarm (deviation)
 “alarm value 1” = “10”

Initial setting level

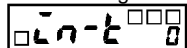

Input type

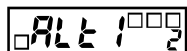

Alarm 1 type

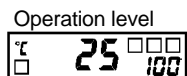

Operation level

PV/SP

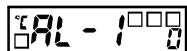

Alarm value 1

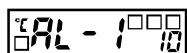

- (1) Press the key for at least three seconds to move from the “operation level” to the “initial setting level”.
- (2) Select the “alarm 1 type” parameter by pressing the key. Check that the “alarm type” parameter is set to “2” (default, upper-limit alarm).
- (3) To return to the “operation level” press the key for at least one second.
- (4) Select “alarm value 1” by pressing .
- (5) Press the key to set the parameter to “10”.

3.10 Requests during Operation

- 1) About two seconds is required for outputs to turn ON when the power is turned ON. Take this into consideration when the temperature controller is incorporated into a sequence circuit.
- 2) Allow at least 30 minutes for warming up.
- 3) When self-tuning is used, turn the temperature controller and load (e.g. heater) ON simultaneously or turn the load ON before the temperature controller. If the load is turned ON before the temperature controller, correct self-tuning and optimum control are no longer possible.

When operation is started after warm-up, turn the power OFF once after warm-up is completed, and then turn the temperature controller and load ON simultaneously. (Instead of turning the temperature controller power ON again, moving from the STOP to the RUN mode also is possible.)

- 4) The temperature controller may be subject to the influence of radio interference if used near a radio, TV or wireless equipment.

CHAPTER 4

APPLIED OPERATION

4.1	Shifting Input Values	4-2
	Shifting input	4-2
	How to calculate input shift values (2-point shift)	4-3
	1-point shift method	4-4
	2-point shift method	4-4
	Example of 2-point temperature input shift	4-5
4.2	Alarm Hysteresis	4-6
	Standby sequence	4-6
	Alarm latch	4-6
	Close in alarm/open in alarm	4-7
4.3	Setting Scaling Upper and Lower Limits (analog input)	4-8
	Analog input	4-8
4.4	Executing Heating and Cooling Control ..	4-9
	Heating and cooling control	4-9
	Setup	4-10
4.5	Setting Multi-SP	4-11
	Setting the SP by key operation	4-11
	Setup	4-11
4.6	Setting the SP Upper and Lower Limit Values	4-13
	Set point limiter	4-13
	Setup	4-14
4.7	Executing the SP Ramp Function (limiting the SP change rate)	4-15
	SP ramp	4-15
4.8	To Move to the Advanced Function Setting Level	4-17
4.9	Using the Key Protect level	4-18
	Key protect	4-18

4.1 Shifting Input Values

Shifting input

1-point shift



- The input shift type matched to the sensor currently selected in the “input type” parameter is displayed.
- 2-point shift is applied only for non-contact temperature sensors.
- With 1-point shift, only the value set to the “Temperature input shift” parameter (adjustment level) is applied to the entire temperature input range. For example, if the input shift value is set to “1.2°C”, the process value is treated as “201.2°C” after input shift is applied when the process value is 200°C.

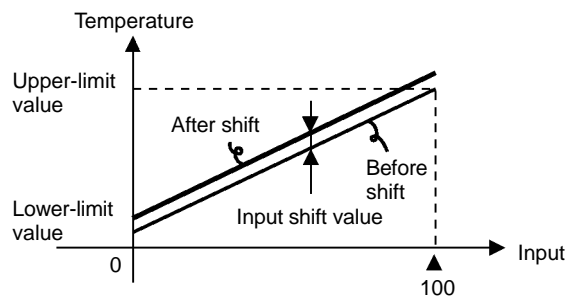

Operation Procedure

Operation level



Adjustment level

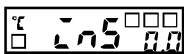
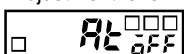

Temperature input shift

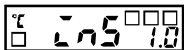

Operation level

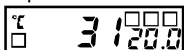

In this example, let's shift the input of the K sensor by “1°C” by 1-point input shift.

Operation level

- (1) Press the key to move from the “operation level” to the “adjustment level”.
- (2) Select the “temperature input shift” parameter by pressing the key.
- (3) Press the or keys to set “1”.
- (4) To return to the “operation level,” press the key. The process value 1°C larger than before shift is applied.

● 2-point shift

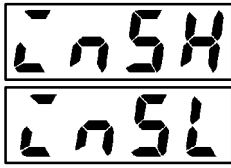

- The input temperature range of non-contact temperature sensors can be shifted by setting an individual value for the upper and lower points of the sensor range. This means that the shift can be applied equally across the range with separate values for each end of the range. For example, if the upper-limit value is set to “2°C” and the lower-limit value is set to “1°C”, the sensor range is shifted by an average of 1.5°C at 50% input.
- Set the upper-limit value in the “upper-limit temperature input shift value” parameter and the lower-limit value in the “lower-limit temperature input shift value” parameter.

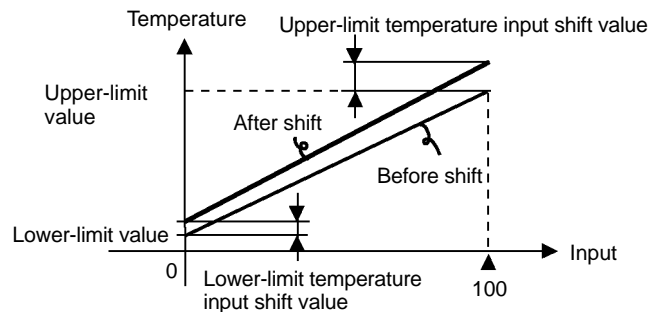

■ How to calculate input shift values (2-point shift)

When the non-contact temperature sensor model ES1A is connected to the E5GN, an offset of several to several tens of a degree can occur. For this reason, offset the readout value by 1-point or 2-point shift as described in this item. This offset occurs as a bias current for detecting controller sensor error flows to the output impedance of the non-contact temperature sensor. 2-point shift can be carried out only on non-contact temperature sensors, and cannot be set for other input types.

[Preparations]

- (1) Set to the temperature range matching the input specifications of the non-contact temperature sensor. (ES1A is supported only in thermocouple input types on the E5GN.)
- (2) Prepare a thermometer capable of measuring the temperature of the control target as shown in Figure 1 so that 1-point shift or 2-point shift can be carried out.

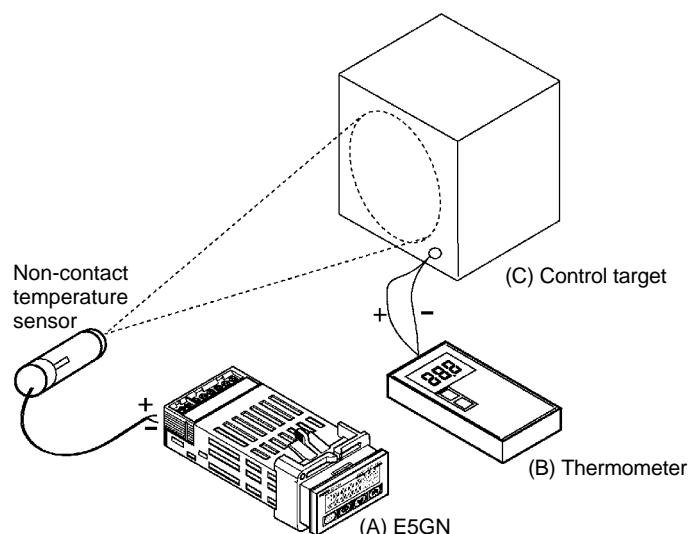
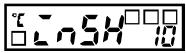

Figure 1 Configuration When Compensating a Non-contact Temperature Sensor

1-point shift method

Adjustment level



Upper-limit temperature input shift value

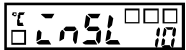

Lower-limit temperature input shift value

- (1) In the configuration shown in Figure 1, bring the set point to near the value at which the temperature of the control target is to be controlled. Let's assume that the control target temperature (C) and the control target temperature (B) are matching.
- (2) Check the control target temperature (B) and the controller readout (A). Take the following value as the input shift value, and set the same numerical values to "12.54" and "12.52".

$$\text{control target temperature (B) - controller readout (A)}$$

Figure 2 shows the effect of 1-point temperature input shift.

- (3) After you have set the input shift values, check controller readout (A) and control target temperature (B). If they are almost the same, this completes temperature input shift.

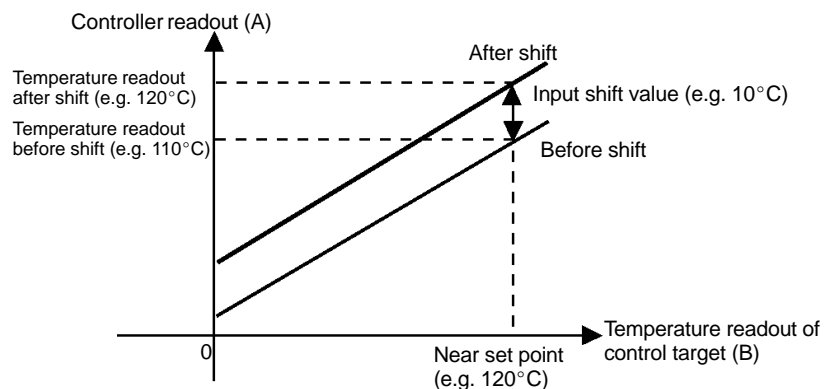

Figure2 1-point Temperature Input Shift

2-point shift method

Use 2-point input shift if you want to increase the accuracy of the readout values across the range of the sensor.

- (1) Shift the controller readout by two points, near room temperature and near the value at which the temperature of the control target is to be controlled. For this reason, bring the control target temperature to near room temperature and to near the set point, and check control target temperature (B) and controller readout (A).
- (2) Using equations (1) and (2) calculate the upper- and lower-limit temperature input shift values from the readout and temperature to be shifted that you obtained in step 1.

Figure 3 shows the effect of shift by 2-point temperature input shift.

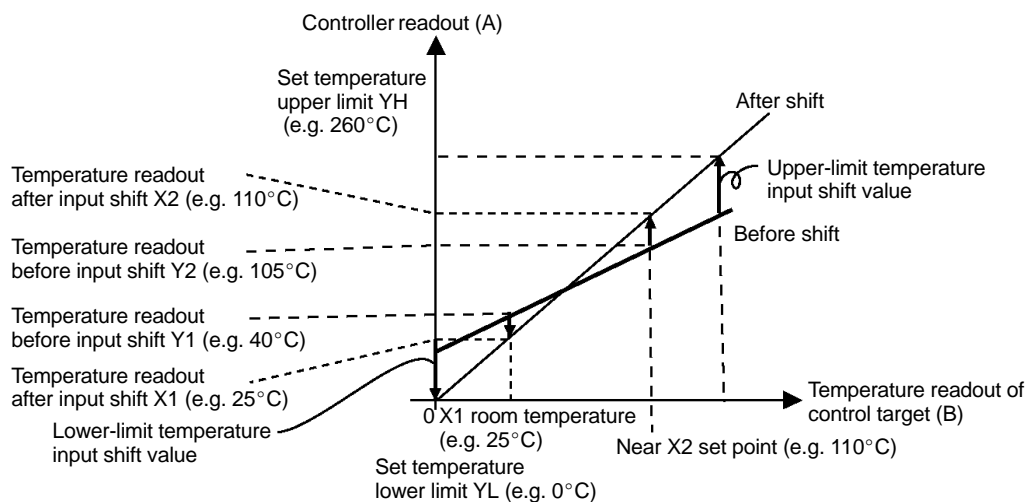

Figure3 2-point Temperature Input Shift

- Use the following equation to calculate the lower-limit temperature input shift value.

$$\Delta T_{L} = \frac{Y_L - Y_1}{Y_2 - Y_1} \times \{(X_2 - Y_2) - (X_1 - Y_1)\} + (X_1 - Y_1) \dots \text{equation 1}$$

- Use the following equation to calculate the upper-limit temperature input shift value.

$$\Delta T_{H} = \frac{Y_H - Y_1}{Y_2 - Y_1} \times \{(X_2 - Y_2) - (X_1 - Y_1)\} + (X_1 - Y_1) \dots \text{equation 2}$$

- (3) After you have set the calculated values to “ ΔT_L ” and “ ΔT_H ”, check controller readout (A) and control target temperature (B).
- (4) Although the input shift was carried out at two points, close to room temperature (ambient temperature), and near to the set point, select points close to each end of the sensor range to improve accuracy across the full range of the sensor measurement range.

NOTE Before selecting these values, check that they will not damage the controller if applied.

■ Example of 2-point temperature input shift

In this example, we use the ES1A K 0 to 260°C specification.

YL and YH in equations 1 and 2 are set temperature lower limit YL is 0°C and set temperature upper limit YH is 260°C. Check the temperature of the control target.

When the room temperature X1 is 25°C, the readout on the controller Y1 is 40°C, and when the temperature near the set point X2 is 110°C, the readout on the controller Y2 becomes 105°C.

Adjustment level

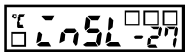

Lower-limit temperature input shift value

Lower-limit temperature input shift value

$$\Delta T_L = \frac{0 - 40}{105 - 40} \times \{(110 - 105) - (25 - 40)\} + (25 - 40) = -27.3(^{\circ}\text{C})$$

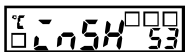

Upper-limit temperature input shift value

Upper-limit temperature input shift value

$$\Delta T_H = \frac{260 - 40}{105 - 40} \times \{(110 - 105) - (25 - 40)\} + (25 - 40) = 52.7(^{\circ}\text{C})$$

4.2 Alarm Hysteresis

- The hysteresis of alarm outputs when alarms are switched ON/OFF can be set as follows:



- Alarm hysteresis is set independently for each alarm in the “alarm hysteresis 1” parameters (advanced function setting level). Default is “0.2EU”.

■ Standby sequence

- “Standby sequence” is a function which allows the alarm outputs to be temporarily disabled while the first alarm condition occurs. From here on, the alarm output is active for future alarm conditions.
- For example, in a standard heating application, if you used the standard “low alarm”, the alarm would be active from switching the controller ON. However, with “Standby Sequence”, the alarm output is disabled during the first warmup, and the temperature has to rise above the alarm set point before the alarm can become active. Then, if the temperature falls below the alarm set point, the output is active.

● Restart

- The standby sequence is canceled when an alarm is output. It is, however, restarted later by the “standby sequence” parameter (advanced function setting level). For details, see the “standby sequence” parameter in “Chapter 5, Parameters.”

■ Alarm latch

- “Alarm latch” is a function where alarm output once turned ON stays ON regardless of the temperature.
- The alarm latch can be canceled by turning the power OFF. (Note, however, that it can also be canceled by switching to the initial setting level, communications setting level, advanced function setting level or calibration level.

Close in alarm/ open in alarm

- When the E5GN is set to “close in alarm,” the status of the alarm output is normally open. When set to “open in alarm,” the status of the alarm output is output inverted, or normally closed.
- Alarm type and close in alarm (normally open)/open in alarm (normally closed) can be set independently for each alarm.
- Close in alarm/open in alarm is set in the “alarm 1 open in alarm” parameters (advanced function setting level). Default is “ $\alpha-5$: close in alarm”.
- When “alarm 1 open in alarm” (advanced function setting level) is set to “open in alarm”, the heater burnout alarm and input error output also become “open in alarm”.

	Alarm Output Function	Output	Alarm LCD
Close in alarm	ON	ON	Lit
	OFF	OFF	Out
Open in alarm	ON	OFF	Lit
	OFF	ON	Out

Alarm output turns OFF (relay contact open) at a power interruption and for about two seconds after the power is turned ON regardless of the close in alarm/open in alarm setting.

Summary of alarm operations

The figure below visually summarizes the above description of alarm operations (when alarm type is set to “lower-limit alarm with standby sequence” and E5GN is set to “close in alarm”).

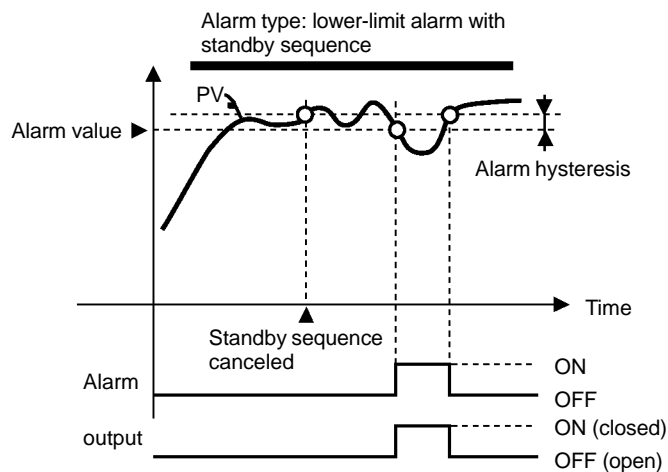

Parameters

Symbol	Parameter : Level	Description
$\alpha H 1$	Alarm 1 hysteresis: Advanced function setting level	Alarm
$\alpha E S t$	Standby sequence reset method: Advanced function setting level	Alarm
$\alpha L 1 \alpha$	Alarm 1 open in alarm: Advanced function setting level	Alarm

4.3 Setting Scaling Upper and Lower Limits (analog input)

Analog input

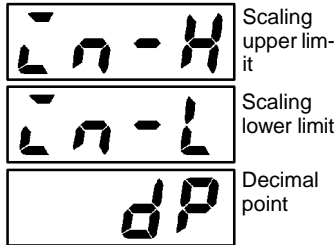

- When an analog input (voltage input) is selected, scaling matched to the control is possible.
- Scaling is set in the “scaling upper limit”, “scaling lower limit” and “decimal point” parameters (initial setting level). These parameters cannot be used when temperature input type is selected.
- The “scaling upper limit” parameter sets the physical quantity to be expressed by the upper limit value of input, and the “scaling lower limit” parameter sets the physical quantity to be expressed by the lower-limit value of input. The “decimal point” parameter specifies the number of digits past the decimal point.
- The following figure shows a scaling example of 0 to 5 mV input. After scaling, the humidity can be directly read.

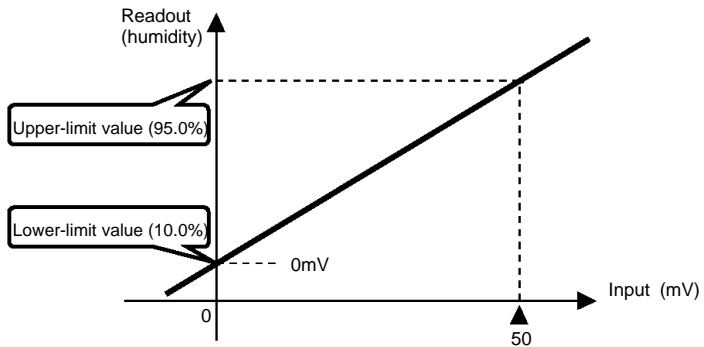

Operation Procedure

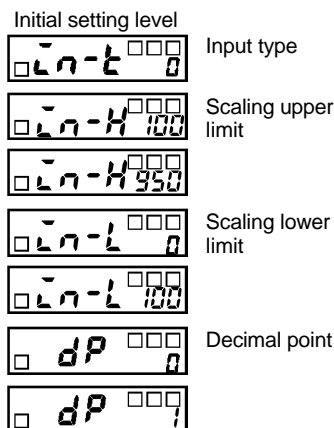

In this example, let's set the scaling upper- and lower-limits so that inputs 0 to 50 mV are 10.0% to 95.0%.

- (1) Press the key for at least three seconds to move from the “operation level” to the “initial setting level”.
- (2) Select “scaling upper limit” by pressing .
- (3) Press the or key to set the parameter to “950”.
- (4) Select “scaling lower limit” by pressing .
- (5) Press the or key to set the parameter to “100”.
- (6) Select the decimal point position by pressing .
- (7) Press the or key to set the parameter to “1”.
- (8) To return to the “operation level” press the key for at least one second.

4.4 Executing Heating and Cooling Control

■ Heating and cooling control

Heating and cooling control can be used on E5AN-□3□□□ controllers. Heating and cooling control operates when “H-□ : heating and cooling” is selected in the “standard/heating and cooling” parameter. Select the standard heating control or cooling control according to the following table:

Setting		Output	
Control Method	Direct/reverse operation	Control output 1	Control output 2
standard control	Reverse operation	Control output (heat)	-
standard control	Direct operation	Control output (cool)	-
Heating and cooling control	Reverse operation	Control output (heat)	Control output (cool)
Heating and cooling control	Direct operation	Control output (cool)	Control output (heat)

(The parameter default is heating control (standard).)

- When heating and cooling control is selected, the “dead band” and “cooling coefficient” parameters can be used.

● Dead band

The dead band is set with the set point as its center on the E5GN-□1□□. The dead band width is the set value of the “dead band” parameter (adjustment level). Setting a negative value produces an overlap band. Default is “0.0 EU.”

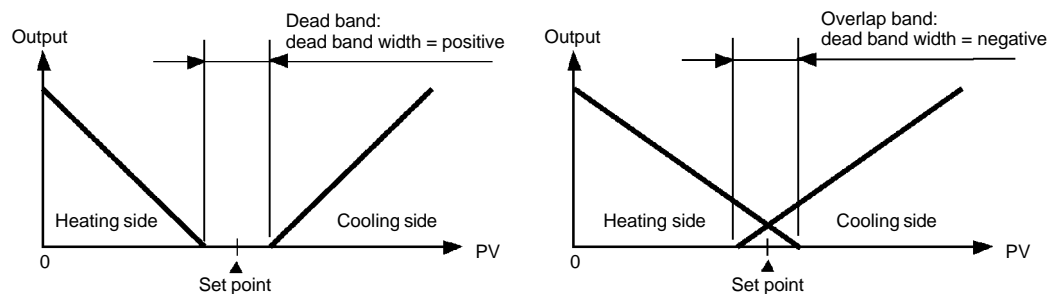

● Cooling coefficient

If the heating and cooling characteristics of the control target greatly differ, preventing satisfactory control characteristics from being obtained by the same PID constants, adjust the proportional band (P) at the cooling side using the cooling coefficient to balance control between the heating and cooling sides. In heating and cooling control, P at the heating or cooling side is calculated by the following formula:

Heating side $P = P$

Cooling side $P = P \times \text{cooling coefficient}$

The cooling coefficient is applied to control output 1 side P to obtain control whose characteristics (control output 2 side P) differ from those on the control output 1 side.

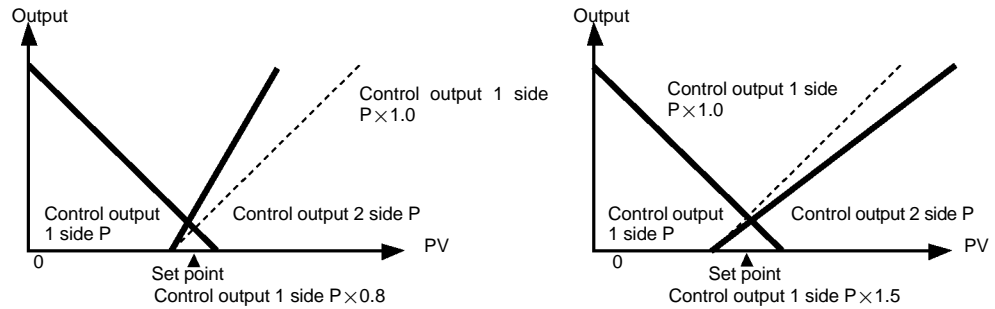

■ Setup

To set heating and cooling control, set the “standard/heating and cooling”, “dead band” and “cooling coefficient” parameters.

- Setting heating and cooling control

Operation Procedure

“standard/heating and cooling” = “heating and cooling”

Initial setting level

□ 5-HC □□□□

Standard/heating and cooling

- (1) Press the key for at least three seconds to move from the “operation level” to the “initial setting level”.
- (2) Select “standard heating and cooling control” in the “initial setting level”.

5end: Standard control

H-C : Heating and cooling control

- Setting dead band

Operation Procedure

“Dead band” = “5”

Adjustment level

□ 5-db □□□□

Dead band

- (1) Select “dead band” in the “adjustment level”.
- (2) Use the keys to set the parameter to “5.0”.
The setting range is -199.9 to 999.9.

□ 5-db □□□□

- Setting cooling coefficient

Operation Procedure

Cooling coefficient = 10

Adjustment level

□ C-SC □□□□

Cooling coefficient

- (1) Select “cooling coefficient” in the “adjustment level”.
In this example, set the parameter to “10”.

- (2) Use the keys to set the parameter to “10.00”.
The setting range is 0.01 to 99.99.

□ C-SC □□□□

4.5 Setting Multi-SP

■ Setting the SP by key operation

You can select set points 0 to 3 by changing the set value of the “multi-SP” parameter. The “multi-SP” display conditions are as follows:

The following table shows the relationship between the “multi-SP” parameter set value and the selected set point.

Multi-SP	Selected Set Point
0	Set point 0
1	Set point 1
2	Set point 2
3	Set point 3

■ Setup

Before you set the “Multi-SP”, cancel protection and move to the “advanced function setting level”.

Set “Multi-SP uses” to ON in the advanced function setting level.

Operation Procedure

protect level



Operation /adjustment protection



Initial setting/communications protection



Initial setup/communications protection

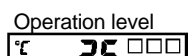

PV/SP

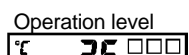
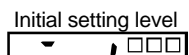
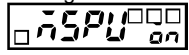
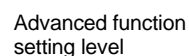
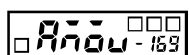
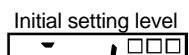

In the following example, let's set the set point to “2”.

- (1) Press the key and key simultaneously for at least three seconds to move from the “operation level” to the “protect level”.
 - * The key pressing time can be changed in “protect level move time” (advanced function level).
- (2) Select “initial setting/communications protection” by pressing the key.
- (3) Set the parameter to “0” (move to advanced function setting level enabled).
- (4) Press the key and key simultaneously for at least one second to move from the “protect level” to the “operation level”.
- (5) Press the key for at least three seconds to move to the “initial setting level”.
- (6) Select “move to advanced function setting level” by pressing the key.
- (7) Press the key to enter the “-169” (password).
- (8) Select “Multi-SP uses” by pressing the key. Set the parameter to ON.
- (9) Press the key for at least one second to move to the “initial setting level”.
- (10) Press the key for at least one second to move to the “operation level”.

Multi-SP

(11) Select “Multi-SP” by pressing the key.

Multi-SP

(12) Press the key to set the parameter to “2” (set point “2”).

Parameters

Symbol	Parameter Name: Level	Description
\bar{n} -SP	Multi-SP : Operation level	For setting the set points
SP-0	Set point 0 : Adjustment level	Set point 0 to 3
SP-1	Set point 1 : Adjustment level	
SP-2	Set point 2 : Adjustment level	
SP-3	Set point 3 : Adjustment level	

4.6 Setting the SP Upper and Lower Limit Values

■ Set point limiter

The setting range of the set point is limited by the set point limiter. The set point limiter is used to prevent the control target from reaching abnormal temperatures. The upper- and lower-limit values of this set point limiter are set by the “set point upper limit” and “set point lower limit” parameters in the “initial setting level”, respectively. However, note that when the set point limiter is reset, the set point is forcibly changed to the upper- or lower-limit value of the set point limiter if the set point is out of the limiter range. Also, when the input type and temperature unit are changed, the set point limiter is forcibly reset to the sensor setting range.

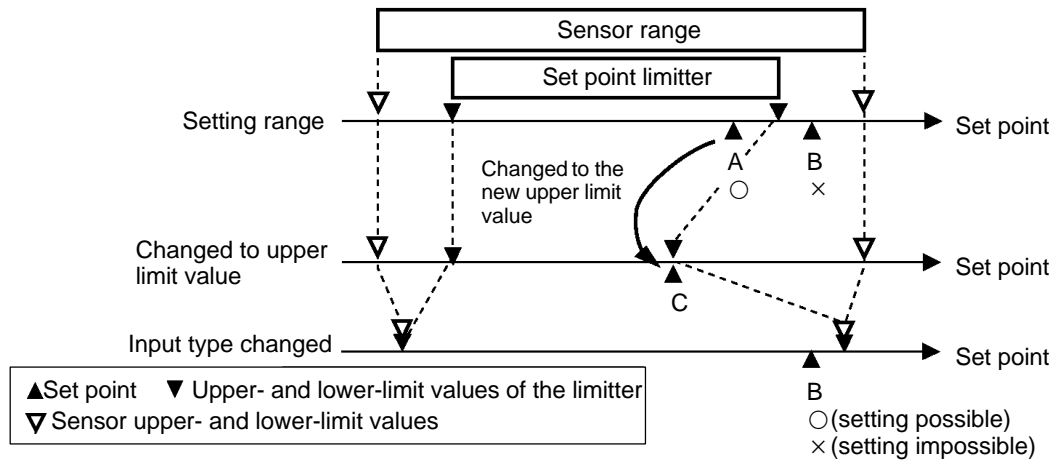

Parameters

Symbol	Parameters : Level	Description
SL-H	Set point upper limit : Initial setting level	For limiting SP setting
SL-L	Set point lower limit : Initial setting level	For limiting SP setting

■ Setup

To set the set point upper and lower limits, set in the “set point upper limit” and “set point lower limit” parameters in the “initial setting level”. This example describes how to set the set point limiter “-200 to 1300°C” to input type K thermocouple.

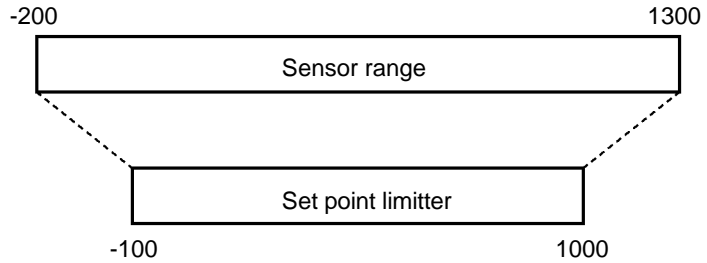

• Setting the set point upper limit

Operation Procedure

Initial setting level
 Input type

Set point upper limit

Set the “set point upper limit” parameter to “1000”.

- (1) Press the key for at least three seconds to move from the “operation level” to the “initial setting level”.
- (2) Select “set point upper limit”.
- (3) Press the or key to set the parameter to “1000”.

• Setting the set point lower limit

Operation Procedure

Set point lower limit

Set the “set point lower limit” parameter to “-100”.

- (1) Select “set point lower limit” in the “initial setting level”.
- (2) Press the or key to set the parameter to “-100”.

4.7 Executing the SP Ramp Function (limiting the SP change rate)

■ SP ramp

With the SP ramp function, the controller operates according to the value (set point during SP ramp) limited by a change rate. The interval in which the set point during SP ramp is limited is referred to as the “SP ramp”.

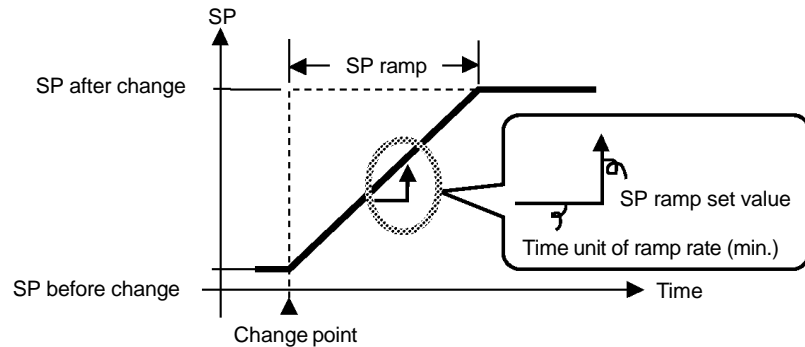

The change rate during SP ramp is specified by the “SP ramp set value” parameter. The “SP ramp set value” default is “OFF”, and the SP ramp function is disabled.

Changing of the ramp set point can be monitored in the “set point during SP ramp” parameter (operation level). Use this parameter during mounting of the SP ramp.

Parameters

Symbol	Parameters : Level	Description
$\bar{O}L-H$	MV upper limit : Advanced function setting level	For limiting manipulated variable
$\bar{O}L-L$	MV lower limit : Advanced function setting level	For limiting manipulated variable
$SL-H$	Set point upper limit: Initial setting level	For limiting SP setting
$SL-L$	Set point lower limit: Initial setting level	For limiting SP setting
$SPrt$	SP ramp set value: Advanced function setting level	For limiting SP change rate

- **Operation at start** If the SP ramp function is enabled when the E5GN is turned ON, and when “run” is switched to from “stop,” the process value may reach the set point after SP ramp in the same way as when the set point is changed. In this case, operation is carried out with the process value regarded as the set point before the change was made.

The direction of the SP ramp changes according to the relationship between the process value and the set point.

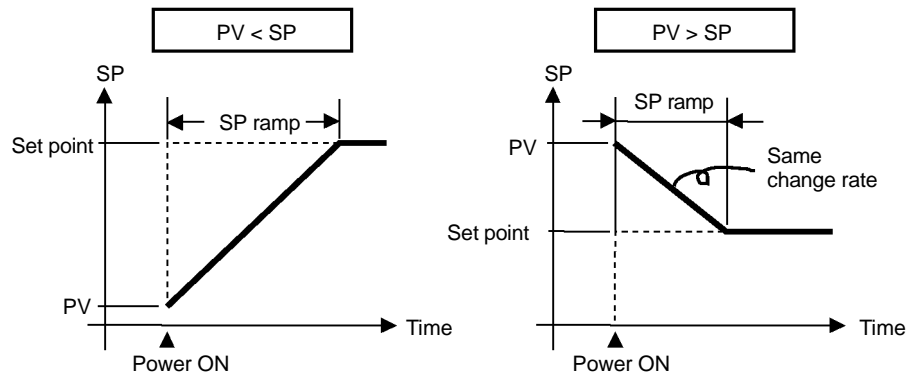



- **Restrictions during SP ramp operation**

- Execution of auto-tuning starts after the end of SP ramp.
- When control is stopped or an error occurs, the SP ramp function is disabled.

4.8 To Move to the Advanced Function Setting Level

To move to the advanced function setting level, you must cancel “initial setting/communications protection” in the protect level.

In the default setting, you cannot move to the advanced function setting level.

- (1) Press the  and  keys simultaneously for at least three seconds in the “operation level.”

* The key pressing time can be changed in “protect level move time” (advanced function level).

Protect level



“operation/adjustment protection”

- (2) The controller moves to the protect level, and “operation/adjustment protection” is displayed.

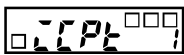

“initial setting/communications protection”

- (3) Press the  key once to move to “initial setting/communications protection.”

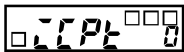



- (4) Set the set value to “0”

Operation level



PV/SP

- (5) Press the  and  keys simultaneously to return to the “operation level.”

Initial setting level

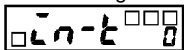

Input type

- (6) Press the  key for at least three seconds to move to the “initial setting level” from the “operation level.”





Move to advanced function setting level

- (7) Select the “Move to advanced function setting level” parameter by pressing the  key.

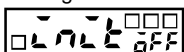

Advanced function setting level



- (8) Press the  key to enter the password (“-169”), and either press the  key or leave the setting for at least two seconds to move to the “advanced function setting level” from the “initial setting level.”

4.9 Using the Key Protect level

■ Key protect

- To move to the protect level, press the  and  keys simultaneously for at least three seconds.
 - * The key pressing time can be changed in "protect level move time" (advanced function level).
- The protect level protects parameters that are not changed during controller operation until operation is started to prevent them from being modified unintentionally. Three levels of protection are provided on the E5GN, "operation/adjustment protection", "initial setting/communications protection" and "setting change protection".
- The protect level setting restricts the range of parameters that can be used.

● Operation/adjustment protection

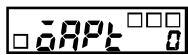

The following table shows the relationship between set values and the range of protection.

Level		Set value			
		0	1	2	3
Operation level	PV	○	○	○	○
	PV/SP	◎	◎	◎	○
	Other	◎	◎	×	×
Adjustment level		◎	×	×	×

- ◎ : Can be displayed and changed
- : Can be displayed
- × : Cannot be displayed and move to other levels not possible

- When this parameter is set to "0", parameters are not protected.
- Default is "0".

● Initial setting/communications protection

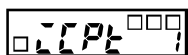

This protect level restricts movement to the initial setting level, communication setting level and advanced function setting level.

Set value	Move to initial setting level	Move to communications setting level
0	Possible ("move to advanced function setting level enabled" parameter displayed)	Possible
1	Possible ("move to advanced function setting level enabled" parameter not displayed)	Possible
2	Not possible	Not possible

- Default is "1".

● Setting change protection

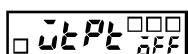

This protect level protects setup from being changed by operating the keys on the front panel.

Set value	Description
OFF	Setup can be changed by key operation.
ON	Setup cannot be changed by key operation. (The protect level can be changed.)

- Default is "OFF".

CHAPTER 5

PARAMETERS

Conventions Used in this Chapter	5-2
Protect Level	5-3
Operation Level	5-4
Adjustment Level	5-10
Initial Setting Level	5-17
Advanced Function Setting Level	5-25
Communications Setting Level	5-36

Conventions Used in this Chapter

■ Meanings of icons used in this chapter



Function

Describes the functions of the parameter.



Setting

Describes the setting range and defaults of the parameter setting.



Monitor

Describes the monitor range.



Example of use

Describes the parameter operations.



See

Describes related parameters and items.

■ About parameter display

Parameters are displayed only when the “Conditions of Use” on the right of the parameter heading are satisfied. However, note that the settings of protected parameters are still valid, and are not displayed regardless of the conditions of use.

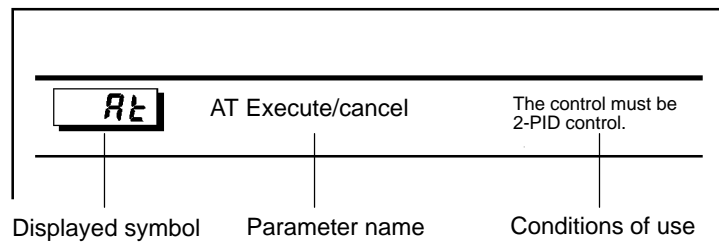

■ About the Order in Which Parameters Are Described in This Chapter

Parameters are described level by level.

The first page of each level lists the parameters available in that level. The parameter names in this list are listed in the order that they are displayed on the E5GN.

Protect Level

Three levels of protection are provided on the E5GN, “operation/adjustment protection”, “initial setting/communications protection” and “setting change protection.” These protect levels prevent unwanted operation of the keys on the front panel in varying degrees.

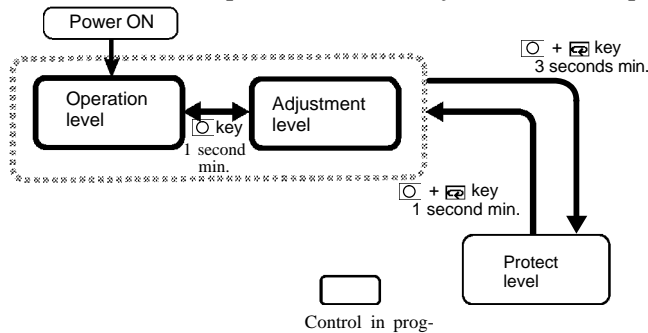

To move from the operation level to the protect level, press the **O** and **F** keys for at least three seconds.

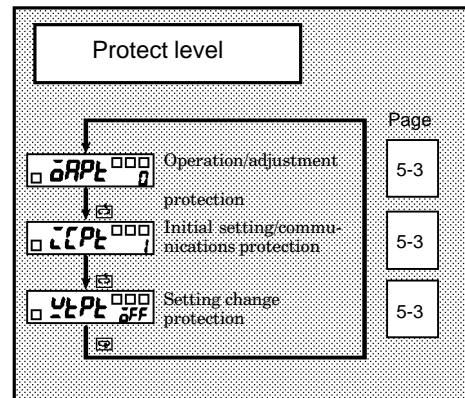

The settings of protected parameters are not displayed and so cannot be modified.



Operation/adjustment protection



Initial setting/communications protection



Setting change protection

This parameter specifies the range of parameters to be protected. indicates the default.



Function



Setting

● Operation/adjustment protection

The following table shows the relationship between set values and the range of protection.

Level		Set value			
		0	1	2	3
Operation level	PV	○	○	○	○
	PV/SP	⊙	⊙	⊙	○
	Other	⊙	⊙	×	×
Adjustment level		⊙	×	×	×

⊙ : Can be displayed and changed

○ : Can be displayed

× : Cannot be displayed and move to other levels not possible

- Parameter items are not protected when the set value is set to “0”.

● Initial setting/communications protection

This protect level restricts movement to the initial setting level and communication setting level.

Set value	Move to initial setting level	Move to communications setting level
0	Possible (“move to advanced function setting level enabled” parameter displayed)	Possible
1	Possible (“move to advanced function setting level enabled” parameter not displayed)	Possible
2	Not possible	Not possible

● Setting change protection

Changes to setups by key operation are restricted.

Set value	Description
OFF	Setup can be changed by key operation.
ON	Setup cannot be changed by key operation. (The protect level can be changed.)

Operation Level

Display this level when you are to carry out control operations on the E5GN. You can set alarm values or monitor the manipulated variable in this level.

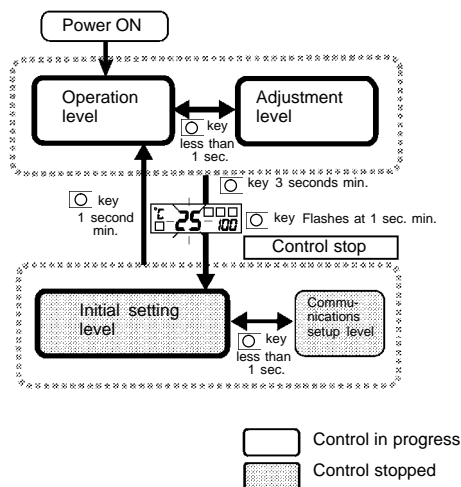

This level is automatically displayed immediately after the E5GN is turned ON. To move to other levels, press the key or the and keys.

- You can change process value/set point by setting operation/adjustment protection to 0, 1, or 2. Process value/set point is displayed by setting value 3 only.
- Protect setting is set in “operation/adjustment protection level”.

Operation level		Page
25	PV	5-5
25 100	PV/SP	5-5
n-SP	Multi-SP	5-5
SP-n	Set point during SP ramp	5-6
r-S	Run/stop	5-7
AL-1	Alarm value 1	5-7
AL H	Upper-limit alarm value 1	5-8
AL L	Lower-limit alarm value 1	5-8
-o	MV monitor (OUT1)	5-8
[-o	MV monitor (OUT2)	5-9

Operation Level

PV

The “additional PV display” parameter must be set to “ON”.



Function

The process value is displayed on the No.1 display, and nothing is displayed (blank) on the No.2 display.



Monitor

	Monitor Range	Unit
Process Value	Input indication range (See page A-10).	EU

The decimal point position is dependent on the selected sensor.



See

● Related parameters

“Input type” (initial setting level) (p. 5-18)

“Set point upper limit” “Set point lower limit” (initial setting level) (p. 5-20)

PV/SP



Function

The process value is displayed on the No.1 display, and the set point is displayed on the No.2 display.

	Monitor Range	Unit
Process Value	Input indication range (See page A-10).	EU
Set Point	Set point lower limit to set point upper limit	EU



See

Refer to the PV parameter.



Multi-SP (set point 0 to 3)

The “multi-SP uses” parameter must be set to “ON”.



Function

Multi-SP allows you to set up to four set points (SP 0 to 3) in adjustment level. These can be switched by operating the keys on the front panel. In the parameter, enter set points 0 to 3.



See

- Multi-SP can also be selected by communications.

Operation Level

SP-r

Set point during SP ramp

The “SP ramp set value” parameter must not be set to “OFF”.

This parameter monitors the set point during SP ramp.



Function

“Ramp” is a function for restricting the change width of the set point as a change rate. The set value is displayed when “SP ramp set value” parameter (advanced function setting level) is set.

When the set point is out of the preset ramp, the set point is matched to the set point set in the “PV/SP” parameter.



Monitor

Monitor Range	Unit
SP: Set point lower limit to set point upper limit	EU



See

● Related parameters

“PV/SP” (operation level) (p. 5-5)

“SP ramp set value” (advanced function setting level) (p. 5–27)

“Set point upper limit” “Set point lower limit” (initial setting level) (p. 5-20)

r - 5 Run/Stop

This parameter specifies run and stop.



Function

When “*rUn*: run” is selected, control is running. When “*StōP*: stop” is selected, control is stopped. When control is stopped, the *StōP* display lights. Default is “*rUn*”.

AL - 1 Alarm value 1

The control must be set to standard control. The alarm type must be set to other than upper and lower limit alarm.

This parameter sets the input value “X” in the alarm type list.



Function

- This parameter is used for setting the alarm values of alarm outputs.
- During temperature input, the decimal point position is dependent on the currently selected sensor, and during analog input it is dependent on the “decimal point” parameter setting.



Setting

Setting Range	Unit	Default
-1999 to 9999	EU	0



See

This parameter can be set alarm function OFF or other than upper and lower limit alarm.

● Related parameters

“Input type” “Scaling upper limit” “Scaling lower limit” “Decimal point”

“Alarm 1 type” (initial setting level) (p. 5-18, 19)

“Alarm 1 open in alarm” “Alarm 1 hysteresis” (p. 5-29) “Standby sequence reset method” (p. 5-28) “Alarm latch” (p. 5-34) (advanced function setting level)

Operation Level

AL 1H

Upper-limit alarm value 1

AL 1L

Lower-limit alarm value 1

The control must be set to standard control. Alarm 1 type must be set to upper and lower limits, upper and lower limit range, or upper- and lower-limit alarm with standby sequence.

This parameter independently sets the upper- and lower-limit alarm values when the mode for setting the upper and lower limits is selected for alarm 1 type (initial setting level).



Function

- This parameter sets the upper and lower limit values of alarm 1.
- During temperature input, the decimal point position is dependent on the currently selected sensor, and during analog input it is dependent on the “decimal point” parameter setting.



Setting

Setting Range	Unit	Default
-1999 to 9999	EU	0



See

- Related parameters
 - “Alarm 1 type” (initial setting level) (p. 5-23)
 - “Standby sequence reset method” (p. 5-28)
 - “Alarm 1 open in alarm”
 - “Alarm 1 hysteresis” (p. 5-29)
 - “Alarm 1 latch” (p. 5-34) (advanced function setting level)

0

MV monitor (OUT1)

Manipulated variable display must be set to “ON”.

This parameter is for monitoring the manipulated variable during operation.



Function

- This parameter cannot be set.
- During standard control, the manipulated variable is monitored, and during heating and cooling control, the manipulated variable on the control output 1 side is monitored.
- Default is “OFF” and the manipulated variable is not displayed.



Monitor

Control	Monitor Range	Unit
Standard	0.0 to 100.0	%
Heating and cooling	0.0 to 100.0	%



See

- Related parameter
 - “Manipulated variable display” (advanced setting level) (p. 5-33)

MV monitor (OUT2)

The control must be heating and cooling control.
Manipulated variable display must be set to "ON".

This parameter is for monitoring the manipulated variable on the control output 2 side during operation.



Function

- During heating and cooling control, the manipulated variable on the control output 2 side ("OUT 2" terminal output) is monitored.

Control	Monitor Range	Unit
Heating and cooling	0.0 to 100.0	%



See

- Related parameters
 - “Standard/heating and cooling” (initial setting level) (p. 5-19)
 - “Manipulated variable display” (advanced function setting level) (p. 5-29)

Adjustment Level

This level is for executing AT (auto-tuning) or setting up the control.



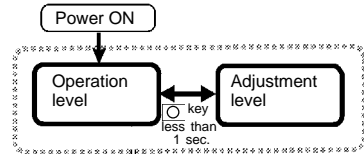







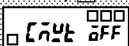

This level provides you with basic controller setup parameters for PID (proportional band, integral time, derivative time).

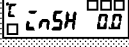
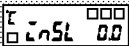

 Control in progress

To move to the adjustment level from the operation level, press the  key for less than one second.

- The set points 0 to 3 in the adjustment level are set values for switching the set point during multi-SP input.
- You can change adjustment level parameters by setting operation/adjustment protection to “0”. If the protect level is set “1” to “3”, adjustment level parameters cannot be displayed and the adjustment level cannot be moved to.

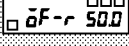
Adjustment level		Page
 AT execute/cancel		5-11
 Communications writing		5-11
 Set point 0		5-12
 Set point 1		5-12
 Set point 2		5-12
 Set point 3		5-12
 Temperature input shift value		5-13
 Upper-limit temperature input shift value		5-13
 Lower-limit temperature input shift value		5-13
 Proportional band		5-14
 Integral time		5-14
 Derivative time		5-14
 Cooling coefficient		5-15
 Dead band		5-15
 Manual reset value		5-16
 Hysteresis (OUT1)		5-16
 Hysteresis (OUT2)		5-16

AT

AT execute/cancel

The E5GN must be in operation, and control must be 2-PID control.

This parameter executes AT (auto-tuning).





Function

- When you execute auto-tuning, the optimum PID parameters “proportional band,” “integral time” and “derivative time” for the set point during program execution are automatically set by forcibly changing the manipulated variable to calculate the characteristics of the control target.



Example of use

- Normally, this parameter is set to “OFF”. If you press the  or  keys, the parameter is turned ON and AT is executed. AT cannot be executed when control has stopped or during ON/OFF control.
- When AT execution ends, the parameter setting automatically returns to “OFF”.



See

- Related parameters
 “Proportional band” “Integral time” “Derivative time” (adjustment level) (p. 5-14)
 “PID / ON/OFF” (initial setting level) (p. 5-21)

CA2E

Communications writing

Model E5GN-□03□ must be used.



Function

This parameter enables/disables writing of parameters to the E5GN from the host (personal computer) by communications.



Setting

ON : Writing enabled
 OFF : Writing disabled
 Default : OFF



See

- Related parameters
 “MB command logic switching” (advanced function level) (p.5-36)
 “Communication unit No.” “Baud rate” “Data bit” “Parity” “Stop bit” (communications setting level) (p. 5-37)

Adjustment Level

SP-0

Set point 0

The "Multi-SP uses" parameter must be set to "ON".

SP-1

Set point 1

SP-2

Set point 2

SP-3

Set point 3

These parameters set the set points when the multi-SP function is used.



Function

The values set in these parameters can be selected by operating the keys on the front panel.

- When the set point has been changed, the set value of these parameters currently set by multi-SP is linked and changed.
- During temperature input, the decimal point position is dependent on the selected sensor.

During analog input, the decimal point position is dependent on the setting of the "decimal point position" parameter.



Setting

Setting Range	Unit	Default
Set point lower limit to set point upper limit	EU	0



See

● Related parameters

"PV/SP" (operation level) (p. 5-5)

"Input type" (initial setting level) (p. 5-18)

"Multi-SP uses" (advanced function setting level) (p. 5-26)

Ln5

Temperature input shift

The “input type” parameter must be set to temperature input excluding a non-contact temperature sensor.

Sometimes an error between the set point and the actual temperature occurs. To offset this, a value obtained by adding an input shift value to the input is displayed as the measurement value and used for control.



Function

The entire input range is shifted by a fixed rate (1-point shift). If the input shift value is set to “-1°C”, the set point is controlled to a value obtained by subtracting 1°C from the actual temperature.



Setting

Setting Range	Unit	Default
-199.9 to 999.9	°C or °F	0.0



See

- Related parameter
“Input type” (initial setting level)

Ln5H

Upper-limit temperature input shift value

The “input type” parameter must be set to only the non-contact temperature sensor.

Ln5L

Lower-limit temperature input shift value

Whereas the entire input range is shifted by a fixed rate (1-point shift) in the “temperature input shift” parameter, the input range is shifted by two points (2-point shift) at the upper and lower limits. 2-point shift enables more accurate offset of the input range compared with 1-point shift, if the input shift values at the upper and lower limits differ.



Function

This parameter sets input shift values for each of the upper and lower limits (2-point shift) of the input range.



Setting

Setting Range	Unit	Default
-199.9 to 999.9	°C or °F	0.0



See

- Related parameter
“Input type” (initial setting level)

Adjustment Level



Proportional band

The control must be 2-PID control.



Integral time



Derivative time

This parameter sets the PID parameters. Note that PID is automatically set when AT and ST are executed.



Function

Proportional action : P refers to control in which the MV is proportional to the deviation (control error).

Integral action : I gives a control action that is proportional to the time integral of the control error. With proportional control, there is normally an offset (control error). So, proportional action is used in combination with integral action. As time passes, this control error disappears, and the set point comes to agree with the control temperature (process value).

Derivative action : D gives a control action that is proportional to the time derivative of the control error. As proportional control and integral control correct for errors in the control result, the control system will be late in responding to sudden changes in temperature. Derivative action enables control that is proportional to a predicted process output to correct for future error.



Setting

Parameter	Setting Range	Unit	Default
Proportional band	0.1 to 999.9	EU	8.0
Integral time	0 to 3999	Second	233
Derivative time	0 to 3999	Second	40



See

- Related parameter
“AT execute/cancel” (adjustment level) (p. 5-11)

Adjustment Level

C-5C

Cooling coefficient

The control must be either heating and cooling control and 2-PID control.

If the heating and cooling characteristics of the control target greatly differ, preventing satisfactory control characteristics from being obtained by the same PID parameters, adjust the proportional band (P) at the control output 2 side by adding the cooling coefficient to balance control between the control output 1 and control output 2 sides.



Function

In heating and cooling control, control output 2 side P is calculated by the following formula to set the cooling coefficient:

$$\text{Control output 2 side P} = \text{Cooling coefficient} \times \text{P (proportional bounds)}$$

Setting Range	Unit	Default
0.01 to 99.99	None	1.00



See

- Related parameter
“Proportional band” (adjustment level) (p. 5-14)

C-db

Dead band

The control system must be heating and cooling control.

This parameter sets the output dead band width in a heating and cooling control system. A negative setting sets an overlap band.



Function

- This parameter sets an area in which the control output is “0” centering around the set point in a heating and cooling control system.
- The decimal point setting follows the currently set sensor. During analog input, the decimal point setting follows the “decimal point position” setting.

Setting Range	Unit	Default
-199.9 to 999.9	EU	0.0

Adjustment Level

0F-r

Manual reset value

The control must be either standard (heating) control and 2-PID control. The “integral time” parameter must be set to “0”.



Function

- This parameter sets the required manipulated variable to remove offset during stabilization of P or PD control.



Setting

Setting Range	Unit	Default
0.0 to 100.0	%	50.0



See

- Related parameters
 - “PID / ON/OFF” (initial setting level) (p. 5-21)
 - “Integral time” (adjustment level) (p. 5-14)

H45

Hysteresis (OUT1)

The control must be ON/OFF control.

CH45

Hysteresis (OUT2)

This parameter sets the hysteresis for ensuring stable operation at ON/OFF switching.



Function

- In a standard control, use the “hysteresis (OUT1)” parameter. The “hysteresis (OUT2)” parameter cannot be used.
- In a heating and cooling control, the hysteresis can be set independently for heating and cooling. Use the “hysteresis (OUT1)” parameter to set the control output 1 side hysteresis, and use the “hysteresis (OUT2)” parameter to set the control output 2 side hysteresis.
- The decimal point setting follows the currently set sensor. During analog input, the decimal point setting follows the “decimal point position” setting.



Setting

Setting Range	Unit	Default
0.1 to 999.9	EU	1.0



See

- Related parameter
 - “PID / ON/OFF” (initial setting level) (p. 5-21)

Initial Setting Level

This level is for setting up the basic specifications of the E5GN. In this level, you can set the “input type” parameter for selecting the sensor input to be connected to the E5GN, limit the setting range of set values or set the alarm mode.

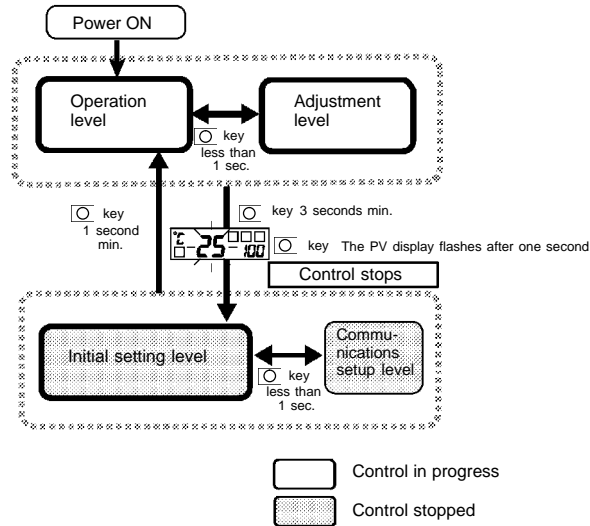

To move from the operation level to the initial setting level, press key for three seconds or more.

- The initial setting level is not displayed when “initial/communications protection” is set to “2”. This initial setting level can be used when “initial setting/communications protection” is set to “0” or “1”.
- The “scaling upper limit”, “scaling lower limit” and “decimal point” parameters are displayed when analog input is selected as the input type.

Initial setting level		Page
<input type="checkbox"/> $\bar{L}n-t$ $\square\square\square$	Input type	5-18
<input type="checkbox"/> $\bar{L}n-H$ $\square\square\square$	Scaling upper limit	5-19
<input type="checkbox"/> $\bar{L}n-L$ $\square\square\square$	Scaling lower limit	5-19
<input type="checkbox"/> dP $\square\square$	Decimal point	5-19
<input type="checkbox"/> $d-U$ $\square\square$	*C/*F selection	5-20
<input type="checkbox"/> $\bar{S}L-H$ $\square\square\square$	Set point upper limit	5-20
<input type="checkbox"/> $\bar{S}L-L$ $\square\square\square$	Set point lower limit	5-20
<input type="checkbox"/> $\bar{L}ntL$ $\square\square\square$	PID / ON/OFF	5-21
<input type="checkbox"/> $\bar{S}HL$ $\square\square\square$	Standard/heating and cooling	5-21
<input type="checkbox"/> $\bar{S}t$ $\square\square$	ST	5-22
<input type="checkbox"/> $\bar{L}P$ $\square\square\square$	Control period (OUT1)	5-22
<input type="checkbox"/> $\bar{L}-\bar{L}P$ $\square\square\square$	Control period (OUT2)	5-22
<input type="checkbox"/> $\bar{a}rEu$ $\square\square\square$	Direct/reverse operation	5-23
<input type="checkbox"/> $\bar{A}Lt 1$ $\square\square$	Alarm 1 type	5-23
<input type="checkbox"/> $\bar{A}n\bar{a}u$ $\square\square\square$	Move to advanced function setting level	5-25

Initial Setting Level

Ln-t

Input type



Function

- This parameter sets the sensor type by a corresponding code.
- When this parameter is changed, the set point upper limit is changed to the default. If the set point limits must be changed, set the “set point upper limit” and “set point lower limit” parameters (initial setting level).



Setting

- Set the code according to the following table. Shaded ranges indicate default settings. The defaults are as follows.

Platinum resistance thermometer: “0”: platinum resistance thermometer Pt100

Thermocouple: “0”: K thermocouple

	Input type	Name	Set Value	Input Temperature Range
Platinum resistance thermometer	Platinum resistance thermometer	Pt100	0	-200 to 850 (°C) / -300 to 1500 (°F)
			1	-199.9 to 500.0 (°C) / -199.9 to 900.0 (°F)
			2	0.0 to 100.0 (°C) / 0.0 to 210.0 (°F)
		JPt100	3	-199.9 to 500.0 (°C) / -199.9 to 900.0 (°F)
			4	0.0 to 100.0 (°C) / 0.0 to 210.0 (°F)

	Input type	Name	Set Value	Input Temperature Range	
Thermocouple input type	Thermocouple	K	0	-200 to 1300 (°C) / -300 to 2300 (°F)	
			1	-20.0 to 500.0 (°C) / 0.0 to 900.0 (°F)	
		J	2	-100 to 850 (°C) / -100 to 1500 (°F)	
			3	-20 to 400.0 (°C) / 0.0 to 750.0 (°F)	
		T	4	-200 to 400 (°C) / -300 to 700 (°F)	
			17	-199.9 to 400.0 (°C) / -199.9 to 700.0 (°F)	
		E	5	0 to 600 (°C) / 0 to 1100 (°F)	
		L	6	-100 to 850 (°C) / -100 to 1500 (°F)	
		U	7	-200 to 400 (°C) / -300 to 700 (°F)	
			18	-199.9 to 400.0 (°C) / -199.9 to 700.0 (°F)	
		N	8	-200 to 1300 (°C) / -300 to 2300 (°F)	
	R	9	0 to 1700 (°C) / 0 to 3000 (°F)		
	S	10	0 to 1700 (°C) / 0 to 3000 (°F)		
	B	11	100 to 1800 (°C) / 300 to 3200 (°F)		
	Non-contact temperature sensor ES1A	Non-contact temperature sensor ES1A	K10 to 70°C	12	0 to 90 (°C) / 0 to 190 (°F)
			K60 to 120°C	13	0 to 120 (°C) / 0 to 240 (°F)
K115 to 165°C			14	0 to 165 (°C) / 0 to 320 (°F)	
K160 to 260°C			15	0 to 260 (°C) / 0 to 500 (°F)	
Analog input	Analog input	0 to 50mV	16	One of following ranges depending on the results of scaling: -1999 to 9999, -199.9 to 999.9,	



See

- Related parameters
“°C/°F selection” “Set point upper limit” “Set point lower limit” (initial setting level) (p. 5-20)

Initial Setting Level

Ln-H

Scaling upper limit

The input type must be set to analog input.

Ln-L

Scaling lower limit

dp

Decimal point



Function

- These parameters can be used when voltage input is selected as the input type.
- When voltage input is selected as the input type, scaling is carried out. Set the upper limit in the “scaling upper limit” parameter and the lower limit in the “scaling lower limit” parameter.
- The “decimal point” parameter specifies the decimal point position of parameters (set point, etc.) whose unit is set to EU.



Setting

- Scaling upper limit, Scaling lower limit

Parameter	Setting Range	Unit	Default
Scaling upper limit	Scaling lower limit +1 to 9999	None	100
Scaling lower limit	-1999 to scaling upper limit -1	None	0

- Decimal point: Default is “0: 0 digits past decimal point”

Set value	Setting	Example
0	0 digits past decimal point	1234
1	1 digit past decimal point	123.4



See

- Related parameter
“Input type” (initial setting level) (p. 5-18)

Initial Setting Level

d-U

°C/°F selection

The input type must be set to temperature input.



Function

- Set the temperature input unit to either of “°C” or “°F”.



Setting

Setting Range	Default
[: °C / F : °F	[



See

- Related parameter
“Input type” (initial setting level) (p. 5-18)

5L-H

Set point upper limit

5L-L

Set point lower limit



Function

- This parameter limits the upper and lower limits when the SP is set. The SP can be set within the range defined by the upper and lower limit set values in the “set point upper limit” and “set point lower limit” parameters. The existing SP settings that are out of the range are forcibly changed to one of the upper or lower limit values (whichever is closest).
- When the temperature input type and temperature unit have been changed, the set point upper limit and set point lower limit are forcibly changed to the upper and lower limits of the sensor.
- During temperature input, the decimal point position is dependent on the currently selected sensor. During analog input, it is dependent on the “decimal point” parameter setting.



Setting

Parameter	Setting Range	Unit	Default
Set point upper limit	Set point lower limit +1 to sensor range upper limit	EU	1300
	Platinum resistance thermometer	EU	850
Set point lower limit	Sensor range lower limit to set point upper limit -1	EU	-200



See

- Related parameters
“Input type” (p. 5-18) “°C/°F selection” (p. 5-20) (initial setting level)

EntL

PID / ON/OFF



Function

- This parameter selects 2-PID control or ON/OFF control.
- The AT and ST tuning functions can be used in 2-PID control.



Setting

Setting Range	Default
PiLd : 2-PID / OnOff: ON/OFF	OnOff



See

- Related parameters
 - “AT execute/cancel” (p. 5-11) “Manual reset” “Hysteresis (OUT1)” (p. 5-16) (adjustment level)
 - “ST stable range” (advanced function setting level) (p. 5-30)

5-HC

Standard/heating and cooling

The E5GN must support alarm 1 output.



Function

- This parameter selects standard control or heating and cooling control as control output 2.
- When heating and cooling control is selected, the alarm 1 output terminal “ALM1” is used for cooling side output. Therefore, alarm 1 cannot be used.

Setting Range	Default
5Lnd : Standard / H-C : Heating and cooling	5Lnd



See

- Related parameters
 - “MV monitor (OUT1)” “MV monitor (OUT2)” (operation level) (p. 5-8, 9)
 - “Alarm value” (p. 5-7) “Upper-limit alarm value 1” “Lower-limit alarm value 1” (operation level) (p. 5-8)
 - “Hysteresis (OUT2)” (p. 5-16) “Cooling coefficient” “Dead band” (p. 5-15) (adjustment level)
 - “Control period (OUT2)” (initial setting level) (p. 5-22)
 - “Alarm 1 type” (initial setting level) (p. 5-23)
 - “Alarm 1 hysteresis” (p. 5-29) “Alarm 1 open in alarm” (p. 5-29) (advanced function setting level)

Initial Setting Level

St

ST self-tuning

The control must be either standard control, temperature input and 2-PID control.



Function

- The ST (self-tuning) function executes tuning from the start of program execution to calculate PID constants matched to the control target. When the ST function is in operation, be sure to turn the power supply of the load connected to the control output ON simultaneously with or before starting operation of the E5GN.



Setting

Parameter	Setting Range	Unit	Default
ST	ōFF: ST function OFF / ōn : ST function ON	None	ōn



See

- Related parameters
 - “ST stable range” (advanced function setting level) (p. 5-30)
 - “Input type” (p. 5-18) “PID / ON/OFF” (initial setting level) (p. 5-21)

CP

Control period (OUT1)

The control must be set to 2-PID control.

C-CP

Control period (OUT2)



Function

- This parameter sets the output period. Set the control period taking the control characteristics and the electrical life expectancy of the relay into consideration.
- In a standard control system, use the “control period (OUT1)” parameter. The “control period (OUT2)” parameter cannot be used.
- In a heating and cooling control system, the control period can be set independently for heating and cooling. Use the “control period (OUT1)” parameter to set the heating side control period, and use the “control period (OUT2)” parameter to set the cooling side control period.



Setting

Parameter	Setting Range	Unit	Default
Control period (OUT1)	1 to 99	Second	20
Control period (OUT2)	1 to 99	Second	20



See

- Related parameter
 - “PID / ON/OFF” (initial setting level) (p. 5-21)

Initial Setting Level

ā r ē u

Direct/reverse operation



Function

- “Direct operation” refers to control where the manipulated variable is increased according to the increase in the process value. Alternatively, “reverse operation” refers to control where the manipulated variable is increased according to the decrease in the process value.



Setting

Setting Range	Default
ā r - r : Reverse operation / ā r - d : Direct operation	ā r - r

AL1

Alarm 1 type

The alarm 1 type must be supported.
The control must be set to standard control.



Function

- Select one of the following alarm 1 types:
Deviation/Deviation range/Absolute value

Initial Setting Level



Setting

Set Value	Alarm Type	Alarm Output Operation	
		When X is positive	When X is negative
0	Alarm function OFF	Output OFF	
*1 1	Upper- and lower-limit (deviation)		*2
2	Upper-limit (deviation)		
3	Lower-limit (deviation)		
*1 4	Upper- and lower-limit range (deviation)		*3
*1 5	Upper- and lower-limit with standby sequence (deviation)		*4
6	Upper-limit with standby sequence (deviation)		
7	Lower-limit with standby sequence (deviation)		
8	Absolute-value upper-limit		
9	Absolute-value lower-limit		
10	Absolute-value upper-limit with standby sequence		
11	Absolute-value lower-limit with standby sequence		

*1 : The upper- and lower-limit values, expressed as "L" and "H", can be set independently for each alarm point with set values 1, 4 and 5.

*2 : Set value : 1 Upper- and lower-limit alarm

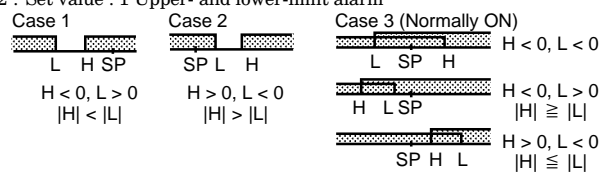

*3 : Set value : 4 Upper- and lower-limit range

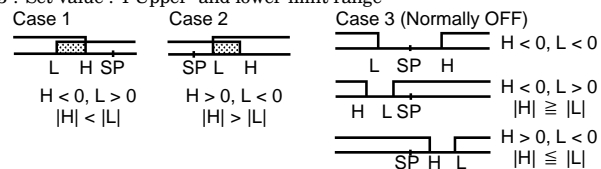

*4 : Set value : 5 Upper- and lower-limit alarm with standby sequence

*For the above upper- and lower-limit alarm

- In cases 1 and 2, the alarm is normally OFF if upper- and lower-limit values of hysteresis overlap.

- In case 3, the alarm is normally OFF.

*5 : Set value : 5 Upper- and lower-limit alarm with standby sequence

The alarm is normally OFF if upper- and lower-limit values of hysteresis overlap.

- Set the alarm type in the "alarm 1 type" parameter (initial setting level). Default is "2: upper-limit alarm".



See

● Related parameters

"Alarm value 1" (operation level) (p. 5-7)

"Upper limit alarm value 1" "Lower limit alarm value 1" (operation level) (p. 5-8)

"Standby sequence reset method" (p. 5-28) "Alarm 1 open in alarm" "Alarm 1 hysteresis" (p. 5-29) "Alarm 1 latch" (p. 5-34) (advanced function setting level)

Advanced Function Setting Level

INIT

Parameter initialize



Function

This parameter returns parameter settings to their defaults.



Setting

ON : Initializes all parameters.

OFF : Turns the E5GN OFF after returning parameter settings to their defaults.

ASPU

Multi-SP uses



Function

When the “multi-SP” parameter is set to “ON”, you can select set points 0 to 3 by operating the keys on the front panel of the controller.



Setting

ON : You can select set points 0 to 3.

OFF : You cannot select set points 0 to 3.

- Default : OFF.



See

● Related parameter

“Multi-SP” (operation level) (p. 5-5)

Advanced Function Setting Level

SPrt

SP ramp set value

ST (self-tuning) must be set to "OFF".



Function

- This parameter specifies the change rate during SP ramp operation. Set the maximum permissible change width per unit of time (minute) as the "SP ramp set value". However, note, that when the "SP ramp set value" is set to "OFF", the SP ramp function is disabled.
- The SP ramp set value is independent of the time unit. When setting "30 per minute" as the "SP ramp set value," set the "SP ramp set value" parameter to "30".
- During temperature input, the decimal point position of the SP ramp set value is dependent on the currently selected sensor, and during analog input it is dependent on scaling.



Setting

Parameter	Setting Range	Unit	Default
SP ramp set value	OFF, 1 to 9999	EU	0FF



See

- Related parameters
"Input type" (p. 5-18) "Scaling upper limit" "Scaling lower limit" "Decimal point" (p. 5-19) "ST" (initial setting level) (p. 5-22)

Advanced Function Setting Level



Standby sequence reset method

The alarm 1 type must be set to “with standby sequence.”



Function

- This parameter selects the conditions for enabling reset after the standby sequence of the alarm has been canceled.
Output is turned OFF when the initial setting level, communications setting level, advanced function setting level or calibration level is switched to.
- Condition A:
Control started (including power ON), and set point, alarm value (upper/lower-limit alarm value) or input shift value (upper/lower-limit temperature input shift value) changed
- Condition B:
Power ON
- The following example shows the reset action when the alarm type is lower-limit alarm with standby sequence.

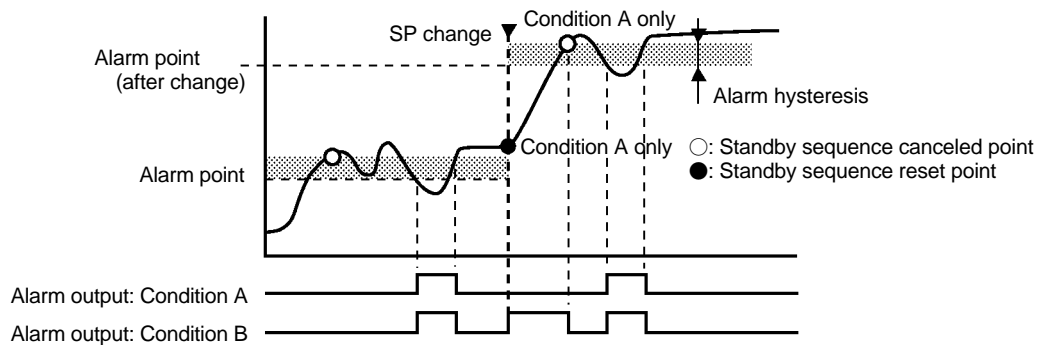

Setting

Setting Range	Default
\bar{A} : Condition A / \bar{b} : Condition B	\bar{A}



See

- Related parameter
 “Alarm 1 type” (initial setting level) (p. 5-23)
 “Alarm 1 latch” (advanced setting level) (p. 5-34)

Advanced Function Setting Level

AL 1n

Alarm 1 open in alarm

E5GN-□1□ must be used.
The control must be set to standard control.



Function

- This parameter sets the output states of alarm 1.
- When the E5CN is set to “close in alarm,” the status of the alarm output function is normally open. When set to “open in alarm,” the status of the alarm output is output inverted, or normally closed. The following table shows the relationship between alarm output functions, alarm output and output LCDs. When “alarm 1 open in alarm” is set to “open in alarm”, the heater burnout alarm and input error output also become “open in alarm.”



Setting

	Alarm Output Function	Alarm Output	Output LCDs
Close in alarm	ON	ON	Lit
	OFF	OFF	Out
Open in alarm	ON	OFF	Lit
	OFF	ON	Out

Setting Range	Default
n-5 : Close in alarm / n-7 : Open in alarm	n-5



See

- Related parameters
 - “Alarm value 1” (p. 5-7) “Upper-limit alarm value 1” “Lower-limit alarm value 1” (p. 5-8) (operation level)
 - “Alarm 1 type” (initial setting level) (p. 5-23)
 - “Alarm 1 hysteresis” (p. 5-29) “Standby sequence reset method” (p. 5-28) “Alarm 1 latch” (p. 5-34) (advanced function setting level)

ALH 1

Alarm 1 hysteresis

E5GN-□1□ must be used.
The control must be set to standard control.



Function

- This parameter sets the hysteresis of alarm output 1.
- During analog input, the decimal point setting follows the “decimal point position” setting.



Setting

Setting Range	Unit	Default
0.1 to 999.9	°C or °F	0.2



See

- Related parameters
 - “Alarm value 1” (p. 5-7) “Upper-limit alarm value 1” “Lower-limit alarm value 1” (p. 5-8) (operation level)
 - “Alarm 1 type” (initial setting level) (p. 5-23)
 - “Alarm 1 open in alarm” (p. 5-29) “Standby sequence reset method” (p. 5-28) “Alarm 1 latch” (p. 5-34) (advanced function setting level)

Advanced Function Setting Level

St-b

ST stable range

The control must be set to temperature input, PID control and ST set to "ON".



Function

- This parameter sets the set value for determining the conditions under which ST (self-tuning) occurs. This parameter cannot be used when the "ST" parameter is set to "OFF".



Setting

Setting Range	Unit	Default
0.1 to 999.9	°C or °F	15.0



See

- Related parameters
 - "PID / ON/OFF" (initial setting level) (p. 5-21)
 - "Input type" (initial setting level) (p. 5-18)
 - "ST" (initial setting level) (p. 5-22)

ALFA

α

The control must be 2-PID control, and the "ST" parameter must be set to "OFF".



Function

- Normally, use this parameter at its default.
- This parameter sets 2-PID-constant α .



Setting

Setting Range	Unit	Default
0.00 to 1.00	None	0.65



See

- Related parameters
 - "PID / ON/OFF" (initial setting level) (p. 5-21)
 - "ST" (initial setting level) (p. 5-22)

Advanced Function Setting Level

OL-H

MV upper limit

The control must be 2-PID control, and the "ST" parameter must be set to "OFF".

OL-L

MV lower limit



Function

- The "MV upper limit" and "MV lower limit" parameters set the upper and lower limits of the manipulated variable. When the manipulated variable calculated by E5GN exceeds the upper or lower limit value, the upper or lower limit set becomes the output level.



Setting

- **MV upper limit**
The setting ranges during standard control and heating and cooling control are different.
The manipulated variable at the control output 2 side during heating and cooling control is expressed as a negative value.

Control Method	Setting Range	Unit	Default
Standard (heating)	MV lower limit +0.1 to 105.0	%	105.0
Heating and cooling	0.0 to 105.0	%	105.0

- **MV lower limit**
The setting ranges during standard control and heating and cooling control are different.
The manipulated variable at the control output 2 side during heating and cooling control is expressed as a negative value.

Control Method	Setting Range	Unit	Default
Standard (heating)	-5.0 to MV upper limit -0.1	%	-5.0
Heating and cooling	0.0 to 105.0	%	105.0



See

- **Related parameters**
"PID / ON/OFF" (initial setting level) (p. 5-21)
"ST" (initial setting level) (p. 5-22)

Advanced Function Setting Level

INF

Input digital filter



Function

- Sets the time constant of the input digital filter. The following figure shows the effect on data after passing through the digital filter:

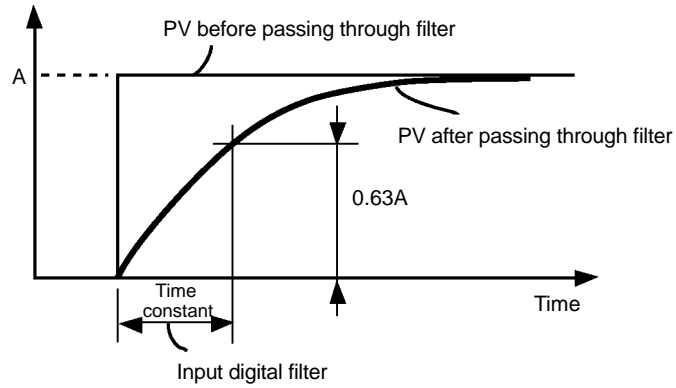

Setting

Setting Range	Unit	Default
0.0 to 999.9	Second	0.0

PVAd

Additional PV display



Function

- This parameter adds the facility of displaying only the PV. It is added to the top of the operation level. It is used to give the option of displaying the PV and SP or just the PV only.



Setting

Setting Range	Default
000 : Displayed / 0FF : Not displayed	0FF

Advanced Function Setting Level

̄-dP

Manipulated variable display



Function

This parameter displays the manipulated variable.

The manipulated variable is displayed when the “manipulated variable monitor” parameters are set to “ON”, and not displayed when these parameters are set to “OFF”.



Setting

Setting Range	Default
̄on : Displayed / ̄FF : Not displayed	̄FF

rEt

Automatic return of display mode



Function

- If you do not operate any of the keys on the front panel for the time set by this parameter in the “operation level” and “adjustment level”, the display automatically returns to the PV/SP display.
- This function is disabled (display does not change automatically) when this parameter is set to “OFF”.



Setting

Setting Range	Unit	Default
OFF, 1 to 99	Second	̄FF

Advanced Function Setting Level

A1L

Alarm 1 latch

The alarm 1 function must be ON.



Function

- When this setting is set to “ON”, the alarm function is held until the power is turned OFF once the alarm function has turned ON.
Note, however, that the latch is canceled when the initial setting level, advanced function setting level or calibration level is switched to.
- When alarm output function is set to open in alarm, closed output is held, and set to closed in alarm, open output is held.



Setting

Setting Range	Default
$\bar{a}n$: ON / $\bar{a}FF$: OFF	$\bar{a}FF$



See

- Related parameters
 - “Alarm value 1 ” (operation level) (p. 5-7)
 - “Upper–limit alarm value 1 ” “Lower–limit alarm value 1” (operation level) (p. 5-8 and 5-9)
 - “Alarm 1 type” (initial setting level) (p. 5-23)
 - “Standby sequence reset method” (advanced function setting level) (p. 5-28)
 - “Alarm 1 open in alarm” “Alarm 1 hysteresis” (advanced function setting level” (p. 5-29)

P1L

Protect level move time



Function

- Sets the key pressing time required for moving to the protect level from the operation level or the adjustment level.



Setting

Setting Range	Unit	Default
1 to 30	Second	3



See

- Related parameters
 - “Operation/adjustment protection” “Initial setting/communications protection”
 - “Setting change protection” (protect level) (p. 5-3)

Advanced Function Setting Level

SE-0

Output input error

The alarm 1 type must be supported.
The control must be set to standard control.



Function

- When this setting is set to “ON”, alarm 1 output becomes ON at an input error. Note, however, that the alarm 1 operation display does not light.
- The alarm 1 output is the ORed output of alarm 1, HBA used and input error.
- Output is turned OFF when the initial setting level, communications setting level, advanced function setting level or calibration level is switched to.



Setting

Setting Range	Default
$\bar{0}n$: ON / $\bar{0}FF$: OFF	$\bar{0}FF$



See

- Related parameter
“Input error” (error display) (p. A-4)

00

Cold junction compensation method

Input type must be thermocouple or non-contact temperature sensor



Function

- Specifies whether cold junction compensation is to be performed internally by the controller or to be performed externally when the input type setting value is No.0 to 15, 17 or 18.
- The cold junction compensation external setting is valid when the temperature difference is measured using two thermocouples or two ESIAs.



Setting

Setting Range	Default
$\bar{0}n$: internally / $\bar{0}FF$: externally	$\bar{0}n$



See

- Related parameter
“Input type” (initial setting level) (p. 5-18)

Communications Setting Level



MB command logic switching

Communications function must be supported.



Function

- Switches the logic of MB command (communications writing switching) in the Sysway communications procedures.
- The MB command (communications writing switching) is equivalent to the MB command (remote/local switching) on the E5□J.



Setting

- The hatched setting is the default (same logic as E5□J).

Setting Value	Text Data of MB Command	
	0000	0001
OFF	Communications writing enabled (remote mode selection)	Communications writing disabled (local mode selection)
ON	Communications writing disabled (local mode selection)	Communications writing enabled (remote mode selection)

(Terms in parentheses () are the terms used on the E5□J.)



See

- Related parameter
“Communications writing” (adjustment level) (p. 5-11)

Advanced Function Setting Level

U-nō

Communications unit No.

Communications function must be supported.

bPS

Baud rate

LEn

Communications data length

Sbct

Communications stop bit

Prty

Communications parity



Function

- Each parameter is enabled when the power is reset.
- Match the communications specifications of the E5GN and the host computer. If a 1 : N connection is being used, ensure that the communications specifications for all devices in the system (except “Communications unit No.”) are the same.



Setting

Parameter	Displayed Characters	Set Value	Setting Range
Communications unit No.	U-nō	0, 1 to 99	0 to 99
Baud rate	bPS	1.2 / 2.4 / 4.8 / 9.6 / 19.2 (kbps)	1.2 / 2.4 / 4.8 / 9.6 / 19.2 (kbps)
Communications data length	LEn	7 / 8 (bit)	7 / 8 (bit)
Communications stop bit	Sbct	1 / 2	1 / 2
Communications parity	Prty	nōnE / EvEn / odd	None / even / odd

Highlighted characters indicate defaults.



See

- Related parameters
“Communications writing” (adjustment level) (p. 5-11)

CHAPTER 6

CALIBRATION

6.1	Parameter Structure	6-2
6.2	User Calibration	6-3
6.3	Calibrating Thermocouples	6-4
6.4	Calibrating Analog Input	6-7
6.5	Calibrating Platinum Resistance Thermometers	6-8
6.6	Checking Indication Accuracy	6-9

6.1 Parameter Structure

- To calibrate the E5GN, enter the password “1201” at the “move to calibration level” parameter in the “advanced function setting level”. “Adj” is displayed.
- However, note that the “move to calibration level” parameter might not be displayed when, for example, the user is calibrating the E5GN for the first time. If this happens, set the “initial/communications protection” parameter in the protect level to “0” before moving to the “advanced function setting level”.
- The calibration mode is quit by turning the power OFF.
- The parameters in the calibration level are structured as follows:

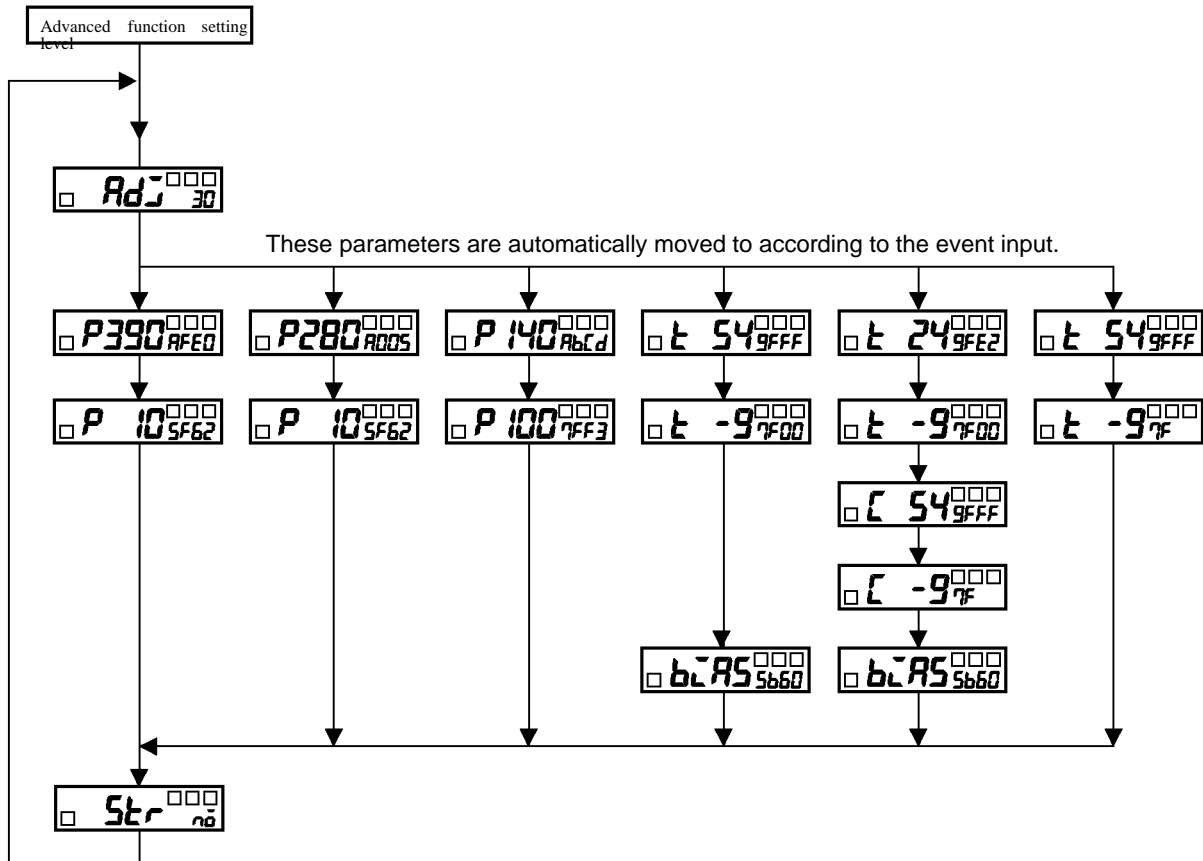

Once the user has calibrated the E5GN, a dot will be displayed when the calibration level is moved to, to indicate that the E5GN has already been calibrated by the user.



Dot is displayed.

6.2 User Calibration

The E5GN is correctly calibrated before it is shipped from the factory, and normally need not be calibrated by the user.

If, however, it must be calibrated by the user, use the parameters for calibrating temperature input and analog input.

However, note that OMRON cannot ensure the results of calibration by the user.

Also, calibration data is overwritten with the latest settings. The default calibration settings cannot be returned to after user calibration.

● Calibrating input

When the user calibrates the E5GN, the input type currently selected in parameters is calibrated. The following 24 input types can be calibrated.

- Thermocouple : 14 types
- Non-contact temperature sensor : 4 type
- Analog input : 1 type
- Platinum resistance thermometer : 5 types

● Registering calibration data

The new calibration data for each item is temporarily registered. It can be officially registered as calibration data only when all items have been calibrated to new values. So, be sure to temporarily register all items when you calibrate the E5GN.

When calibration data is registered, it is registered regardless of whether or not the E5GN has been calibrated by the user.

Prepare separate measuring devices and equipment for calibration. For details on how to handle measuring devices and equipment, refer to the respective instruction manuals.

6.3 Calibrating Thermocouples

- Calibrate according to the type of thermocouple, thermocouple 1 group (input types 0, 2, 5, 6, 8) and thermocouple 2 group (input types 1, 3, 4, 7, 9, 10, 11, 12, 13, 14, 15, 17, 18).
- When calibrating, do not cover the bottom of the E5GN. Also, do not touch the input terminals (Nos. 8 and 9) or compensating conductor on the E5GN.

● Preparations

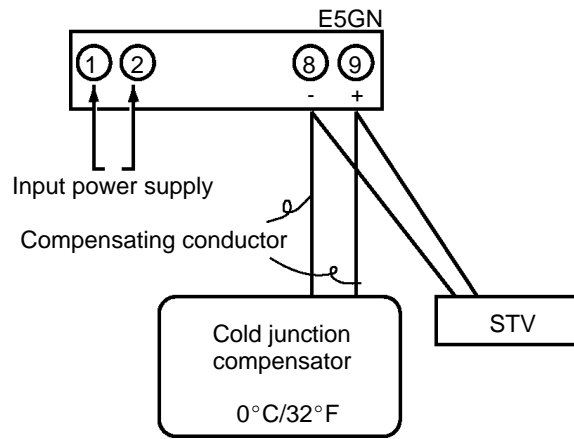

- Set the cold junction compensator designed for compensation of internal thermocouples to 0°C. However, make sure that internal thermocouples are disabled (tips are open).
- In the above figure, STV refers to a standard DC current/voltage source.
- Use the compensating conductor designed for the selected thermocouple. However, note that when thermocouples R, S, E, B or a non-contact temperature sensor is used, the cold junction compensator and the compensating conductor can be substituted with the cold junction compensator and the compensating conductor for thermocouple K.



Connecting the Cold Junction Compensator

Correct process values cannot be obtained if you touch the contact ends of the compensating conductor during calibration of a thermocouple. Accordingly, short-circuit (enable) or open (disable) the tip of the thermocouple inside the cold junction compensator as shown in the figure below to create a contact or non-contact state for the cold junction compensator.

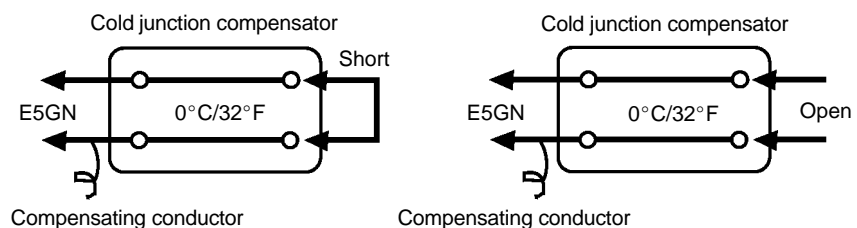

This example describes how to calibrate the E5GN when thermocouple input is currently selected on an E5GN supporting thermocouple input.

- (1) Connect the power supply.
- (2) Connect a standard DC current/voltage source (STV), precision digital multimeter (DMM) and contact junction compensator (e.g. zero controller as in figure) to the thermocouple input terminals, as shown in the figure below.

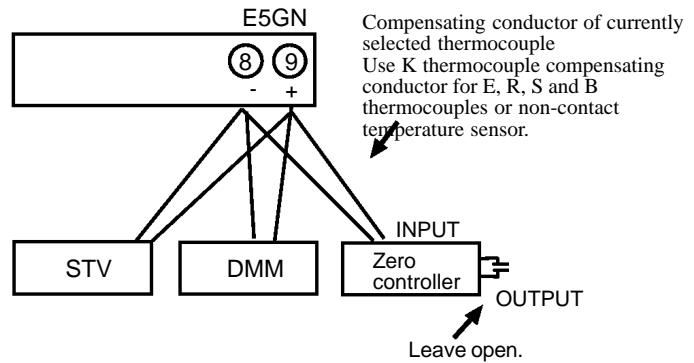

- (3) Turn the power ON.
- (4) Move to the calibration level.
This starts the 30-minute aging timer. This timer provides an approximate timer for aging. After 30 minutes, the No.2 display changes to "0". You can advance to the next step in this procedure even if "0" is not displayed.

□ Adj □□□□ 30

Input types 0, 2, 5, 6, 8

□ t 54 □□□□

Input types, 1, 3, 4, 7,
9, 10, 11, 12, 13, 14,
15, 17, 18

□ t 24 □□□□

- (5) Press the  key to set the E5GN to the state on the left.

The No.2 display at this time displays the currently entered count value entered in Hexadecimal. Set the STV as follows:

- Input types 0, 2, 5, 6, 8 : Set to "54 mV".
- Input types 1, 3, 4, 7, 9, 10, 11, 12, 13, 14, 15, 17, 18: Set to "24 mV".

Allow the count value on the No.2 display to fully stabilize, then press the  key to temporarily register the calibration setup.

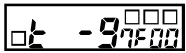

- (6) Press the key to set the E5GN to the state on the left. Set STV to “-9mV”.

Allow the count value on the No.2 display to fully stabilize, then press the key to temporarily register the calibration setup. (Input types 0, 2, 5, 6, 8 : Go to step 11.)

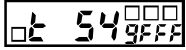

- (7) Press the key. The No.2 display changes to the state on the left when the input type is 1, 3, 4, 7, 9, 10, 11, 12, 13, 14 or 15.

- (8) Set STV to “54mV”.

Allow the count value on the No.2 display to fully stabilize, then press the key to temporarily register the calibration setup.

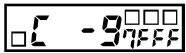

- (9) Press the key. The No.2 display changes to the state on the left when the input type is 1, 3, 4, 7, 9, 10, 11, 12, 13, 14, 15, 17 or 18. Set STV to “-9mV”.

- (10) Allow the count value on the No.2 display to fully stabilize, then press the key to temporarily register the calibration setup.

- (11) Press the key to set the E5GN to the state on the left.

- (12) Change the wiring as follows:

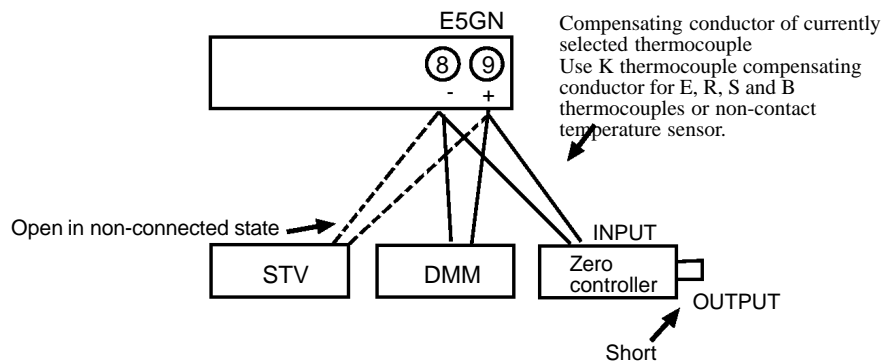

Disconnect the STV to enable the thermocouple of the cold junction compensator. When doing this, be sure to disconnect the wiring on the STV side.

- (13) Allow the count value on the No.2 display to fully stabilize, then press the key to temporarily register the calibration setup.

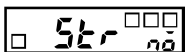

- (14) Press the key. The No.2 display changes to the state on the left. Note that the data to be temporarily registered is not displayed when it is not entirely prepared.

Press the key. The No.2 display changes to “54.5”. Release the key and wait two seconds or press the key. This stores the temporarily registered calibration data to EEPROM. To cancel storage of temporarily registered calibration data to memory, press the key without pressing the key.

- (15) The calibration mode is quit by turning the power OFF.

6.4 Calibrating Analog Input

This example describes how to calibrate when 0 to 50 mV input (input type 16) is currently selected on an E5GN supporting thermocouple input.

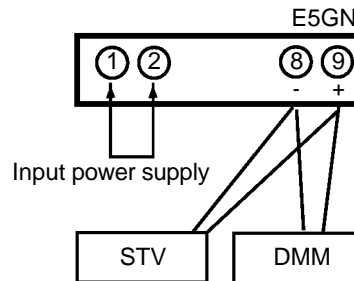

- (1) Connect the power supply.
- (2) Connect an STV and DMM to the analog input terminals, as shown in the figure above.
- (3) Turn the power ON.
- (4) Move to the calibration level.

Adj 30

This starts the 30-minute aging timer. This timer provides an approximate timer for aging. After 30 minutes, the No.2 display changes to "0". You can advance to the next step in this procedure even if "0" is not displayed.

549FFF

- (5) Press the key to set the E5GN to the state on the left. The No.2 display at this time displays the currently entered count value entered in Hexadecimal. Set the STV to "54mV".
- (6) Allow the count value on the No.2 display to fully stabilize, then press the key to temporarily register the calibration setup.

-97F00

- (7) Press the key to set the E5GN to the state on the left. Set STV to "-9mV".

5Er na

- (8) Allow the count value on the No.2 display to fully stabilize, then press the key to temporarily register the calibration setup.
- (9) Press the key. The No.2 display changes to the state on the left. Note that the data to be temporarily registered is not displayed when it is not entirely prepared.

Press the key. The No.2 display changes to "5E5". Release the key and wait two seconds or press the key. This stores the temporarily registered calibration data to EEPROM. To cancel storage of temporarily registered calibration data to memory, press the key without pressing the key.

- (10) The calibration mode is quit by turning the power OFF.

6.5 Calibrating Platinum Resistance Thermometers

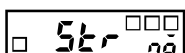
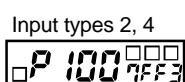
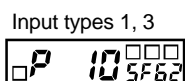
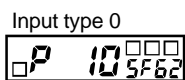
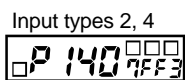
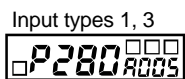
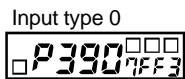
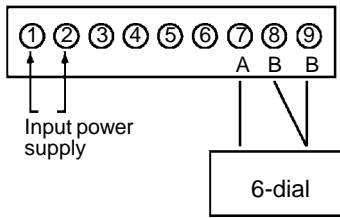

This example describes how to calibrate the E5GN when it is connected to a platinum resistance thermometer.

When calibrating a platinum resistance thermometer use wires of the same thickness as those used to connect the E5GN.

- (1) Connect the power supply.
- (2) Connect a precision resistance box (called “6-dial” in this manual) to the platinum resistance thermometer input terminals.
- (3) Turn the power ON.
- (4) Move to the “calibration level”.

This starts the 30-minutes aging timer. This timer provides an approximate timer for again. After 30 minutes, the No.2 display changes to “0”. You can advance to the next step in this procedure even if “0” is not displayed.

- (5) Press the key to display the count value for each input type. The No.2 display at this time displays the currently entered count value entered in Hexadecimal. Set the 6-dial as follows:

- Input type 0 : 390 Ω
- Input type 1 or 3 : 280 Ω
- Input type 2 or 4 : 140 Ω

- (6) Allow the count value on the No.2 display to fully stabilize, then press the key to temporarily register the calibration setup.

- (7) Press the key to set the E5GN to the state on the left.

Set the 6-dial as follows:

- Input type 0 : 10 Ω
- Input type 1 or 3 : 10 Ω
- Input type 2 or 4 : 100 Ω

- (8) Allow the count value on the No.2 display to fully stabilize, then press the key to temporarily register the calibration setup.

- (9) Press the key. The No.2 display changes to the state on the left. Note that the data to be temporarily registered is not displayed when it is not entirely prepared.

Press the key. The No.2 display changes to “YES”. Release the key and wait two seconds or press the key. This stores the temporarily registered calibration data to non-volatile memory (EEPROM). To cancel storage of temporarily registered calibration data to memory, press the key without pressing the key.

- (10) The calibration mode is quit by turning the power OFF.

6.6 Checking Indication Accuracy

● **Thermocouple or non contact temperature sensor**

- After calibrating input, be sure to check indication accuracy to make sure that the E5GN has been correctly calibrated.
- Operate the E5GN in the PV/SP monitor mode.
- Check the indication accuracy at the upper and lower limits and mid-point.

- **Preparation**
The following figure shows the required device connection. Make sure that the E5GN and cold junction compensator are connected by a compensating conductor for the thermocouple that is to be used during actual operation. For the non-contact temperature sensor, connect a K thermocouple, and set the input type to the K thermocouple.

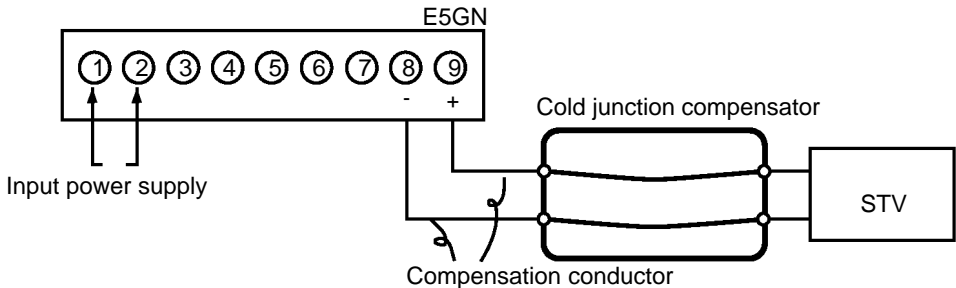

- **Operation**
Make sure that the cold junction compensator is at 0°C, and set STV output to the voltage equivalent to the starting power of the check value. The cold junction compensator and compensation conductor are not required when an external cold junction compensation method is used.

● **Platinum resistance thermometer**

- **Preparation**
The following figure shows the required device connection:

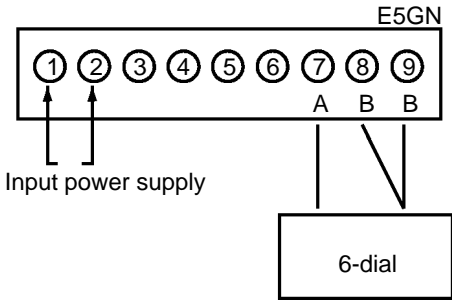

- **Operation**
Set the 6-dial to the resistance equivalent to the check value.

● **Analog input**

• Preparation

The following figure shows the required device connection:

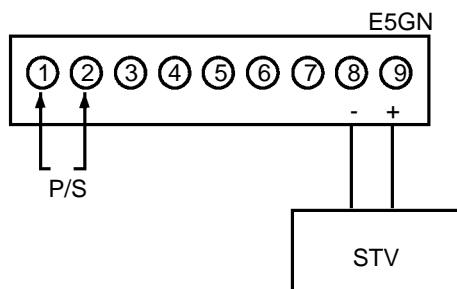

• Operation

Set the STV to the voltage equivalent to the check value.

APPENDIX

SPECIFICATIONS	A-2
Ratings	A-2
Characteristics	A-3
ERROR DISPLAY	A-4
PARAMETER OPERATIONS LIST	A-6
SENSOR INPUT SETTING, INDICATION AND CONTROL RANGES	A-10
SETUP LEVELS DIAGRAM	A-12
PARAMETER FLOW	A-13

SPECIFICATIONS

■ Ratings

Supply voltage	100 to 240 VAC, 50/60 Hz	24 VAC, 50/60 Hz/24 VDC
Operating voltage range	85 to 110% of rated supply voltage	
Power consumption	7VA	4VA/2.5W
Sensor input*	Thermocouple : K, J, T, E, L, U, N, R, S, B Platinum resistance thermometer : Pt100, JPt100 Non-contact temperature sensor : K10 to 70°C, K60 to 120°C, K115 to 165°C, K160 to 260°C Voltage input: 0 to 50 mV	
Control output	Relay output	SPST-NO, 250 VAC, 2A (resistive load), electrical life : 100,000 operations Min. applicable load 1V 1 mA
	Voltage output	Output voltage 12 VDC (PNP), max. load current 21 mA, with short-circuit protection circuit
Alarm output	SPST-NO, 250 VAC, 1A (resistive load), electrical life : 100,000 operations Min. applicable load 1V 1 mA	
Control method	2-PID or ON/OFF control	
Setting method	Digital setting using front panel keys	
Indication method	7-segment digital display and single-lighting indicator	
Other functions	According to controller model	
Ambient temperature	-10 to 55°C (with no condensation or icing)	
Ambient humidity	Relative humidity 25 to 85%	
Storage temperature	-25 to 65°C (with no condensation or icing)	
Altitude	2,000 m or less	
Recommended fuse	T2A, 250 VAC, time lag, low shut-off capacity	
Installation environment	Installation Category II, Pollution Class 2 (IEC 61010-1 compliant)	

* For the setting ranges for each input, see page A-10.

■ Characteristics

Indication accuracy	<p>Thermocouple: ($\pm 0.5\%$ of indication value or $\pm 1^\circ\text{C}$, whichever is greater) ± 1 digit max. (*1)</p> <p>Platinum resistance thermometer: ($\pm 0.5\%$ of indication value or $\pm 1^\circ\text{C}$, whichever is greater) ± 1 digit max.</p> <p>Analog input: $\pm 5\%FS \pm 1$ digit max.</p>
Temperature variation influence (*2)	<p>Thermocouple input (R, S, B): ($\pm 1\%$ of PV or $\pm 10^\circ\text{C}$, whichever greater) ± 1 digit max.</p> <p>Other thermocouple input: ($\pm 1\%$ of PV or $\pm 4^\circ\text{C}$, whichever greater) ± 1 digit max.</p> <p>*K thermocouple at -100°C max.: $\pm 10^\circ\text{C}$ max.</p>
Voltage variation influence (*2)	<p>Platinum resistance thermometer: ($\pm 1\%$ of PV or $\pm 2^\circ\text{C}$, whichever greater) ± 1 digit max.</p> <p>Analog input: ($\pm 1\%FS$) ± 1 digit max.</p>
Hysteresis	0.1 to 999.9EU (in units of 0.1EU)
Proportional band (P)	0.1 to 999.9EU (in units of 0.1EU)
Integral time (I)	0 to 3999 (in units of 1 second)
Derivative time (D)	0 to 3999 (in units of 1 second)
Control period	1 to 99 (in units of 1 second)
Manual reset value	0.0 to 100.0% (in units of 0.1%)
Alarm setting range	-1999 to 9999 (decimal point position dependent on input type)
Sampling period	500 ms
Insulation resistance	20 M Ω min. (by 500 VDC megger)
Dielectric strength	2000 VAC 50 or 60 Hz 1min
Malfunction vibration	10 to 55 Hz, 10 m/s ² for 10 min. each in X, Y and Z directions
Vibration resistance	300 10 to 55 Hz, 20 m/s ² for 2 hrs. each in X, Y and Z directions
Malfunction shock	200 m/s ² max. 3 times each in 3 axes, 6 directions (relay: 100 m/s ²)
Shock resistance	300 m/s ² max. 3 times each in 3 axes, 6 directions (relay: 100 m/s ²)
Weight	Approx. 90 g Adapter: approx. 10g
Protective structure	Front panel: NEMA4X for indoor use (equivalent to IP66), Rear case: IP20, terminals: IP00
Memory protection	EEPROM (non-volatile memory) (number of writes: 100,000)

*1 The indication of K thermocouples in the -200 to 1300°C range, T and N thermocouples at a temperature of -100°C or less, and U and L thermocouples at any temperature is $\pm 2^\circ\text{C} \pm 1$ digit maximum. The indication of B thermocouples at a temperature of 400°C or less is unrestricted.

The indication of R and S thermocouples at a temperature of 200°C or less is $\pm 3^\circ\text{C} \pm 1$ digit maximum.

*2 Ambient temperature: -10°C to 23°C to 55°C
Voltage range: -15% to $+10\%$ of rated voltage

ERROR DISPLAY

When an error has occurred, the No.1 display alternately indicates error codes together with the current display item.

This section describes how to check error codes on the display, and the actions you must take to remedy the problem.

Input error

● Meaning

The input value has exceeded the control range.

* Control range

Platinum resistance thermometer, thermocouple input	: Temperature setting lower limit -20°C to temperature setting upper limit $+20^{\circ}\text{C}$ (temperature setting lower limit -40°F to temperature setting upper limit $+40^{\circ}\text{F}$)
---	--

ESIA input	: Same as input indication range
------------	----------------------------------

Analog input	: -5% to 105% of scaling range
--------------	--------------------------------------

● Action

Check the wiring of inputs for miswiring, disconnections, and short-circuits and the input type.

If no abnormality is found in the wiring and input type, turn the power OFF then back ON again. If the display remains the same, the E5GN must be repaired. If the display is restored, then a probable cause can be electrical noise affecting the control system. Check for electrical noise.

● Operation at error

After the error occurs, the error is displayed, and control output functions turn OFF.

Alarm outputs function as if the upper limit value has been exceeded.

When “output input error” (advanced function level) is set to ON, the alarm 1 output turns ON when an input error occurs.

An error message is displayed when “process value” or “PV/SP” are displayed.

Memory error

● Meaning

Internal memory operation is in error.

● Action

First, turn the power OFF then back ON again. If the display remains the same, the E5GN must be repaired. If the display is restored, then a probable cause can be electrical noise affecting the control system. Check for electrical noise.

● Operation at error

Control output and alarm output turn OFF.

<div style="border: 1px solid black; width: 100%; height: 100%; display: flex; align-items: center; justify-content: center;"> cccc </div>	<h2>Display range over</h2>
<div style="border: 1px solid black; width: 100%; height: 100%; display: flex; align-items: center; justify-content: center;"> vvvv </div>	

● **Meaning**

Though this is not an error, this is displayed when the process value exceeds the display range when the control range is larger than the display range (-1999 (-199.9) to 9999 (999.9)).

- When less than “-1999” (-99.9) cccc
- When larger than “9999” (999.9) vvvv

● **Action**

Control continues, allowing normal operation. An error message is displayed when “process value” or “PV/SP” are displayed.

<p>RTD input (setting range: without -199.9 to 500.0(°C) type) Thermocouple input (setting range: without -199.9 to 400.0 (°C) type)</p> <table border="1" style="width: 100%; border-collapse: collapse; text-align: center;"> <tr> <th style="width: 20%;">S.Err indication</th> <th style="width: 60%;">Displayed by numerical value</th> <th style="width: 20%;">S.Err indication</th> </tr> <tr> <td></td> <td>Input indication range</td> <td></td> </tr> <tr> <td>-1999 (-199.9)</td> <td>← display range →</td> <td>9999 (999.9)</td> </tr> </table> <p>Analog input • display range < Displayed by numerical value</p> <table border="1" style="width: 100%; border-collapse: collapse; text-align: center;"> <tr> <th style="width: 15%;">S.Err indication</th> <th style="width: 15%;">cccc indication</th> <th style="width: 30%;">Displayed by numerical value</th> <th style="width: 15%;">cccc indication</th> <th style="width: 25%;">S.Err indication</th> </tr> <tr> <td></td> <td></td> <td>-1999 ← display → 9999 (-199.9) range (999.9)</td> <td></td> <td></td> </tr> <tr> <td colspan="5">Input indication range</td> </tr> </table> <p>Analog input • display range > Displayed by numerical value</p> <table border="1" style="width: 100%; border-collapse: collapse; text-align: center;"> <tr> <th style="width: 20%;">S.Err indication</th> <th style="width: 60%;">Displayed by numerical value</th> <th style="width: 20%;">S.Err indication</th> </tr> <tr> <td></td> <td>Input indication range</td> <td></td> </tr> <tr> <td>-1999 (-199.9)</td> <td>← display range →</td> <td>9999 (999.9)</td> </tr> </table>	S.Err indication	Displayed by numerical value	S.Err indication		Input indication range		-1999 (-199.9)	← display range →	9999 (999.9)	S.Err indication	cccc indication	Displayed by numerical value	cccc indication	S.Err indication			-1999 ← display → 9999 (-199.9) range (999.9)			Input indication range					S.Err indication	Displayed by numerical value	S.Err indication		Input indication range		-1999 (-199.9)	← display range →	9999 (999.9)	<p>RTD input (setting range: -199.9 to 500.0(°C) type) Thermocouple input (setting range: without -199.9 to 400.0 (°C) type)</p> <table border="1" style="width: 100%; border-collapse: collapse; text-align: center;"> <tr> <th style="width: 20%;">cccc indication</th> <th style="width: 60%;">Displayed by numerical value</th> <th style="width: 20%;">S.Err indication</th> </tr> <tr> <td></td> <td>Input indication range</td> <td></td> </tr> <tr> <td></td> <td>-1999 ← display range → 9999 (-199.9)</td> <td>9999 (999.9)</td> </tr> </table>	cccc indication	Displayed by numerical value	S.Err indication		Input indication range			-1999 ← display range → 9999 (-199.9)	9999 (999.9)
S.Err indication	Displayed by numerical value	S.Err indication																																									
	Input indication range																																										
-1999 (-199.9)	← display range →	9999 (999.9)																																									
S.Err indication	cccc indication	Displayed by numerical value	cccc indication	S.Err indication																																							
		-1999 ← display → 9999 (-199.9) range (999.9)																																									
Input indication range																																											
S.Err indication	Displayed by numerical value	S.Err indication																																									
	Input indication range																																										
-1999 (-199.9)	← display range →	9999 (999.9)																																									
cccc indication	Displayed by numerical value	S.Err indication																																									
	Input indication range																																										
	-1999 ← display range → 9999 (-199.9)	9999 (999.9)																																									

PARAMETER OPERATIONS LIST

Operation level

Parameter Name	Symbol	Setting (monitor) Value	Display	Default	Unit	Set Value
PV		Sensor input indication range			EU	
PV/SP		SP lower limit to SP upper limit		0	EU	
Multi-SP	$\bar{n} - SP$	0 to 3		0	None	
Set point during SP ramp	$SP - \bar{n}$	SP lower limit to SP upper limit			EU	
Run/stop	$r - S$	Run/stop	$rUn, St\bar{o}P$	Run	None	
Alarm value 1	$AL - 1$	-1999 to 9999		0	EU	
Upper-limit alarm value 1	$AL 1H$	-1999 to 9999		0	EU	
Lower-limit alarm value 1	$AL 1L$	-1999 to 9999		0	EU	
MV monitor (OUT1)	\bar{o}	0.0 to 100.0 (standard) 0.0 to 100.0 (heating and cooling)			%	
MV monitor (OUT2)	$\bar{c} - \bar{o}$	0.0 to 100.0			%	

Adjustment level

Parameter Name	Symbol	Setting (monitor) Value	Display	Default	Unit	Setting Value
AT execute/cancel	At	ON, OFF	$\bar{o}n, \bar{o}FF$	$\bar{o}FF$	None	
Communications writing	$\bar{c} \bar{n} \bar{w}r$	ON, OFF	$\bar{o}n, \bar{o}FF$	$\bar{o}FF$	None	
Set point 0	$SP - 0$	SP lower limit to upper limit		0	EU	
Set point 1	$SP - 1$	SP lower limit to upper limit		0	EU	
Set point 2	$SP - 2$	SP lower limit to upper limit		0	EU	
Set point 3	$SP - 3$	SP lower limit to upper limit		0	EU	
Temperature input shift	$\bar{c}nS$	-199.9 to 999.9		0.0	°C or °F	
Upper-limit temperature input shift value	$\bar{c}nSH$	-199.9 to 999.9		0.0	°C or °F	
Lower-limit temperature input shift value	$\bar{c}nSL$	-199.9 to 999.9		0.0	°C or °F	
Proportional band	P	0.1 to 999.9		8.0	EU	
Integral time	\bar{c}	0 to 3999		233	Second	
Derivative time	d	0 to 3999		40	Second	
Cooling coefficient	$\bar{c} - SC$	0.01 to 99.99		1.00	None	
Dead band	$\bar{c} - db$	-199.9 to 999.9		0.1	EU	
Manual reset value	$\bar{o}F - r$	0.0 to 100.0		50.0	%	
Hysteresis (OUT1)	HYS	0.1 to 999.9		1.0	EU	
Hysteresis (OUT2)	$\bar{c}HYS$	0.1 to 999.9		1.0	EU	

Initial setting level

Parameter Name	Symbol	Setting (monitor) Value	Display	Default	Unit	Setting Value
Input type *	ζ n - t	Platinum resistance thermometer 0 : Pt100 1 : Pt100 2 : Pt100 3 : JPt100 4 : JPt100		0	None	
		Thermocouple 0 : K 1 : K 2 : J 3 : J 4 : T 17 : T 5 : E 6 : L 7 : U 18 : U 8 : N 9 : R 10 : S 11 : B		0	None	
		Non-contact temperature sensor 12 : 10 to 70°C 13 : 60 to 120°C 14 : 115 to 165°C 15 : 160 to 260°C				
		Analog input 16 : 0 to 50mA				
Scaling upper limit	ζ n - H	Scaling lower limit +1 to 9999		100	None	
Scaling lower limit	ζ n - L	-1999 to scaling upper limit -1		0	None	
Decimal point	dP	0.1		0	None	
Temperature unit	d-U	°C, °F	ζ , F	°C	None	
Set point upper limit	SL - H	SP lower limit +1 to input range lower value (temperature)		1300	EU	
		SP lower limit +1 to scaling upper limit (analog)		1300	EU	
Set point lower limit	SL - L	Input range lower limit to SP upper limit -1 (temperature)		-200	EU	
		Scaling lower limit to SP upper limit -1 (analog)		-200	EU	
PID - ON/OFF	ζ n t L	2-PID, ON/OFF	Pζ d, onōF	ON/OFF	None	
Standard/Heating and cooling	S-Hζ	Standard, Heating and cooling	Sζ nd, H-ζ	Standard	None	
ST	Sζ	ON, OFF	on, off	ON	None	
Control period (OUT1)	ζ P	1 to 99		20	Second	
Control period (OUT2)	ζ - ζ P	1 to 99		20	Second	
Direct/reverse operation	ō r ζ u	Direct operation, reverse operation	ō r - d, ō r - r	Reverse operation	None	
Alarm 1 type	R L t i	0: Alarm function OFF 1: Upper- and lower-limit alarm 2: Upper-limit alarm 3: Lower-limit alarm 4: Upper- and lower-limit range 5: Upper- and lower-limit alarm with standby sequence 6: Upper-limit alarm with standby sequence 7: Lower-limit alarm with standby sequence 8: Absolute-value upper-limit alarm 9: Absolute-value lower-limit alarm 10: Absolute-value upper-limit alarm with standby sequence 11: Absolute-value lower-limit alarm with standby sequence		2	None	
Move to advanced function setting level	Rñōu	-1999 to 9999		0	None	

Advanced function setting level

Parameter Name	Symbol	Setting (monitor) Value	Display	Default	Unit	Setting Value
Parameter initialize	$\bar{L}n\bar{L}t$	ON, OFF	\bar{on}, \bar{off}	OFF	None	
Multi-SP uses	$\bar{n}SPU$	ON, OFF	\bar{on}, \bar{off}	OFF	None	
SP ramp set value	$SPrt$	OFF, 1 to 9999	$\bar{off}, 1 \text{ to } 9999$	OFF	EU	
Standby sequence reset method	$rESt$	Condition A, Condition B	A, b	Condition A	None	
Alarm 1 open in alarm	$ALIn$	Open in alarm/Close in alarm	$n\bar{o}, n\bar{c}$	Close in alarm	None	
Alarm 1 hysteresis	$ALHI$	0.1 to 999.9		0.2	EU	
ST stable range	$St-b$	0.1 to 999.9		15.0	°C or °F	
α	$ALFA$	0.00 to 1.00		0.65	None	
MV upper limit	$\bar{o}L-H$	MV lower limit +0.1 to 105.0 (standard)		105.0	%	
		0.0 to 105.0 (heating and cooling)		105.0	%	
MV lower limit	$\bar{o}L-L$	-5.0 to MV upper limit -0.1 (standard)		-5.0	%	
		-105.0 to 0.0 (heating and cooling)		-105.0	%	
Input digital filter	$\bar{L}nF$	0.1 to 999.9		0.0	Second	
Additional PV display	$PURd$	ON, OFF	\bar{on}, \bar{off}	OFF	None	
Manipulated variable display	$\bar{o}-dP$	ON, OFF	\bar{on}, \bar{off}	OFF	None	
Automatic return of display mode	rEt	OFF, 1 to 9999	$\bar{off}, 1 \text{ to } 9999$	OFF	Second	
Alarm 1 latch	$ALLt$	ON, OFF	\bar{on}, \bar{off}	OFF	None	
Protect level move time	$PrLt$	1 to 30		3	Second	
Output input error	$SEr\bar{o}$	ON, OFF	\bar{on}, \bar{off}	OFF	None	
Cold junction compensation method	$\bar{L}J\bar{L}$	ON, OFF	\bar{on}, \bar{off}	ON	None	
MB command logic switching	$rLru$	ON, OFF	\bar{on}, \bar{off}	OFF	None	
Move to calibration level	$\bar{L}\bar{n}\bar{o}w$	-1999 to 9999		0	None	

Protect level

Parameter Name	Symbol	Setting (monitor) Value	Display	Default	Unit	Setting Value
Operation/adjustment protection	ᄁᄁᄁᄁ	0 to 3		0	None	
Initial setting/communications protection	ᄁᄁᄁᄁ	0 to 2		1	None	
Setup change protection	ᄁᄁᄁᄁ	ON, OFF	ᄁᄁ, ᄁᄁᄁᄁ	OFF	None	

Communications setting level

Parameter Name	Symbol	Setting (monitor) Value	Display	Default	Unit	Setting Value
Communication unit No.	ᄁ-ᄁᄁ	0 to 99		1	None	
Baud rate	ᄁᄁᄁ	1.2, 2.4, 4.8, 9.6, 19.2	1.2, 2.4, 4.8, 9.6, 19.2	9.6	kbps	
Data bit	ᄁᄁᄁ	7, 8		7	bit	
Stop bit	ᄁᄁᄁᄁ	1, 2		2	bit	
Parity	ᄁᄁᄁᄁ	None, Even, Odd	ᄁᄁᄁᄁ, ᄁᄁᄁᄁ ᄁᄁᄁᄁ	Even	None	

SENSOR INPUT SETTING, INDICATION AND CONTROL RANGES

	Input type	Specifications	Set Value	Input Temperature Range	Input Indication Range
Platinum resistance thermometer input type	Platinum resistance thermometer	Pt100	0	-200 to 850 (°C) / -300 to 1500 (°F)	-220 to 870 (°C) / -340 to 1540 (°F)
			1	-199.9 to 500.0 (°C) / -199.9 to 900.0 (°F)	-199.9 to 520 (°C) / -199.9 to 940 (°F)
			2	0.0 to 100.0 (°C) / 0.0 to 210.0 (°F)	-20 to 120 (°C) / -40 to 250 (°F)
		JPt100	3	-199.9 to 500.0 (°C) / -199.9 to 900.0 (°F)	-199.9 to 520 (°C) / -199.9 to 940 (°F)
			4	0.0 to 100.0 (°C) / 0.0 to 210.0 (°F)	-20 to 120 (°C) / -40 to 250 (°F)

	Input type	Specifications	Set Value	Input Temperature Range	Input Indication Range	
Thermocouple input type	Thermocouple	K	0	-200 to 1300 (°C) / -300 to 2300 (°F)	-220 to 1320 (°C) / -340 to 2340 (°F)	
			1	-20.0 to 500.0 (°C) / 0.0 to 900.0 (°F)	-40 to 520 (°C) / -40 to 940 (°F)	
		J	2	-100 to 850 (°C) / -100 to 1500 (°F)	-120 to 870 (°C) / -140 to 1540 (°F)	
			3	-20.0 to 400.0 (°C) / 0.0 to 750.0 (°F)	-40 to 420 (°C) / -40 to 790 (°F)	
		T	4	-200 to 400 (°C) / -300 to 700 (°F)	-220 to 420 (°C) / -340 to 740 (°F)	
			17	-199.9 to 400.0 (°C) / -199.9 to 700.0 (°F)	-199.9 to 420.0 (°C) / -199.9 to 740.0 (°F)	
		E	5	0 to 600 (°C) / 0 to 1100 (°F)	-20 to 620 (°C) / -40 to 1140 (°F)	
		L	6	-100 to 850 (°C) / -100 to 1500 (°F)	-120 to 870 (°C) / -140 to 1540 (°F)	
		U	7	-200 to 400 (°C) / -300 to 700 (°F)	-220 to 420 (°C) / -340 to 740 (°F)	
			18	-199.9 to 400.0 (°C) / -199.9 to 700.0 (°F)	-199.9 to 420.0 (°C) / -199.9 to 740.0 (°F)	
		N	8	-200 to 1300 (°C) / -300 to 2300 (°F)	-220 to 1320 (°C) / -340 to 2340 (°F)	
		R	9	0 to 1700 (°C) / 0 to 3000 (°F)	-20 to 1720 (°C) / -40 to 3040 (°F)	
		S	10	0 to 1700 (°C) / 0 to 3000 (°F)	-20 to 1720 (°C) / -40 to 3040 (°F)	
		B	11	100 to 1800 (°C) / 300 to 3200 (°F)	0 to 1820 (°C) / 0 to 3240 (°F)	
		Non-contact temperature sensor ES1A	K10 to 70°C	12	0 to 90 (°C) / 0 to 190 (°F)	-20 to 130 (°C) / -40 to 270 (°F)
				13	0 to 120 (°C) / 0 to 240 (°F)	-20 to 160 (°C) / -40 to 320 (°F)
14	0 to 165 (°C) / 0 to 320 (°F)			-20 to 205 (°C) / -40 to 400 (°F)		
15	0 to 260 (°C) / 0 to 500 (°F)			-20 to 300 (°C) / -40 to 580 (°F)		
Analog input	0 to 50mV	16	One of following ranges depending on the results of scaling: -1999 to 9999, -199.9 to 999.9	-5 to 105% of the setting range (However, -1999 to 9999 or -199.9 to 999.9 is displayed)		

- “0” is the default for both input types.
- The applicable standards for each of the above input ranges are as follows:
 K, J, T, E, N, R, S, B : JIS C1602-1995, IEC 584-1
 L : Fe-CuNi, DIN 43710-1985
 U : Cu-CuNi, DIN 43710-1985
 JPt100 : JIS C 1604-1989, JIS C 1606-1989
 Pt100 : JIS C 1604-1997 IEC 751

Control Range

- Platinum resistance thermometer and thermocouple input
 –20°C of temperature setting lower limit to +20°C of the temperature setting upper limit
 Or,
 –40°F of temperature setting lower limit to +40°F of the temperature setting upper limit
- ES1A input
 Same as input indication range
- Analog input
 –5% to +105% of scaling range

SETUP LEVELS DIAGRAM

The following diagram shows an overview of the setup levels on the E5GN. To move to the advanced function setting level and calibration level, you must enter passwords. Some parameters are not displayed depending on the protect level setting and the conditions of use.

Control stops when you move from the operation level to the initial setting level.

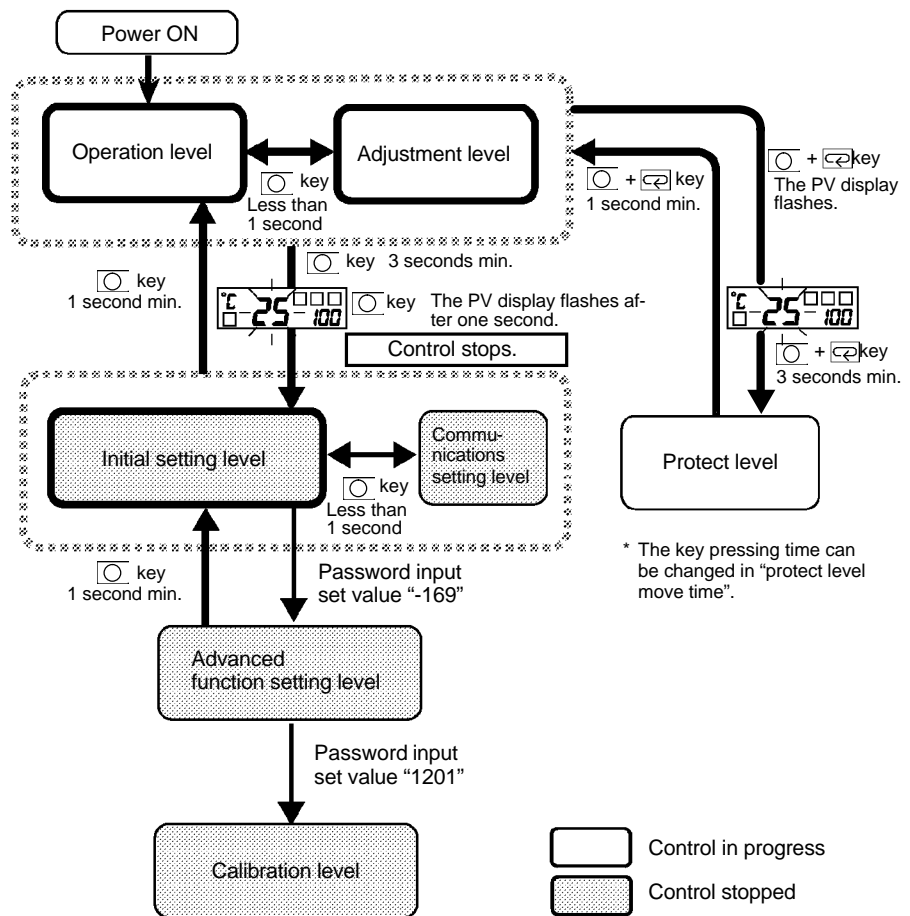





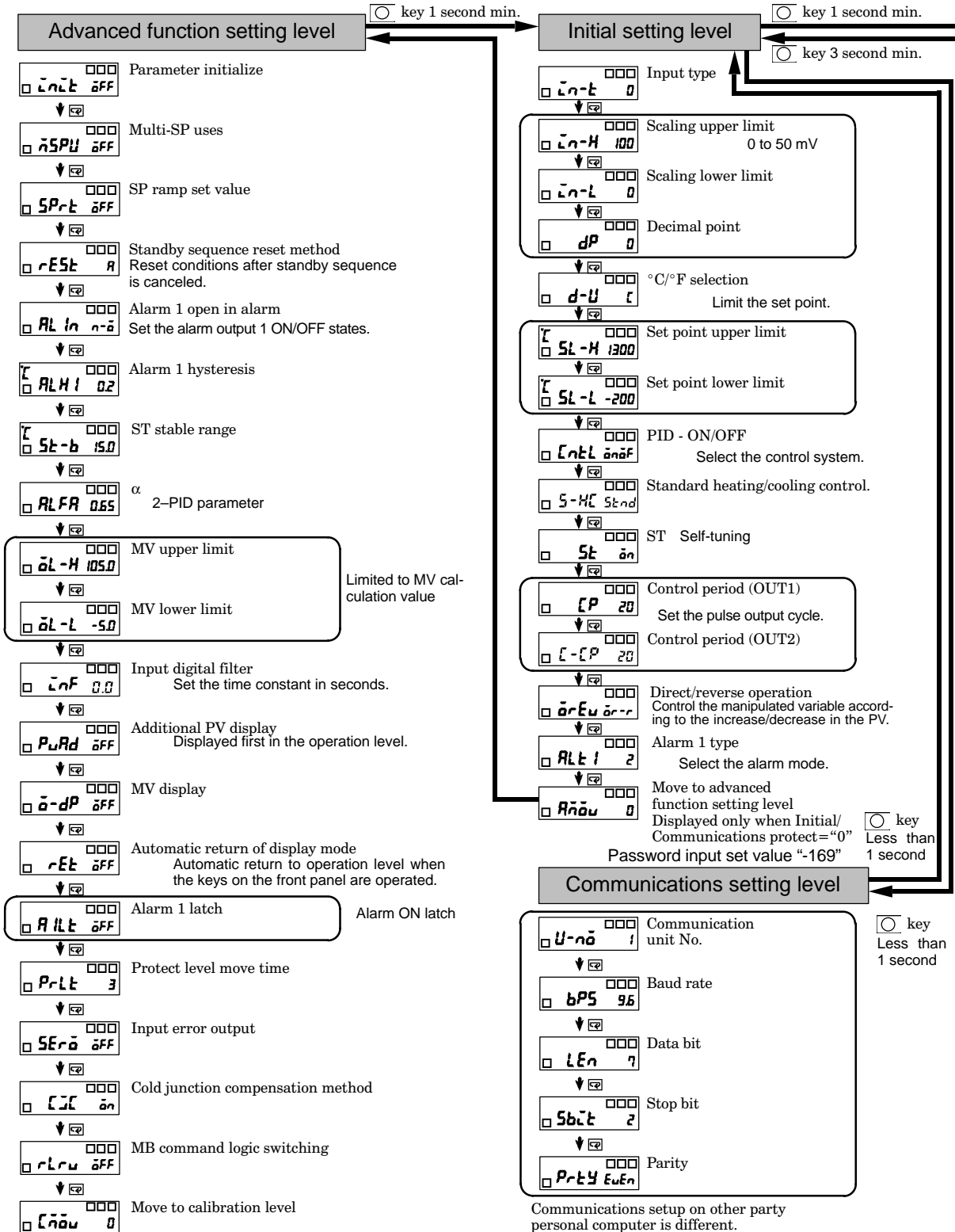

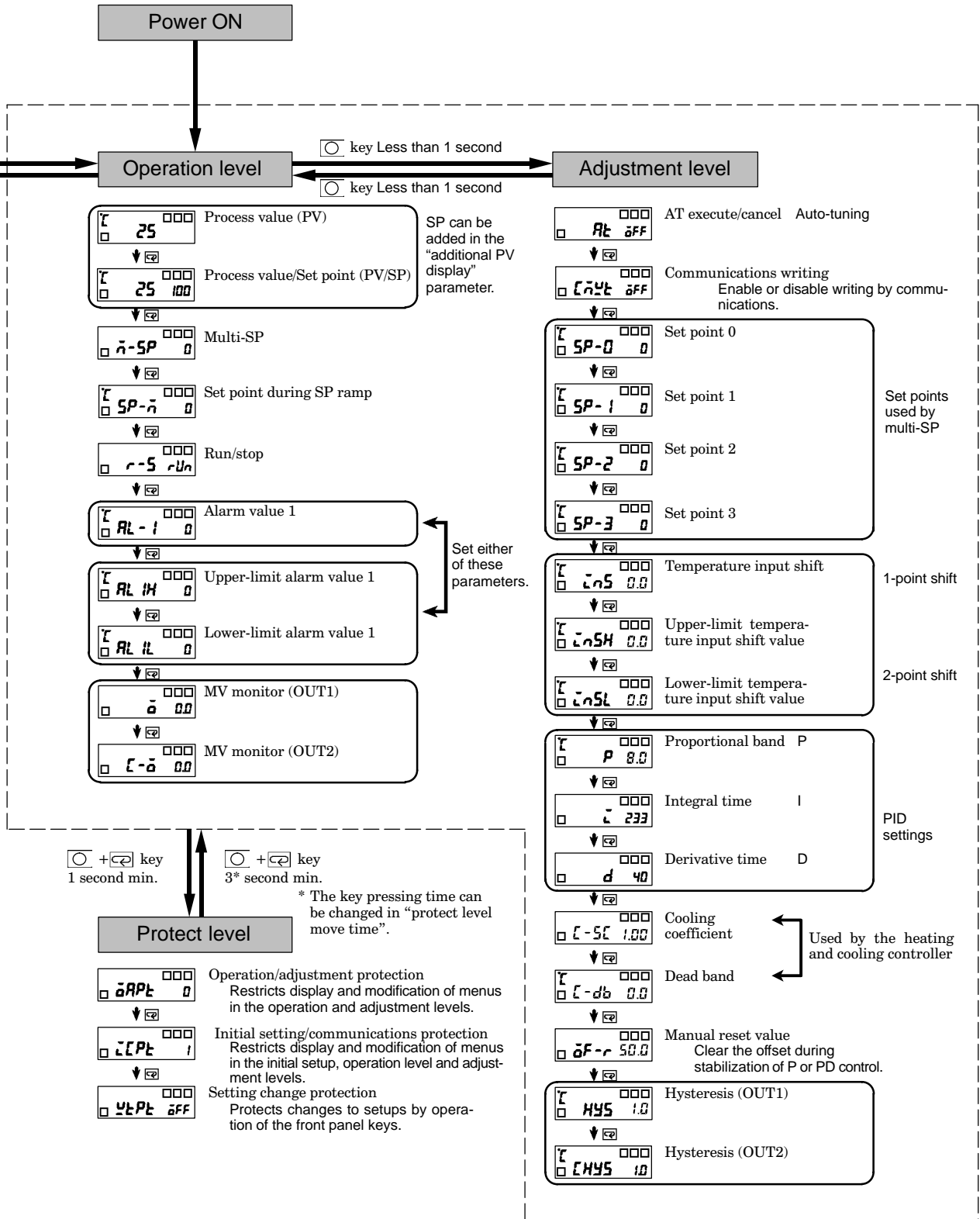
PARAMETER FLOW

- If you press the mode key at the last parameter in each level, you return to the top parameter in that level.





 (down) key	1-3
 (level) key	1-3
 +  key combination	1-3
 (mode) key	1-3
 (up) key	1-3

Numbers

1-point shift	4-2
1-point shift method	4-4
2-PID control	3-6
2-point shift	4-3
2-point shift method	4-4
3-position control	3-10

A

a	5-30
Additional PV display	5-32
Adjustment level	1-7, 5-10
Advanced function setting level	1-7, 5-25, 6-2, A-8
Alarm 1 hysteresis	5-29
Alarm 1 open in alarm	5-29
Alarm 1 type	5-7, 5-23, 5-28
Alarm hysteresis	4-6
Alarm latch	4-6
Alarm output	3-17
Alarm type	3-18
Alarm value	3-19, 5-7, 5-28
Alarm value 1	5-7
Analog input	1-5, 3-4, 4-8, 6-3, 6-10
AT (auto-tuning)	3-12
AT execute/cancel	3-12, 5-11
Automatic return of display mode	5-33

C

Calibrating analog input	6-7
Calibrating input	6-3
Calibrating platinum resistance thermometers	6-8
Calibrating thermocouples	6-4
Calibration level	1-8
Changing the SP	3-9
Characteristics	A-3
Checking indication accuracy	6-9
Close in alarm/open in alarm	4-7
Communications	2-6
Communications data length	5-37
Communications function	1-5, 1-9
Communications parity	5-37
Communications setting level	5-36, A-9
Communications setup level	1-7
Communications stop bit	5-37
Communications unit No.	5-37

Connecting the cold junction compensator	6-4
Control adjustment	1-5
Control output	1-5
Control period	3-7
Cooling coefficient	4-9, 4-10, 5-15

D

Dead band	4-9, 4-10, 5-15
Decimal point	5-7, 5-19, 5-27
Derivative time	3-12, 5-14
Description	3-12
Determining PID constants (AT, ST, manual setup)	3-12
Dimensions	2-2
Direct/reverse operation	3-7, 5-23
Display	1-2

E

Error display	A-4
Example of 2-point temperature input shift	4-5
Executing ON/OFF control	3-10
Executing the SP ramp function (limiting the SP change rate)	4-15

F

Fixing settings	1-8
Front panel	1-2

H

Heating and cooling control	4-9
How setup levels are configured and operating the keys on the front panel	1-6
How to calculate input shift values (2-point shift)	4-3
How to use keys	1-3
Hysteresis	3-10
Hysteresis (cool)	5-16
Hysteresis (heat)	5-16

I

I/O configuration	1-4
Initial setting level	1-7, 5-17, A-7
Initial setting/communications protection	4-18
Initial setup examples	3-2
Input digital filter	5-32
Input error	A-4
Input sensor types	1-5
Input type	3-4, 5-7, 5-18, 5-27, A-10
Installation	2-2
Integral time	3-12, 5-14

K

Key protect	4-18
-------------	------

L

Lower-limit temperature input
shift value 5-13

M

Manipulated variable display 5-33

Manual reset value 5-16

Manual setup 3-15

MB command logic switching 5-36

Memory error A-4

Mounting 2-3

Multi-SP (set point 0 to 3) 5-5

MV lower limit 5-31

MV monitor (cool) 5-9

MV monitor (OUT1) 5-8

MV upper limit 5-31

N

Names of parts 1-2

No.1 display 1-2

No.2 display 1-2

O

ON/OFF control 3-6, 3-10, 3-11

Operate the keys on the front panel 3-4

Operating the keys
on the front panel 1-8, 4-18

Operation at start 4-16

Operation indicators 1-2

Operation
level 1-7, 3-11, 5-4, 5-10, 5-17, 5-33, A-6

Operation/adjustment protection 4-18

P

Panel cutout 2-2

Parameter flow A-13

Parameter initialize 5-26

Parameter operations list A-6

Parameter structure 6-2

PID / ON/OFF 5-21

PID constants 3-15

Power supply 2-4

Precautions when wiring 2-4

Preparations 6-4

Proportional band 3-12, 5-14

Proportional operation 3-15

Protect level 1-7, 5-3, A-9

PV/SP 3-9, 5-5, 5-6, 5-33

R

Ratings A-2

Registering calibration data 6-3

Restart 4-6

Restrictions during SP ramp operation . 4-16

RS-485 2-6

Run/Stop 5-7

S

Scaling lower limit 5-7, 5-19, 5-27

Scaling upper limit 5-7, 5-19, 5-27

Selecting _C/_F 3-5

Selecting parameters 1-8

Selecting PID control or
ON/OFF control 3-6

Sensor input setting,
indication and control ranges A-10

Set point 0 4-11, 5-12

Set point 1 4-11, 5-12

Set point 2 4-11, 5-12

Set point 3 4-11, 5-12

Set point during SP ramp 4-15, 5-6

Set point limiter 4-13

Set point lower limit 5-6

Set point upper limit 5-6

Setting change protection 4-18

Setting heating and cooling control 4-10

Setting multi-SP 4-11

Setting output specifications 3-7

Setting scaling upper and lower limits
(analog input) 4-8

Setting the input type 3-4

Setting the PID / ON/OFF parameter .. 3-11

Setting the SP 3-9

Setting the SP by key operation 4-11

Setting the SP upper and
lower limit values 4-13

Setting up communications data 1-9

Setup levels diagram A-12

Shifting input values 4-2

SP ramp 4-15, 4-16

SP ramp set value 5-27

Specifications A-2

ST (self-tuning) 3-13

ST self-tuning 5-22

ST stable range 3-14, 5-30

ST start conditions 3-14

Standby sequence 4-6, 5-28

Standby sequence reset method 5-28

Summary of alarm operations 4-7

T

Temperature
input 1-5, 4-8, 5-7, 5-20, 5-27

Temperature input shift 5-13

Temperature unit 1-2, 3-5

Terminal arrangement 2-4

U

Upper-limit temperature
input shift value 5-13

User calibration 6-3

Using the key protection level 4-18

W

Wiring 2-4

Revision History

A manual revision code appears as a suffix to the catalog number on the front cover of the manual.

Cat. No. H101-E1-03A

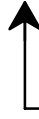

Revision code

The following table outlines the changes made to the manual during each revision. Page numbers refer to previous version.

Revision code	Data	Revised content
1	October 1998	Original production
2	January 2000	<p>All Pages: Modified the level key mark.</p> <p>Page V: Changed "Meanings of Abbreviations".</p> <p>Page 1-4: Modified the diagram in "I/O configuration".</p> <p>Page 1-6: Modified the diagram in "How Setup Levels Are Configured and Operating the Key on the Front Panel".</p> <p>Page 2-2: Modified the diagram in "Panel cutout".</p> <p>Page 2-7: Added "2.3 Requests at Installation".</p> <p>Page 3-4: Modified the table in "List of Input Types".</p> <p>Page 3-11: Added "Setting the SP".</p> <p>Page 3-14: Modified "ST start conditions".</p> <p>Page 3-17: Modified "Alarm type".</p> <p>Page 3-20: Added "3.10 Requests during Operation".</p> <p>Page 4-6: Added "Alarm latch".</p> <p>Page 4-9 to 10: Added new pages.</p> <p>Page 5-3: Modified the diagram in "Protect Level".</p> <p>Page 5-4: Modified the diagram in "Operation level".</p> <p>Page 5-9: Added "MV monitor (OUT2)".</p> <p>Page 5-10: Modified the diagram in "Adjustment level".</p> <p>Page 5-17: Modified the diagram in "Initial setting level".</p> <p>Page 5-18: Modified the table in "Input type".</p> <p>Page 5-21: Added "Standard/heating and cooling".</p> <p>Page 5-22: Changed the default in "ST self-tuning".</p> <p>Page 5-23: Modified "Alarm 1 type1".</p> <p>Page 5-25: Modified the diagram in "Advanced Function Setting Level".</p> <p>Page 5-35 to 37: Added new pages.</p> <p>Page A-2: Modified the table in "Ratings".</p> <p>Page A-3: Modified the table in "Characteristics".</p> <p>Page A-6: Modified the table in "Operation level" and "Adjustment level".</p> <p>Page A-7: Modified the table in "Initial setting level".</p> <p>Page A-8: Modified the table in "Advanced function setting level".</p> <p>Page A-9: Modified the table in "SENSOR INPUT SETTING AND INDICATION RANGES".</p> <p>Page A-9: Added "Control range".</p> <p>Page A-10: Modified the diagram in "SETUP LEVELS DIAGRAM".</p> <p>Page A-11 to 12: Modified the diagram in "PARAMETER FLOW".</p>

Revision code	Data	Revised content
3	July 2000	<p>Page V: Added "Meanings of Abbreviations".</p> <p>Page VI: Added "Appendix".</p> <p>Page 1–2: Modified "Display" description.</p> <p>Page 1–5: Modified "Main functions" description.</p> <p>Page 1–7: Modified "Advanced function setting level".</p> <p>Page 2–3: Modified "Mounting".</p> <p>Page 2–5: Modified illustration and "Alarm output 1/control output 2".</p> <p>Page 2–6: Modified illustration.</p> <p>Page 3–2: Modified "Initial setting level" part.</p> <p>Page 3–4: Added "Set value 17 and 18".</p> <p>Page 3–8: Modified "Temperature unit" and "Direct/reverse operation".</p> <p>Page 3–10: Modified illustration</p> <p>Page 3–11: Modified table in "Parameters".</p> <p>Page 3–18: Modified "**4".</p> <p>Page 4–8: Modified illustration.</p> <p>Page 4–9: Modified "Dead band".</p> <p>Page 4–11: Modified (1) in "Setup".</p> <p>Page 5–4: Added description text.</p> <p>Page 5–5: Modified table and text in "PV" and "PV/SP".</p> <p>Page 5–7: Modified "Alarm value 1".</p> <p>Page 5–8: Modified "Upper-limit alarm value 1" and "MV monitor (out 1)".</p> <p>Page 5–18: Added "Set value 17 and 18".</p> <p>Page 5–31: Added "Heating and cooling".</p> <p>Page 5–34: Modified "Alarm 1 latch".</p> <p>Page 6–4: Added 17.18 to "Input types".</p> <p>Page 6–6: Added 17.18 to "Input types" and modified (14).</p> <p>Page A–2: Modified "Relay output" in the table.</p> <p>Page A–4: Added "Analog input" to "Meaning".</p> <p>Page A–5: Added diagram.</p> <p>Page A–6: Added "Cooling coefficient" and "Dead band" to "Adjustment level".</p> <p>Page A–8: Modified table in "Advanced function setting level".</p> <p>Page A–10: Added "Input indication range" to table. Added 17.18 to "Input types".</p>
	March 2002	<p>Page 2–2: Modified the diagram in "Panel cutout".</p> <p>Page A–7: Modified the table in "Initial setting level".</p> <p>Page A–12 to 13: Modified the diagram in "PARAMETER FLOW".</p>
03A	March 2005	<p>Page A–3: Added information to table and accompanying notes.</p>

OMRON

OMRON Corporation
Industrial Automation Company

Industrial Devices and Components Division H.Q.
Measuring Components Department

Shiokoji Horikawa, Shimogyo-ku,
Kyoto, 600-8530 Japan
Tel: (81)75-344-7080/Fax: (81)75-344-7189

Regional Headquarters

OMRON EUROPE B.V.

Wegalaan 67-69, NL-2132 JD Hoofddorp
The Netherlands
Tel: (31)2356-81-300/Fax: (31)2356-81-388

OMRON ELECTRONICS LLC

1 East Commerce Drive, Schaumburg, IL 60173
U.S.A.
Tel: (1)847-843-7900/Fax: (1)847-843-8568

OMRON ASIA PACIFIC PTE. LTD.

83 Clemenceau Avenue,
#11-01, UE Square,
239920 Singapore
Tel: (65)6835-3011/Fax: (65)6835-2711

OMRON CHINA CO., LTD. BEIJING OFFICE

Room 1028, Office Building,
Beijing Capital Times Square,
No. 88 West Chang'an Road,
Beijing, 100031 China
Tel: (86)10-8391-3005/Fax: (86)10-8391-3688

Authorized Distributor: