

# MITSUBISHI

FOR IBM-PC/AT COMPUTERS  
MODEL A70BDE-ABF A-BUS CONTROL INTERFACE BOARD

## User's Manual

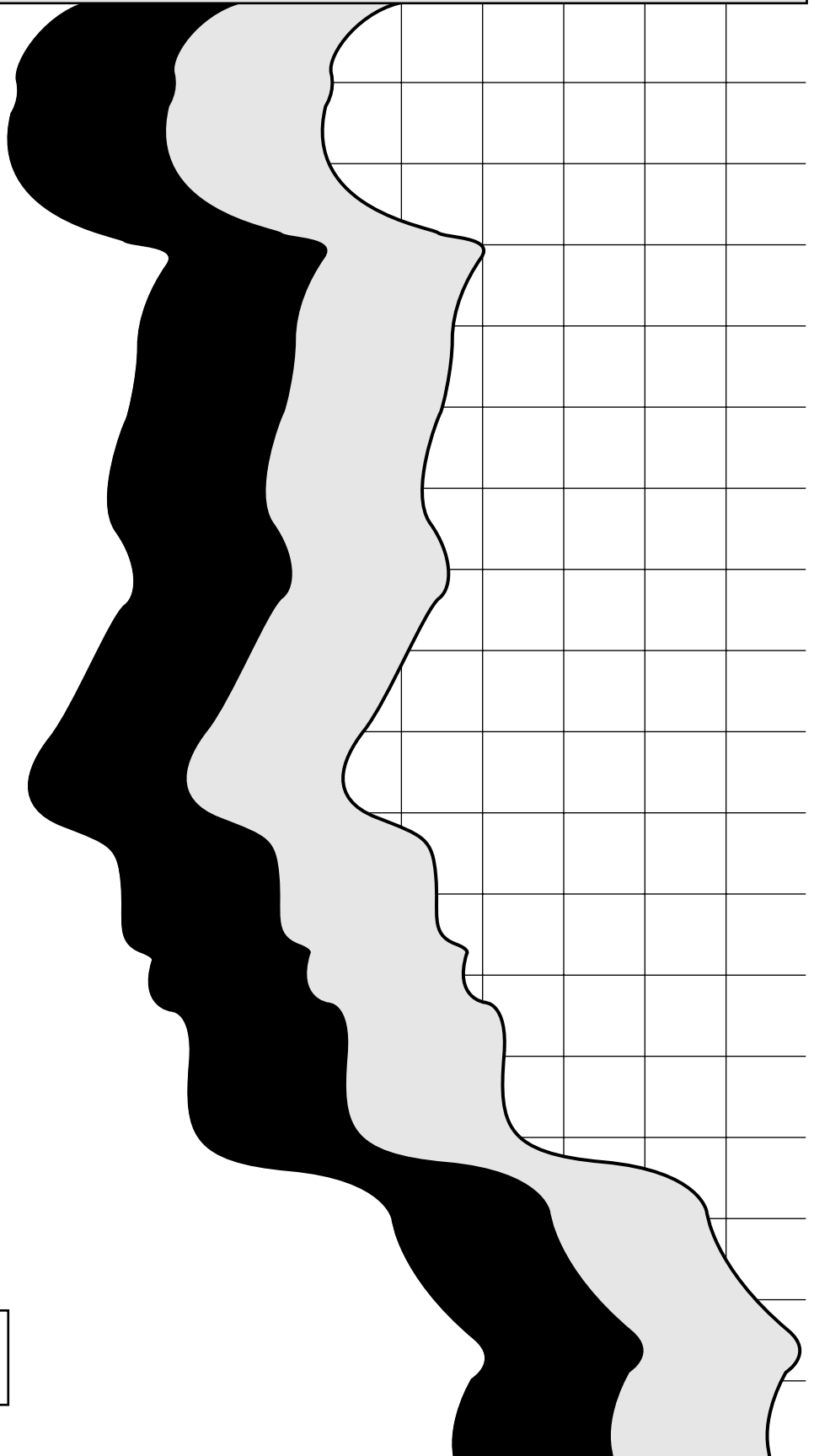

MELSEC

## ● SAFETY PRECAUTIONS ●

(Please be sure to read these precautions before use.)

When using the MELSEC series interface board for general-purpose computers, familiarize yourself with the contents of the manual provided with each product and the related manuals referred to in the manuals provided, and take every care to ensure safety and adhere to correct operating procedures. In this manual, there are two levels of safety precautions: "danger" and "caution."



This is indicated when product mishandling can lead to a dangerous situation in which death or serious injury may result.



This is indicated when product mishandling can lead to a dangerous situation in which moderate damage or minor injury may result or in which only physical damage may occur.

Depending on the circumstances, even a situation in which the user is given warning by the  **Caution** indication can lead to serious consequences. Under whichever heading the cautionary note falls under, the warning given is important and the precautions described must be adhered to.

Ensure that the manual provided with the product is kept in a safe place for future reference and that it is handed over to the end user.



### [Safety Precautions for Design]

- Install a safety circuit outside the sequencer so that the entire system will operate on the side of safety when the IBM-PC/AT computer has failed.

Accidents may be caused by erroneous outputs and incorrect operation.

- (1) Configure all circuits in the following categories outside the sequencer: emergency stop circuits, protection circuits, interlock circuits for forward/reverse rotation and other reciprocal operations, interlock circuits for positioning upper/lower limits and other mechanisms for safeguarding the machine from damage.
- (2) The ABF board or the power supply module on the expansion base detects any of the following trouble statuses, processing is stopped and all outputs are turned off.
  - When the overcurrent protection device or overvoltage protection device in the power supply module has been activated.
  - When the ABF board has detected a watchdog time error or other error using its self-diagnosis function. In the event of trouble in the input/output control area, etc. which cannot be detected by the ABF board, all the outputs may be turned on. Configure a failsafe circuit or provide a mechanism external to the sequencer in order to ensure that the machine will operate safely in a case like this.

For examples of failsafe circuits, refer to the User's Manual of the ABF board.

 **Caution**

**[Safety Precautions for Design]**

- Do not bundle the control and communication cables together with the main circuit lines or power lines, and do not even run them in the vicinity of such.  
As a general guideline, maintain a distance of at least 100 mm (3.94 inch) between them.  
Otherwise, noise may result causing malfunctions.
- The proper power-on sequence is as follows: first turn on the expansion base power, and then turn on the external power for the process.  
Failure to comply with this sequence may result in an incorrect output from the output module.

 **Caution**

**[Safety Precautions for Installation]**

- Use the board in an environment where all the general specifications given in the User's Manual are met.  
Use in an environment which does not comply with the general specifications can cause electric shocks, fire, malfunctioning and damage or deterioration to the product.
- Install the board properly in the ISA-bus slot of the installation module in which the board is to be installed.  
Improper installation of the board can cause malfunctioning and failures or it can cause the board to fall out of the module in which it was installed.
- Connect the expansion cables properly to the connectors on the board. After installation, check whether the cables have lifted free from the connectors.  
Defective contact can cause problems in input and output.
- When handling the board, take care to protect yourself from injury by the mounted components, surrounding parts, etc.
- Before handling the board, discharge any static electricity which may have accumulated in your body.  
Failure to do so can cause failures.
- Do not touch the electronic components on the board directly with your hands.  
This may cause the components to deteriorate.

 **Danger**

**[Safety Precautions for Wiring]**

- Before installing the board, installing or removing the modules on the expansion base units or performing any wiring work, be absolutely sure to shut down at the external sources all the power for all the phases concerned. Failure to do so can cause electric shocks or damage the product.
- After having installed the board and connected the wires, be absolutely sure to attach the cover of the general-purpose IBM-PC/AT computer unit before turning on the power or performing operations. Failure to attach the unit cover may lead to electric shocks.

 **Caution**

**[Safety Precautions for Wiring]**

- Tighten up the screws anchoring the board using the specified torque.  
Looseness of these screws can cause malfunctioning.  
Over-tightening of the screws anchoring the board can result in malfunctioning due to damage to the screws and board.
- Take care to keep chips, scraps of wire and other foreign matter away from the board.  
Failure to do so can cause fire, failures or malfunctioning.

 **Danger**

**[Safety Precautions at Startup and Maintenance]**

- Do not connect or disconnect the expansion cables while the power is still on.  
This can cause malfunctioning.
- Switch off the power before tightening up the screws which anchor the board.  
Failure to switch off the power for all the phases concerned may lead to electric shocks.  
Looseness of the screws anchoring the board can cause malfunctioning.  
Over-tightening of the screws anchoring the board can result in malfunctioning due to damage to the screws and board.

 **Caution**

**[Safety Precautions at Startup and Maintenance]**

- Do not disassemble or remodel the board.  
This can cause failures, malfunctioning, injury or fire.
- Before installing the board or installing or removing the modules on the expansion base units, be absolutely sure to shut down at the external sources all the power for all the phases concerned.  
Failure to do so can cause the board to fail or malfunction.
- Before installing the board, discharge any static electricity which may have accumulated in your body.  
Static electricity can cause failures.

 **Caution**

**[Safety Precautions for Disposal]**

- Dispose of this product as an industrial waste product.

# REVISIONS

\* The manual number is given on the bottom left of the back cover.

Print Date	* Manual Number	Revision
Apr., 1997	IB(NA)-66754-A	First edition
Sep., 1997	IB(NA)-66754-B	<p data-bbox="592 394 692 421"><b>Addition</b></p> <p data-bbox="612 443 770 470">Section 5, 6, 9</p> <p data-bbox="592 479 715 506"><b>Correction</b></p> <p data-bbox="612 528 823 555">Section 2.1.1, 8.1.3</p>

This manual does not imply guarantee or implementation right for industrial ownership or implementation of other rights. Mitsubishi Electric Corporation is not responsible for industrial ownership problems caused by use of the contents of this manual.



# INTRODUCTION

Thank you for purchasing this MELSEC series interface board for general-purpose IBM-PC/AT computers made by Mitsubishi Electric.

Please read through this manual carefully and familiarize yourself with the functions and performance of this interface board so that you will be able to operate it correctly.

## Outline of Contents

### **1 OVERVIEW**

This chapter describes the features of the model A70BDE-ABF A-bus control interface board, and gives details on the parts packed with the board.

### **2 SYSTEM CONFIGURATION**

This chapter describes how the system may be configured when the model A70BDE-ABF A-bus control interface board is installed in the IBM-PC/AT computer and used to control the Input/Output modules and special function module on the expansion base units. It also provides some cautionary notes.

It must be read before designing a system.

### **3 SPECIFICATIONS**

This chapter details the specifications of the model A70BDE-ABF A-bus control interface board.

It must be read before designing a system.

### **4 NAMES OF THE PARTS AND THEIR SETTINGS**

This chapter describes the names of the parts on the model A70BDE-ABF A-bus control interface board and the switch settings available.

It must be read before installing the interface board in an IBM-PC/AT computer.

### **5 POWER SUPPLY MODULES**

This section describes the specifications and handling of the power supply units.

Be sure to read it through before installing a power supply unit in the system.

### **6 BASE UNIT AND EXTENSION CABLES**

This section describes the specifications and handling of the base unit and extension cables.

Be sure to read it through before installing the base unit and extension cables in the system.

### **7 MOUNTING AND INSTALLATION**

This chapter describes the methods used to mount and install the model A70BDE-ABF A-bus control interface board, and it also provides some cautionary notes. It must be read before mounting the system.

### **8 DRIVER INSTALLATION, DELETION**

This chapter outlines the methods used to install and delete the model A70BDE-ABF A-bus control interface board's drivers for Windows NT.

It must be read before installing or deleting a driver.

### **9 UTILITY**

This section describes how to operate the A70BDE-ABF A bus control interface board utility.

### **10 TROUBLESHOOTING**

This chapter gives the troubleshooting flow to be referred to when trouble has occurred on the model A70BDE-ABF A-bus control interface board.

Read it when trouble has occurred on the interface board.

## **Appendix 1 List of Controllable Input/Output Modules and Special Function Modules**

## **Appendix 2 Outline Drawings of A70BDE-ABF**



NOTES
-------

- o Mitsubishi Electric offers no guarantees for any software products sold on the market which are compatible with Windows NT and which are introduced by Mitsubishi Electric.
- o The software copyrights of this product belong to Mitsubishi Electric.
- o It is strictly forbidden to quote or copy this manual by any means either in part or in its entirety without permission from Mitsubishi Electric.
- o Every effort is made to reflect software and hardware revisions in the contents of this manual but sometimes it is impossible to synchronize the printing of the manual with the latest revisions.
- o This product's software programs are designed in such a way that one package is to be purchased per computer in principle.
- o This product (and its manual) can be used only after the user has agreed to the provisions of the License Agreement.
- o Mitsubishi Electric will not be held liable for whatever effects have resulted from the operation of this product (and its manual).
- o The specifications of this product and the contents of this manual are subject to change without notice.

#### Trademarks

Windows NT is the trademark or registered trademark of Microsoft Corporation.  
Other company and product names appearing in the text are the trademarks or registered trademarks of the companies concerned.

<b>IMPORTANT</b>
------------------

- (1) Design the system in such a way that the safety circuit and circuit for protection from sequencer trouble are placed outside the sequencer.
- (2) Mounted on the PCBs of the interface board are electronic components which are susceptible to static. Therefore, observe the following precautions when handling the PCBs.
  - (a) Ground your body and the work bench.
  - (b) Do not directly touch the product's conductive parts or electrical components.



# CONTENTS

<b>1 OVERVIEW</b>	<b>1- 1~1- 2</b>
1.1 Features	1- 1
1.2 Accessories	1- 2
<b>2 SYSTEM CONFIGURATION</b>	<b>2- 1~2- 3</b>
2.1 System Configuration	2- 1
2.1.1 System Configuration when A/AnS Series Module is Used	2- 1
2.2 Checkpoints for System Configuration	2- 2
<b>3 SPECIFICATIONS</b>	<b>3- 1~3- 3</b>
3.1 General Specifications	3- 1
3.2 Performance Specifications	3- 3
<b>4 NAMES OF THE PARTS AND THEIR SETTINGS</b>	<b>4- 1~4- 9</b>
4.1 Handling Precautions	4- 1
4.2 Names of Parts	4- 2
4.3 Parts Settings	4- 3
4.3.1 Input/Output Address Setting	4- 3
4.3.2 Memory Address Setting	4- 4
4.3.3 Interrupt Signal Setting	4- 5
4.3.4 User-Specified Setting	4- 6
4.3.5 Statuses of LED Displays	4- 8
<b>5 POWER SUPPLY MODULES</b>	<b>5- 1~5- 14</b>
5.1 Specifications	5- 1
5.1.1 Power Supply Module Specifications	5- 1
5.1.2 Selection Criterion of Power Supply Modules	5- 4
5.1.3 Fuse Specifications	5- 6
5.2 Handling	5- 7
5.2.1 Handling Precautions	5- 7
5.2.2 Names of parts	5- 8
5.2.3 Settings	5-14
<b>6 BASE UNIT AND EXTENSION CABLES</b>	<b>6- 1~6- 5</b>
6.1 Specifications	6- 1
6.1.1 Specifications Table for Standard Type of Extension Base Unit	6- 1
6.1.2 Specifications Table for Standard Type of Extension Cables	6- 1
6.1.3 Specifications Table for Compact Type of Extension Base Unit	6- 2
6.1.4 Specifications Table for Compact Type of Extension Cables	6- 2
6.2 Handling Precautions	6- 2

6.3	Names of Parts	6- 3
6.4	Setting the Extension Stage Number	6- 5

<b>7 MOUNTING AND INSTALLATION</b>	<b>7- 1~7- 18</b>
------------------------------------	-------------------

7.1	Failsafe Measure for Proper Operation when the Power is Turned ON	7- 1
7.2	Failsafe Measure for Output Module Failures	7- 2
7.3	Installation Environment	7- 4
7.4	Expansion Base Unit Installation	7- 5
7.4.1	Cautionary Notes on Installation	7- 5
7.4.2	Installation Positions of Expansion Base Unit	7- 6
7.5	Module Installation and Removal	7- 7
7.6	Wiring	7-11
7.6.1	Wiring Precautions	7-12
7.7	Wiring Connections to Module Terminals	7-16
7.8	Error Output Terminal Connection Method	7-17
7.9	Precautions for Connection with Uninterruptible Power System	7-18

<b>8 DRIVER INSTALLATION, DELETION</b>	<b>8- 1~8- 3</b>
--	------------------

8.1	Installation/Deletion of Windows NT Driver	8- 1
8.1.1	Installation of Windows NT Driver	8- 1
8.1.2	Directories Configuration After Installation	8- 2
8.1.3	Deletion of Windows NT Driver	8- 2
8.1.4	Windows NT Driver Status Change Procedure	8- 3

<b>9 UTILITY</b>	<b>9- 1~9- 17</b>
------------------	-------------------

9.1	Start Method	9- 1
9.2	Table of Functions	9- 2
9.3	Description of Buttons	9- 3
9.4	INFORMATION Screen Operations	9- 4
9.5	DEVICE MONITOR Screen Operations	9- 6
9.5.1	Initial Screen	9- 6
9.5.2	Bit Device Screen	9- 7
9.5.3	Buffer Memory Screen	9- 9
9.6	I/O LOCATION Screen Operations	9-11
9.7	TEST Screen Operations	9-13
9.7.1	Board Test	9-14
9.7.2	WDT Test	9-16
9.8	VERSION Information	9-17

**10 TROUBLESHOOTING****10- 1~10- 12**

10.1 Troubleshooting Tips .....	10-1
10.2 Troubleshooting Flow .....	10-2
10.3 Flow in Cases where Windows NT Fails to Start Up .....	10-3
10.4 Flow in Cases where Error Messages Appear on Event Viewer .....	10-4
10.5 Flow in Cases where No Signals are Output from Error Output Terminals .....	10-5
10.6 Flow in Cases where the Error is Checked from the Status of the ABF, OS, ERR and WDT ERR LEDs .....	10-6
10.6.1 Flow in Cases where System Startup Error has Occurred .....	10-7
10.6.2 Flow in Cases where System WDT Error has Occurred .....	10-8
10.6.3 Flow in Cases where User WDT Error has Occurred .....	10-9
10.6.4 Flow in Cases where Internal Temperature Rise Error or AC Cut-off Detection Error has Occurred .....	10-10
10.6.5 Flow in Cases where A-bus Reset Error Processing, A-bus Trouble Error Processing or Gate Array Self-diagnosis Error has Occurred .....	10-11
10.7 Flow in Cases where ABF Utility Error has Occurred .....	10-12

**APPENDIX****APP- 1 ~ APP- 10**

Appendix 1 List of Controllable Input/Output Modules and Special Function Modules .....	App- 1
Appendix 2 Outline Drawings of A70BDE-ABF .....	App- 10

## 1 OVERVIEW

This manual describes the specifications and handling procedures of the model A70BDE-ABF A-bus control interface board (hereafter abbreviated to "ABF board") which is designed to be installed in an IBM-PC/AT computer (only Windows NT Workstation 4.0 (see \*1) is supported as the operating system) and used to control the Input/Output modules and special function modules on the expansion bases.

### 1.1 Features

The ABF board has the following features.

- (1) The ABF board can control sequencer Input/Output modules and special function modules in the A series and AnS series directly. It can be installed in an IBM-PC/AT computer and used to control the Input/Output modules and special function modules on the expansion base units by means of expansion cables.  
(Maximum number of Input/Output points: 3,584 points when A series is used, 1,536 points when AnS series is used)
- (2) The ABF board comes with error detection functions for improved reliability. WDT, internal temperature detection and AC cut-off count detection are among the ABF board's error detection functions which are not provided by general-purpose computers.
- (3) The ABF board offers an open environment.  
An open environment is provided for sequencer users by using the I/O drivers made by a SoftLogic (see \*2) manufacturer.
- (4) This option board supports ISA buses.  
Since this half-size option board supports ISA busses, it can be installed in any IBM-PC/AT computer.

(\*1) Windows NT Workstation 4.0 is hereafter abbreviated to Windows NT.

(\*2) "SoftLogic" is a software program for achieving the development environment, execution environment, monitoring, etc. in a sequencer-like format in order to control the Input/Output modules and special function modules on the general-purpose computer.

## 1.2 Accessories

After opening the box in which the product was packed, check that all the parts listed in the table below are present and accounted for in the box.

Name of part	Quantity
Model A70BDE-ABF A-bus control interface board	1
Model S10INF-ABF-E software package	1
User's manual for model A70BDE-ABF A-bus control interface board installed in IBM-PC/AT computer	1



## 2 SYSTEM CONFIGURATION

### 2.1 System Configuration

Shown below is the system configuration when the ABF board is installed in an IBM-PC/AT computer for operation.

#### 2.1.1 System Configuration when A/Ans Series Module is Used

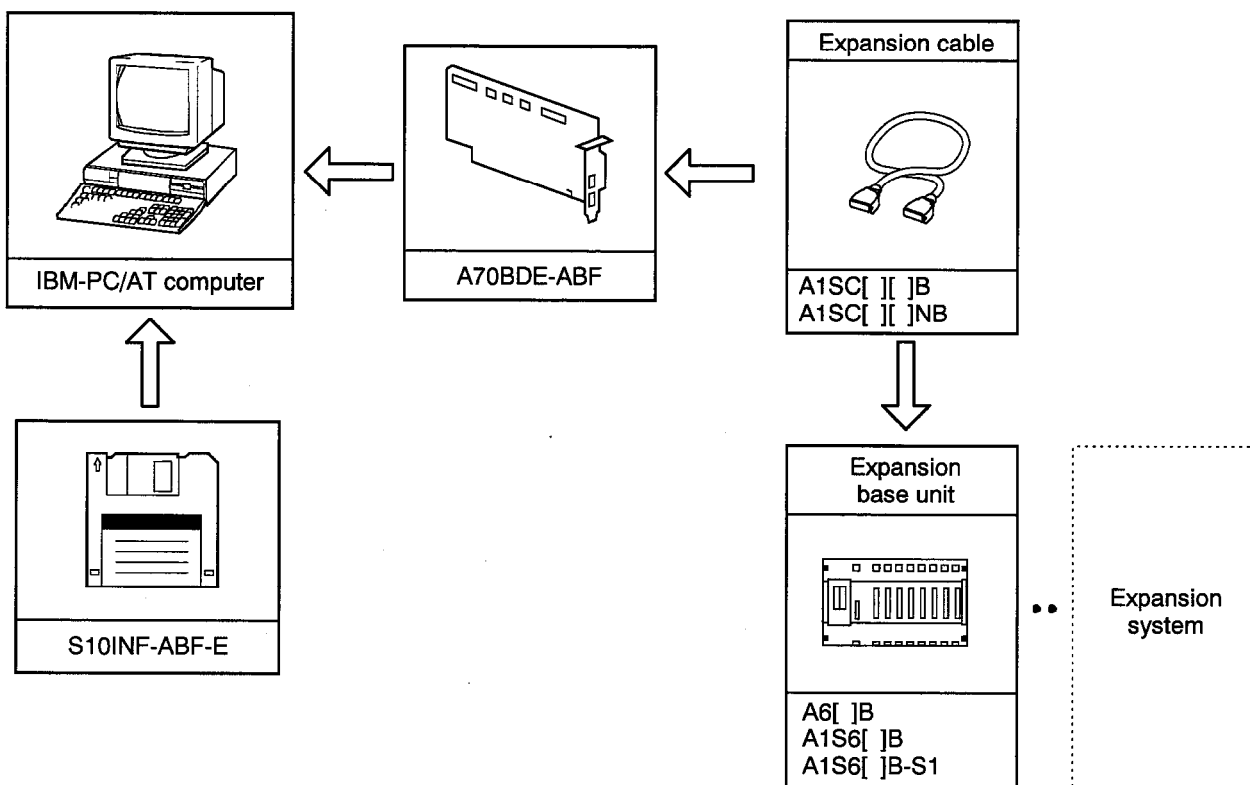

[ ] This indicates an arbitrary character string.

#### CHECKPOINTS

- The expansion bases can be connected up to 7 tiers when the A series is used and up to 3 tiers when the AnS series is used.
- The A6SIMX64Y64 cannot be connected since no power can be supplied.

### 2.2 Checkpoints for System Configuration

The ABF board can be installed in an IBM-PC/AT computer and used to control the Input/Output modules and special function modules on the expansion bases. Some checkpoints to be heeded when configuring a system are given below.

(1) System configuration

In a system which uses the A70BDE-ABF, the IBM-PC/AT computer is used in place of the basic base, and the bases which are connected all serve as expansion bases.

(2) Number of usable installation slots

Any of the slots provided by the ISA bus can be used as the installation slots.

(3) Number of boards which can be installed

Only one ABF board per IBM-PC/AT computer can be installed.

(4) Number of expansion tiers and number of Input/Output points

The number of expansion tiers and number of Input/Output points are given below.

	Number of expansion tiers	Number of Input/Output points
A series	Max. 7 tiers	Max. 3,584 points (64 points x 8 slots x 7 tiers)
AnS series	Max. 3 tiers	Max. 1,536 points (64 points x 8 slots x 3 tiers)

(5) Use with other boards

When the ABF board is to be used in the same computer with the MELSECNET board made by Mitsubishi or a board of some other maker, the board switches must be set in such a way that the settings are not duplicated for the Input/Output addresses, memory addresses, etc.

(6) Total extension distance

The total extension distance is given below: it differs according to the sequencer type.

Sequencer type	Total extension distance
A series	6.6 m
AnS series	6 m

(7) Combinations of usable expansion bases and expansion cables

The table below gives the usable combinations of expansion bases and expansion cables. The A5[ ]B and A1S5[ ]B expansion base units cannot be used.

[ ] This indicates an arbitrary character string.

Expansion base type	Cable model name	Cable length	Maximum number of expansion tiers
A62B A65B A68B (A series type)	A1SC05NB	0.45 m	Max. 7 tiers
	A1SC07NB	0.7 m	
	A1SC30NB	3 m	
	A1SC50NB	5 m	
A1S65B A1S68B A1S65B-S1 A1S68B-S1 (AnS series type)	A1SC03B	0.3 m	Max. 3 tiers
	A1SC07B	0.7 m	
	A1SC12B	1.2 m	
	A1SC30B	3 m	
	A1SC60B	6 m	

- (8) Input/Output modules and special function modules which can be controlled  
Any Input/Output module or special function module supported by the A series or AnS series can be controlled by the ABF board.  
Typical modules are listed below.

[Input/Output modules]

AC input modules, DC input modules, AC output modules, input/output mixed modules, etc.

[Special function modules]

High-speed counter modules, A/D converter modules, D/A converter modules, temperature/digital converter modules, analog Input/Output modules, MELSECNET/MINI-S3 master modules, etc.

For further details, refer to Appendix 1.

- (9) Specifications of IBM-PC/AT computer which can be used
- |                        |                            |
|------------------------|----------------------------|
| CPU:                   | i486 (25 MHz) or higher    |
| Memory:                | 16 M bytes or more         |
| Free hard disk memory: | 16.5 M bytes or more       |
| Operating system:      | Windows NT Workstation 4.0 |

## 3 SPECIFICATIONS

### 3.1 General Specifications

(1) The general specifications of the ABF board are provided in Table 3.1 below.

**Table 3.1 General Specifications**

Item	Specification				
Usage environment temperature	0 to 55°C				
Storage environment temperature	-20 to 75°C				
Usage environment humidity	10 to 90% RH, No. condensation formation				
Storage environment humidity	10 to 90% RH, No. condensation formation				
Anti-vibration	In compliance with IEC1131-2	When the vibration is intermittent			Sweep cycles  10 cycles for X, Y and Z directions (80 minutes)
		Frequency	Acceleration	Amplitude	
		10 to 57 Hz	—	0.075 mm (0.003 in.)	
		57 to 150 Hz	9.8 m/s <sup>2</sup> (1g)	—	
		When the vibration is continuous			
		Frequency	Acceleration	Amplitude	
		10 to 57 Hz	—	0.035 mm (0.001 in.)	
57 to 150 Hz	4.9 m/s <sup>2</sup> (0.5g)	—			
Anti-shock	In compliance with IEC1131-2 (147 m/s <sup>2</sup> (15g), 3 times each in 3 directions)				
Noise resistance	1500 Vp-p noise voltage, 1 μs noise width, 25 to 60 Hz noise frequency (generated by noise simulator)				
Usage environment	No corrosive gases				
Operating headroom	Max. 2000 mm (6561.6 ft.)				
Installation location	General-purpose IBM-PC/AT computer installed in control board				
Overvoltage category (see *1)	II or under				
Pollution level (see *2)	2 or under				

(\*1) This denotes which power distribution area from the public distribution network to the in-plant machine system the module is expected to be connected to. Category II applies to modules whose power is supplied from a fixed facility. The maximum surge voltage to which a module with a voltage rating of 300 V is specified at 2500 V.

- (\*2) This index denotes the extent to which conductive substances are generated in the environment where the module concerned is used. Only pollution from non-conductive substances is generated at pollution level 2. However, in the environment at this level, conductivity may arise temporarily due to congelation, according to this stipulation.
- (\*3) The specifications for the IBM-PC/AT computer unit apply as general specifications after the ABF board has been installed.

#### 3.2 Performance Specifications

Table 3.2 Performance Specifications

Item		Specification
Personal computer interface	Area occupied by memory	20 K bytes from 0C0000H to 0ECFFFH occupied
	Area occupied by I/O	(1) One of the following areas is selected for the ABF I/O: 1100H to 115FH 1300H to 135FH 2100H to 215FH 2300H to 235FH. Occupies 96 bites  (2) One of the following areas is selected for the FA controller dedicated I/O: 10E0H to 10FFH F100H to F11FH. Occupies 32 bytes
	Interrupt No.	IT0 Set to permanent disabling. IT1 3, 4, 5, 7, 10, 11, 12 or 15 selected.
Expansion bus		A-bus
Controlled modules		All input modules, all output modules, special function modules (some restrictions apply) (see*1)
A-bus interface	No. of input/output points	A type: Max. 3,584 points (X/Y0 to DFF) AnS type: Max. 1,536 (X/Y0 to 5FF);
	Special module buffer RAM	16 K bytes
No. of slots occupied		1 slot (ISA bus)
No. of boards installed		1 board per computer
Current consumption		370 mA (5 V DC)
Dimensions		162 x 102 mm (63.78 x 40.16 in.)
Weight		0.13 kg (0.286 lb.)

(\*1) The installation methods for the sequencer Input/Output modules, special function modules, expansion base units, expansion cables, etc. must comply with the A series/Ans series sequencer specifications.

# 4 NAMES OF THE PARTS AND THEIR SETTINGS

## 4.1 Handling Precautions

---

Described below are the handling precautions of the ABF board.

- (1) Mounted on the PCB of the ABF board are electronic components which are susceptible to static electricity. Therefore, do not directly touch the conductive parts or electrical components on the PCB.
- (2) When installing the ABF board, hold it only by the edges of the mounting fixtures or edges of the PCB and insert the connector into the socket securely.
- (3) Do not drop the ABF board or subject it to strong impact.
- (4) Do not remove the ABF board's mounting fixtures or PCB module.
- (5) When mounting the ABF board, ensure that scraps of wiring and other foreign matter will not enter from the top.
- (6) Tighten the screws (M4) securing the optional board using a tightening torque which is within the range of 117.6 to 186.2 N·cm (12 to 19 kg·cm).

[Prevention of failures caused by static electricity]

- (1) When storing or transporting the ABF board, be absolutely sure to place it inside an anti-static bag.
- (2) Before installing the ABF board, discharge any static electricity which may have accumulated in your body since static electricity can cause failures.
- (3) Handle the ABF board in a location which is free from static electricity.

## 4. NAMES OF THE PARTS AND THEIR SETTINGS

MELSEC

### 4.2 Names of Parts

The names of the parts on the ABF board are shown below.

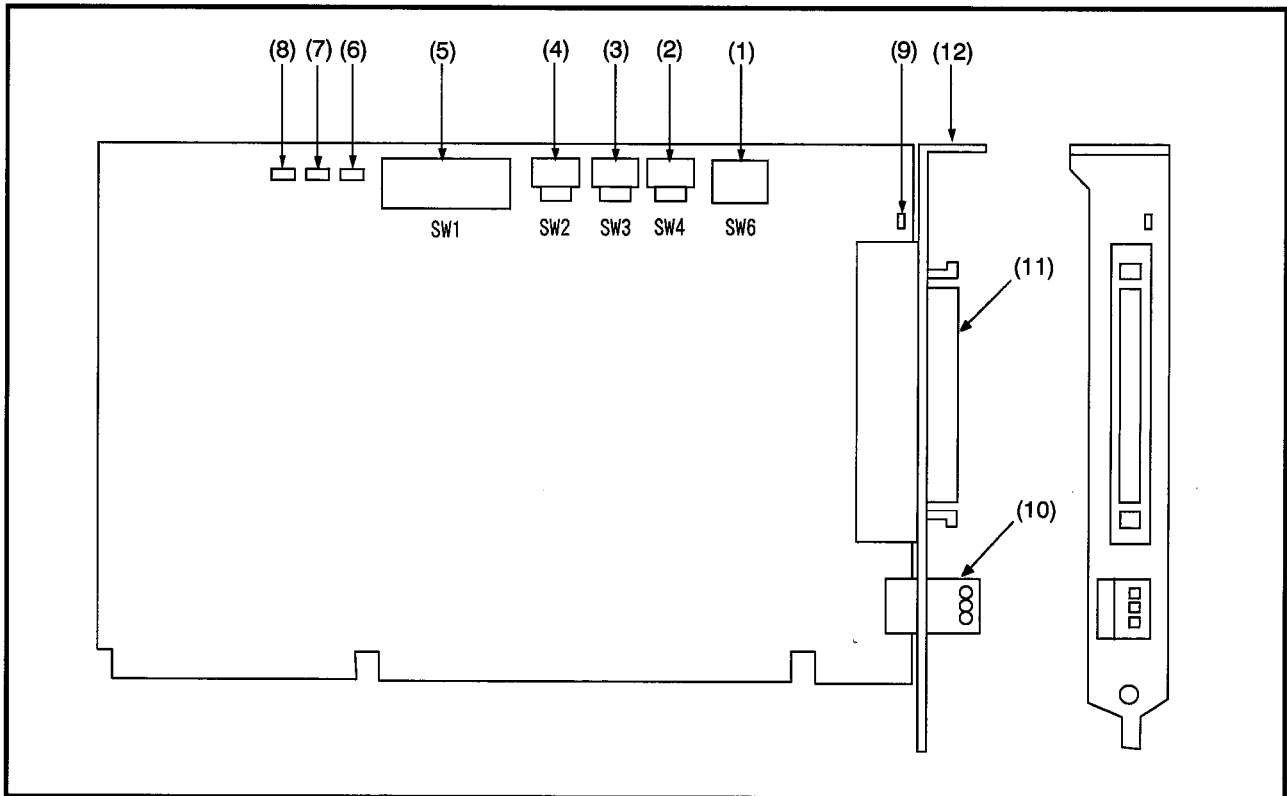

No.	Part	Switch No.	Description
(1)	Input/Output address setting switches	SW6-1 to 4	These set the Input/Output addresses occupied by the board.
(2)	Memory address setting switches	SW4-0 to 9	These set the addresses of the memory area occupied by the interface board.
(3)	Interrupt signal setting 1	SW3-0 to 9	Not used (cannot be set)
(4)	Interrupt signal setting 2	SW2-0 to 9	Using rotary switches, these set the number by which the operating system identifies the interface board.
(5)	User-specified setting switches	SW1-1 to 8	These set the memory access type, time selections for driver start error, and detection selections for abnormal internal temperature error.

No.	Part	Description
(6)	OS LED	This displays the operating status, errors, etc.
(7)	ABF LED	This displays the operating status, errors, etc.
(8)	ERROR LED	This displays the operating status, errors, etc.
(9)	WDT ERROR LED	This displays the operating status, errors, etc.
(10)	Error output connectors	These output signals to external modules when an error has occurred.
(11)	Expansion connector	This is an A-bus interface for connecting the sequencer with the IBM-PC/AT computer.
(12)	Mounting bracket	This secures the ABF board to the IBM-PC/AT computer.



### 4.3 Parts Settings

This item describes how the setting switches on the interface board are set.

Be absolutely sure to turn off the power supplied to the IBM-PC/AT computer before setting the switches.

- (1) Input/Output address setting (Refer to item 4.3.1)
- (2) Memory address setting (Refer to item 4.3.2)
- (3) Interrupt signal setting (Refer to item 4.3.3)
- (4) User-specified setting (Refer to item 4.3.4)

#### 4.3.1 Input/Output Address Setting

- (1) These switches set the Input/Output addresses occupied by the board.

SW6-1	SW6-2	Input/Output address
OFF	OFF	2300 to 235Fh
OFF	ON	2100 to 215Fh
ON	OFF	1300 to 135Fh
ON	ON	1100 to 115Fh (factory setting)

- (2) The following error detection Input/Output address is occupied by the error detection Input/Output address setting.

SW6-3	Error detection Input/Output address
OFF	F100 to F11Fh
ON	10E0 to 10FFh (factory setting)

- (3) Leave the setting at OFF ("enable") for the error detection function.

SW6-4	Error detection function enable/disable
OFF	Enable (factory setting)
ON	Disable

[NOTE]

The switches must be set in such a way that the settings are not duplicated for the Input/Output addresses of other option boards.

## 4.3.2 Memory Address Setting

(1) Setting the addresses of the shared memory to be occupied by the ABF board.

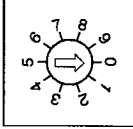
SW4	Switch No.	Memory address
	0	C000h to C4FFFh
	1	C8000h to CCFFFh (factory setting)
	2	D0000h to D4FFFh
	3	D8000h to DCFFFh
	4	E0000h to E4FFFh
	5	E8000h to ECFFFh
	6	Not used (cannot be set)
	7	Not used (cannot be set)
	8	Not used (cannot be set)
	9	Not used (cannot be set)

[NOTE]

Set the switches in such a way that their settings will not duplicate the settings of the shared memory areas of other optional boards.

Normally, the interface board cannot be installed in addresses C0000 to C7FFFh because this is where the video BIOS is.

## 4. NAMES OF THE PARTS AND THEIR SETTINGS

MELSEC

### 4.3.3 Interrupt Signal Setting

The ABF board interrupt signal setting is provided as a number for identifying from which optional board the operating system was accessed when the operating system is accessed from an ABF board.

- (1) The numbers available to the switch for setting the interrupt signals and whether setting is possible or not are shown below.

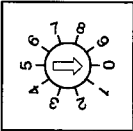
SW2	Switch No.	Setting enabled/disabled	IRQ No.
	0	Enabled (disabled when serial port 2 is used)	3
	1	Enabled (disabled when serial port 1 is used)	4
	2	Enabled (disabled when parallel port 2 is used)	5
	3	Enabled (disabled when parallel port 1 is used)	7
	4	Enabled (factory setting)	10
	5	Enabled	11
	6	Enabled (disabled when PS/2 mouse is used)	12
	7	Enabled	15
	8	(Setting prohibited)	—
	9	(Setting prohibited)	—

[NOTE]

Set the switch in such a way that its setting will not duplicate the interrupt signal settings of other optional boards.

For SW3, the switch No. must be kept to "8" and disabled.

## 4.3.4 User-Specified Setting

(1) Memory access type selection

This switch is used to set the memory range applying when the IBM-PC/AT computer unit accesses the shared memory of the ABF board.

SW1-5	Memory access type selection
OFF	8-bit access
ON	16-bit access (factory setting)

[NOTE]

Depending on the type of board, proper operation may not be possible with the following installation. If this is the case, change the installation location.

(a) When the switches have been set to 16 bits (128 k)

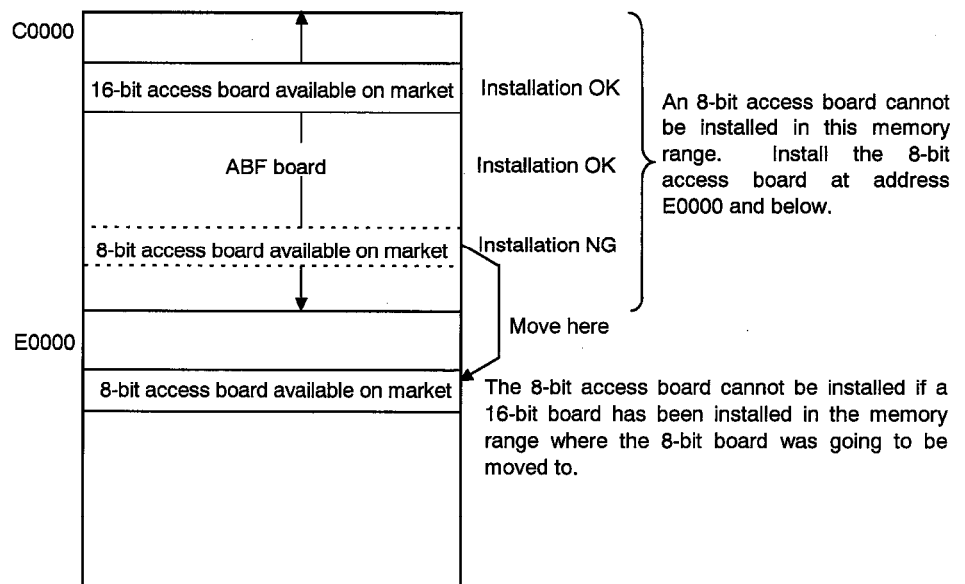

The same applies when the ABF board has been installed in an area starting with address E0000 and below.

## 4. NAMES OF THE PARTS AND THEIR SETTINGS

MELSEC

(b) When the switches have been set to 8 bits

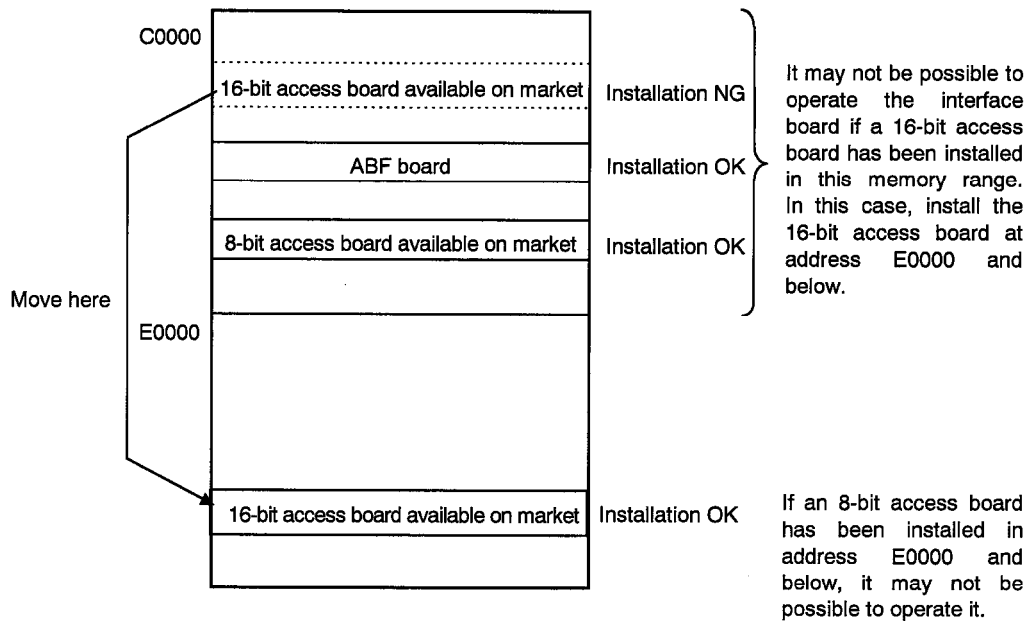

The same applies when the ABF board has been installed in an area starting with address E0000.

(2) Driver start error time selection

This switch is used to select the time taken to detect the error when the driver of the operating system of the IBM-PC/AT computer or ABF board has failed to start up properly.

SW1-7	Driver start error time selection
OFF	Error is detected after approx. 6 min. 40 sec. have elapsed (factory setting).
ON	Error is detected after approx. 3 min. 20 sec. have elapsed.

(3) Abnormal internal temperature error detection selection

This switch is used to select the internal temperature ceiling. When a temperature inside the IBM-PC/AT computer exceeding this ceiling is detected, an error results.

SW1-8	Abnormal internal temperature error detection selection
OFF	An error results when a temperature inside unit exceeding 45°C (factory setting) is detected.
ON	An error results when a temperature inside unit exceeding 55°C is detected.

[NOTE]

SW1-1 to SW1-4 are not used. SW1-6 is always kept at the OFF setting.

## 4. NAMES OF THE PARTS AND THEIR SETTINGS

MELSEC

### 4.3.5 Statuses of LED Displays

The statuses indicated by the LED displays provided are given in the table below.

	Operating status	LED display				External alarm output	
		OS LED	ABF LED	ERR LED	WDT ERR LED		
1	System startup error	Flashing	OFF	OFF	OFF	ON	
3	System WDT error	OFF	OFF	Flashing	ON		
4	User WDT error				OFF		
5	Abnormal internal temperature rise error	ON	ON	ON	OFF		
6	AC cut-off detection error						
7	A-bus reset error						OFF
8	A-bus trouble error processing						
9	Gate array self-diagnosis error						OFF
						OFF	

(1) System startup error

This error results when the operating system of the IBM-PC/AT computer or interface board driver has failed to start up properly.

(2) System WDT error

This error results when the operating system of the IBM-PC/AT computer has run out of control and the WDT count has reached the setting.

(4) User WDT error

This error results when the application program has run out of control or the a time-out has occurred for the timer setting since the processing time was exceeded.

(5) Abnormal internal temperature rise error

This error results when the temperature inside the IBM-PC/AT computer has exceeded the rating.

(6) AC cut-off detection error

This error results when the power supply module has detected an instantaneous power failure of a magnitude which did not cause the hardware to be reset.

(7) A-bus reset error processing

Reset processing is conducted by the driver after an external alarm has been output when trouble has occurred in the A-bus during normal operation.

(8) A-bus error processing

This is the resetting processing performed by the driver when an error has occurred.

(9) Gate array self-diagnosis error

This error occurs during driver self-diagnosis.

(\*1) Refer to Chapter 10 "TROUBLESHOOTING" for remedies when an error occurs.

## 5 POWER SUPPLY MODULES

Described below are the specifications and selection criterion of the power supply modules.

### 5.1 Specifications

#### 5.1.1 Power Supply Module Specifications

The power supply module specifications are listed in the following tables.

(1) Standard type of power supply modules

**Table 5.1 Specifications of standard type of power supply modules**

Item	Specification					
	A61P	A62P	A63P	A65P	A66P	
Base unit installation position	Power supply module installation slot				I/O module installation slot	
Input power source	100 to 120 V AC +10/-15% (85 to 132 V AC)		24 V DC +30/-35%	100 to 120 V AC +10/-15% (85 to 132 V)		
	200 to 240 V AC +10/-15% (170 to 264 V AC)		(15.6 to 31.2 V DC)	200 to 240 V AC +10/-15% (170 to 264 V AC)		
Input power line frequency	50/60 Hz ±5%		—	50/60 Hz ±5%		
Maximum apparent input power	130 VA	155 VA	65 W	110 VA	95 VA	
Inrush current	Less than 20 A, 8 ms		Less than 100 A, 1 ms	Less than 20 A, 8 ms		
Rated output current	5 V DC	8 A	5 A	8 A	2 A	—
	24 V DC	—	0.8 A	—	1.5 A	1.2 A
*1 Overcurrent protection	5 V DC	More than 8.8 A	More than 5.5 A	More than 8.5 A	More than 2.2 A	—
	24 V DC	—	More than 1.2A	—	More than 2.3A	More than 1.7A
*2 Overvoltage protection	5 V DC	5.5 to 6.5 V	5.5 to 6.5 V	5.5 to 6.5 V	5.5 to 6.5 V	—
	DC 24 V	—				
Efficiency	More than 65%					
Withstand voltage	1500 V AC between all AC external connectors and ground for 1 minute 500 V AC between all DC external connectors and ground for 1 minute					
Immunity from noise	1500 Vp-p noise voltage		500 Vp-p noise voltage	1500 Vp-p noise voltage		
Insulation resistance	More than 5 MΩ as measured with megger between all AC external connectors and ground					
Power display	Power LED display					
Terminal screw size	M4 x 0.7 x 6				M3 x 0.5 x 6	
Compatible cable size	0.75 to 2 mm <sup>2</sup>					
Compatible solderless terminals	R1.25-4, R2-4, RAV1.25-4, RAV2-4				R1.25-3, R2-3, RAV1.25-3, RAV2-3	
Compatible tightening torque	118 N•cm (12 kg•cm)				69 N•cm (7 kg•cm)	
Dimensions (mm)	250 x 55 x 121				250 x 37.5 x 12	
Weight (kg)	0.98	0.94	0.8	0.94	0.75	
*3 Allowable instantaneous stop time	Less than 20 ms		Less than 1 ms	Less than 20 ms	—	

**REMARKS**

Number of slots occupied by the A66P is 1.



## 5. POWER SUPPLY MODULES

MELSEC-A

(2) Power supply modules authorized to display CE mark

**Table 5.2 Specifications of power supply modules authorized to display CE mark**

Item		Specification	
		A61PEU	A62PEU
Base unit installation position		Power supply module installation slot	
Input power source		100 to 120 V/200 to 240 V AC +10/-15%	
Input power line frequency		50/60 Hz ±5%	
Maximum apparent input power		130 VA	155 VA
Inrush current		Less than 20 A, 8 ms	
*1 Rated output current	5 V DC	8 A	5 A
	24 V DC	—	0.8 A
*2 Overcurrent protection	5 V DC	More than 8.8 A	More than 5.5 A
	24 V DC	—	More than 1.2 A
Overvoltage protection	5 V DC	5.5 to 6.5 V	—
	24 V DC	—	—
Efficiency		More than 65%	
Dielectric strength	Between primary and FG	2830 V AC	2830 V AC
Immunity from noise		Noise voltage, IEC801-4: 2 kV, 1500 Vp-p	
Power display		Power LED display	
Terminal screw size		M4 x 0.7 x 6	
Compatible cable size		0.75 to 2 mm <sup>2</sup>	
Compatible solderless terminals		R1.25-4, R2-4	
Compatible tightening torque		118 N•cm (12 kg•cm)	
Dimensions (mm)		250 x 55 x 121	
Weight (kg)		0.8	0.9
*3 Allowable instantaneous stop time		Less than 20 ms	

### CHECKPOINTS

#### \*1 Overcurrent protection

When a current in excess of the specification flows to the 5 V DC or 24 V DC circuit, the overcurrent protection device cuts off the circuit and stops the system.

The LED display for the power supply module goes off or glows dimly due to the resulting voltage drop.

When this device has been activated, remove the cause of its activation such as the insufficient current capacity or short-circuiting, and then start up the system.

When the current flows at its normal value, the system performs the initial start operation.

#### \*2 Overvoltage protection

When an overvoltage of 5.5 V to 6.5 V is applied to the 5 V DC circuit, the overvoltage protection device cuts off the circuit and stops the system.

The LED display for the power supply module goes off. When the input power supply is set OFF and then back ON, the system is started again by the initial start operation.

If the system fails to start and the LED display remains off, the power supply module must be replaced.

#### \*3 Allowable instantaneous stop time

This denotes the allowable instantaneous stop time of the sequencer CPU. The length of this time is determined by the power supply module used.

The allowable instantaneous stop time for a system which uses the A63P/A1S63P is the time elapsing after the primary power of the regulated power supply which supplies the 24 V DC voltage to the A63P/A1S63P is turned off until the 24 V DC voltage reaches a level which is less than the specified voltage (15.6 V DC).

## 5. POWER SUPPLY MODULES

MELSEC-A

(3) Compact type of power supply modules

**Table 5.3 Specifications of compact type of power supply modules**

Item	Specification		
	A1S61P	A1S62P	A1S63P
Base unit installation position	Power supply module installation slot		
Input power source	100 to 120 V AC +10/-15% (85 to 132 V AC)		24 V DC +30/-35% (15.6 to 31.2 V DC)
	200 to 240 V AC +10/-15% (170 to 264 V AC)		
Input power line frequency	50/60 Hz $\pm$ 3 Hz		—
Maximum apparent input power	105 VA		41 W
Inrush current	Less than 20 A, 8 ms		Less than 81 A, 1 ms
Rated output current	5 V DC	5 A	3 A
	24 V DC $\pm$ 10%		0.6 A
*1 Overcurrent protection	5 V DC	More than 5.5 A	More than 3.3 A
	24 V DC		More than 0.66 A
*2 Overvoltage protection	5 V DC	5.5 to 6.5 V	5.5 to 6.5 V
	24 V DC		—
Efficiency	More than 65%		
Power display	Power LED display		
Terminal screw size	M3.5 x 7		
Compatible cable size	0.3 to 2 mm <sup>2</sup>		
Compatible solderless terminals	1.25-3.5, V1.25-YS3A, 2-3.5, 2-YS3A, V1.25-M3, V2-YS3A, V2-S3, V2-YS3A		
Compatible tightening torque	83 to 113 N•cm (8.5 to 11.5 kg•cm)		
Dimensions (mm)	130 x 55 x 94		
Weight (kg)	0.53	0.55	0.5
*3 Allowable instantaneous stop time	Less than 20 ms		Less than 1 ms

### CHECKPOINTS

#### \*1 Overcurrent protection

When a current in excess of the specification flows to the 5 V DC or 24 V DC circuit, the overcurrent protection device cuts off the circuit and stops the system.

The LED display for the power supply module goes off or glows dimly due to the resulting voltage drop.

When this device has been activated, remove the cause of its activation such as the insufficient current capacity or short-circuiting, and then start up the system.

When the current flows at its normal value, the system performs the initial start operation.

#### \*2 Overvoltage protection

When an overvoltage of 5.5 V to 6.5 V is applied to the 5 V DC circuit, the overvoltage protection device cuts off the circuit and stops the system.

The LED display for the power supply module goes off. When the input power supply is set OFF and then back ON, the system is started again by the initial start operation.

If the system fails to start and the LED display remains off, the power supply module must be replaced.

#### \*3 Allowable instantaneous stop time

This denotes the allowable instantaneous stop time of the sequencer CPU. The length of this time is determined by the power supply module used.

The allowable instantaneous stop time for a system which uses the A63P/A1S63P is the time elapsing after the primary power of the regulated power supply which supplies the 24 V DC voltage to the A63P/A1S63P is turned off until the 24 V DC voltage reaches a level which is less than the specified voltage (15.6 V DC).

## 5.1.2 Selection Criterion of Power Supply Modules

The selection criterion of a power supply module is the total current which is supplied by the power supply module and consumed by the I/O modules, special function modules and peripheral devices.

(1) Standard type

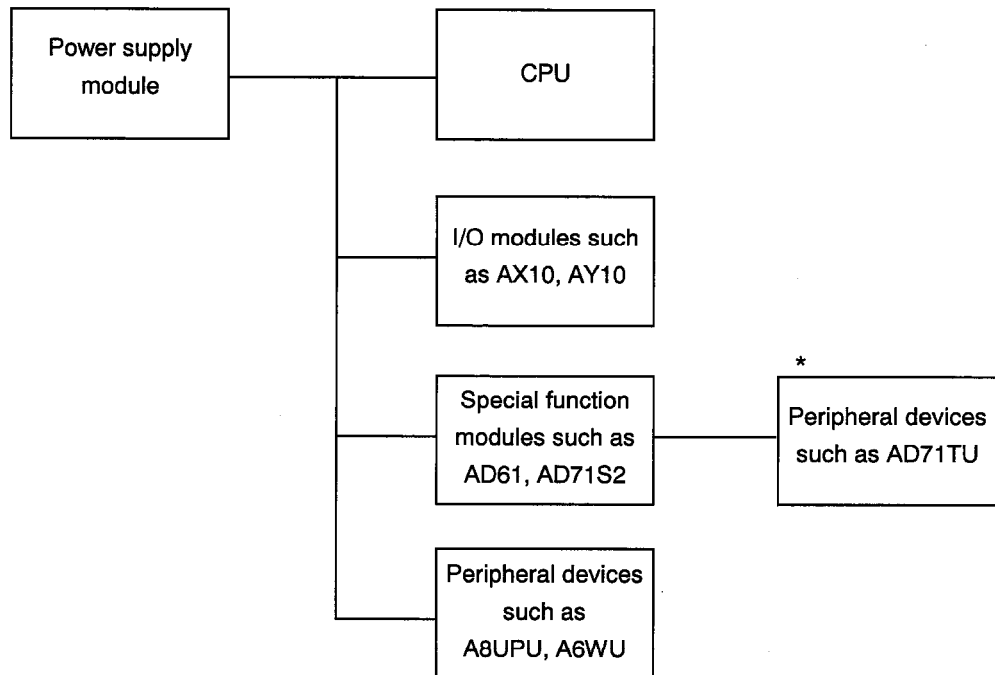

\* The current consumed by the peripheral devices connected to the special function modules should also be factored in when selecting the power supply module.

When, for instance, the AD71TU is connected to the AD71S2, the current consumed by the AD71TU must also be taken into account.

(2) Compact type

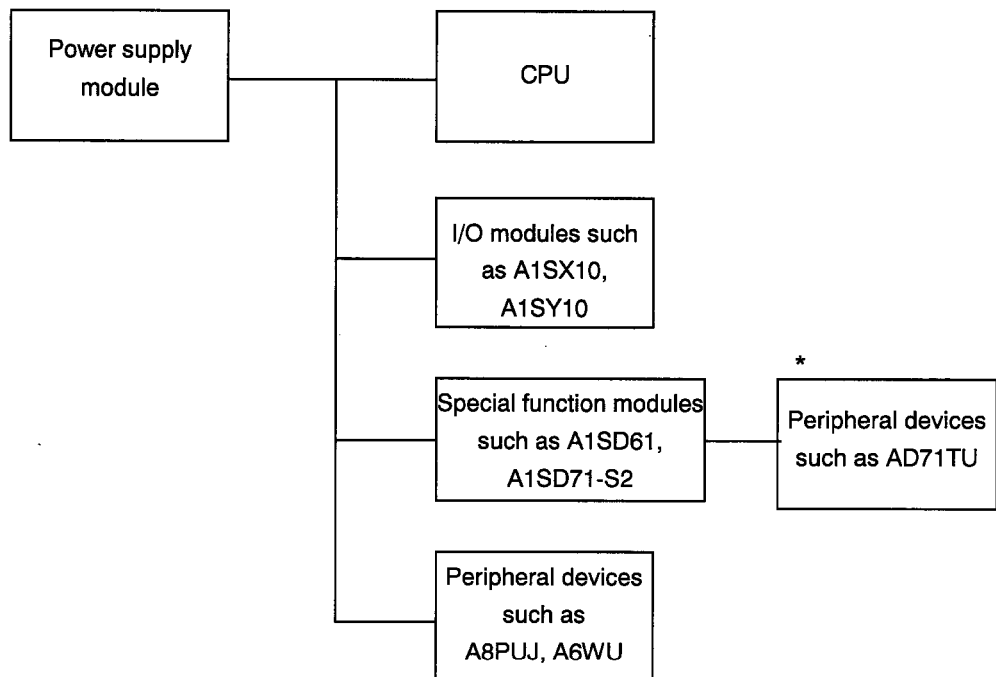

\* The current consumed by the peripheral devices connected to the special function modules should also be factored in when selecting the power supply module.

When, for instance, the AD71TU is connected to the A1SD71-S2, the current consumed by the AD71TU must also be taken into account.

(3) Precautions for using A66P

(a) Use the A66P with the right slot or far right slot of the base unit kept empty, kept for a dummy module or kept with a blank cover in place.

(b) The output current (24 V DC) of the A66P is determined as follows by the module installed on the left.

Module on left	Power supply module	Input module/ dummy module	Output module/ special function module	Empty slot																
Configuration	<table border="1"> <tr> <td></td> <td>Power supply module</td> <td>A66P</td> <td>Empty slot</td> </tr> </table>		Power supply module	A66P	Empty slot	<table border="1"> <tr> <td></td> <td>Input module/ dummy module</td> <td>A66P</td> <td>Empty slot</td> </tr> </table>		Input module/ dummy module	A66P	Empty slot	<table border="1"> <tr> <td></td> <td>Output module/ special function module</td> <td>A66P</td> <td>Empty slot</td> </tr> </table>		Output module/ special function module	A66P	Empty slot	<table border="1"> <tr> <td></td> <td>Empty slot</td> <td>A66P</td> <td>Empty slot</td> </tr> </table>		Empty slot	A66P	Empty slot
	Power supply module	A66P	Empty slot																	
	Input module/ dummy module	A66P	Empty slot																	
	Output module/ special function module	A66P	Empty slot																	
	Empty slot	A66P	Empty slot																	
24 V DC max. usable output current	0.5 A	1.2 A	1.0 A	1.5 A																

## 5. POWER SUPPLY MODULES

MELSEC-A

### 5.1.3 Fuse Specifications

The specifications of the fuses for the power supply modules and output modules are listed below.

Fuse specifications

Item Model name	GTH4	SM6.3A	MF51NM8	GP-32	HP-32	HP-70K	MP-20	MP-32	MP-32
Applications	For A61P, A61PEU, A62P, A62PEU, A65P, A66P power supply modules	For A63P power supply module	For AY11E, AY13E output modules	For AY20EU output module	For AY23 output module	For AY22 output module	For AY50, AY80 output modules	For AY60 output module	For AY60E output module
Type	Glass tube	Glass tube	Glass tube	Plug type	Plug type	Plug type	Plug type	Plug type	Plug type
Rated current	4 A	6.3 A	8 A	3.2 A	3.2 A	7 A	2 A	3.2 A	5 A
Dimensions (mm)	ø6 x 32	ø6 x 32	ø5.2 x 20	30.3 x 8 x 20	30.3 x 8 x 20	30.3 x 8 x 20	17.2 x 5.5 x 19	17.2 x 5.5 x 19	17.2 x 5.5 x 19

## 5.2 Handling

### 5.2.1 Handling Precautions



#### Danger

- Before proceeding with installation, wiring or other work, the power supply must be shut down externally for all phases concerned. Failure to heed this warning may result in electric shocks or damage to the product.
- When turning on the power to initiate operation after installation, wiring or other work has been performed, the accessory terminal covers must be mounted on the product. Failure to heed this warning may result in electric shocks.



#### Caution

- Install a module by first securely inserting the anchoring tabs at the bottom of the module into the anchoring holes of the base unit. Failure to install a module properly may cause malfunctioning or failures or the module may fall off.
- Tighten up all the terminal screws using the specified torque. Loose terminal screws can cause short-circuiting, a fire or malfunctioning.
- Take care not to allow chips, scraps of wire or other foreign matter to enter a module. This can cause a fire, failures or malfunctioning.
- Do not attempt to disassemble or remodel a module. This can cause failures, malfunctioning, injury or a fire.
- Turn off the power before installing or removing a module. Proceeding while the power is still supplied can cause the module to break down or malfunction.
- When replacing a fuse, use a fuse with the specified amperage. Using a fuse with a high capacity or using a wire instead of a fuse can cause a fire.

Described below are the precautions for handling the power supply module from its removal from the packing carton to its installation.

- (1) Do not drop the power supply module or subject it to strong impact since its casing, terminal board connectors and pin connectors are made of plastic.
- (2) Tighten up the module mounting screw (not necessary if in the normal operation status), terminal screw, etc. using a tightening torque within the ranges specified below.

Location of screws	Tightening torque range
Terminal screw of power supply module terminal board (M3 screw)	49 to 78 N•cm (58 kg•cm)
Terminal screw of power supply module terminal board (M4 screw)	93 to 137 N•cm (10 to 14 kg•cm)
Module mounting screw (not normally needed) (M4 screw)	78 to 118 N•cm (8 to 12 kg•cm)

- (3) When installing the module in the base unit, press it firmly so that the hook is locked to the base unit. To remove the module, press the hook, fully disengage the hook from the base unit, and pull the module toward you.

## 5.2.2 Names of parts

Described below are the names of the parts of the power supply modules.

### (1) Names of A61P and A61PEU module parts

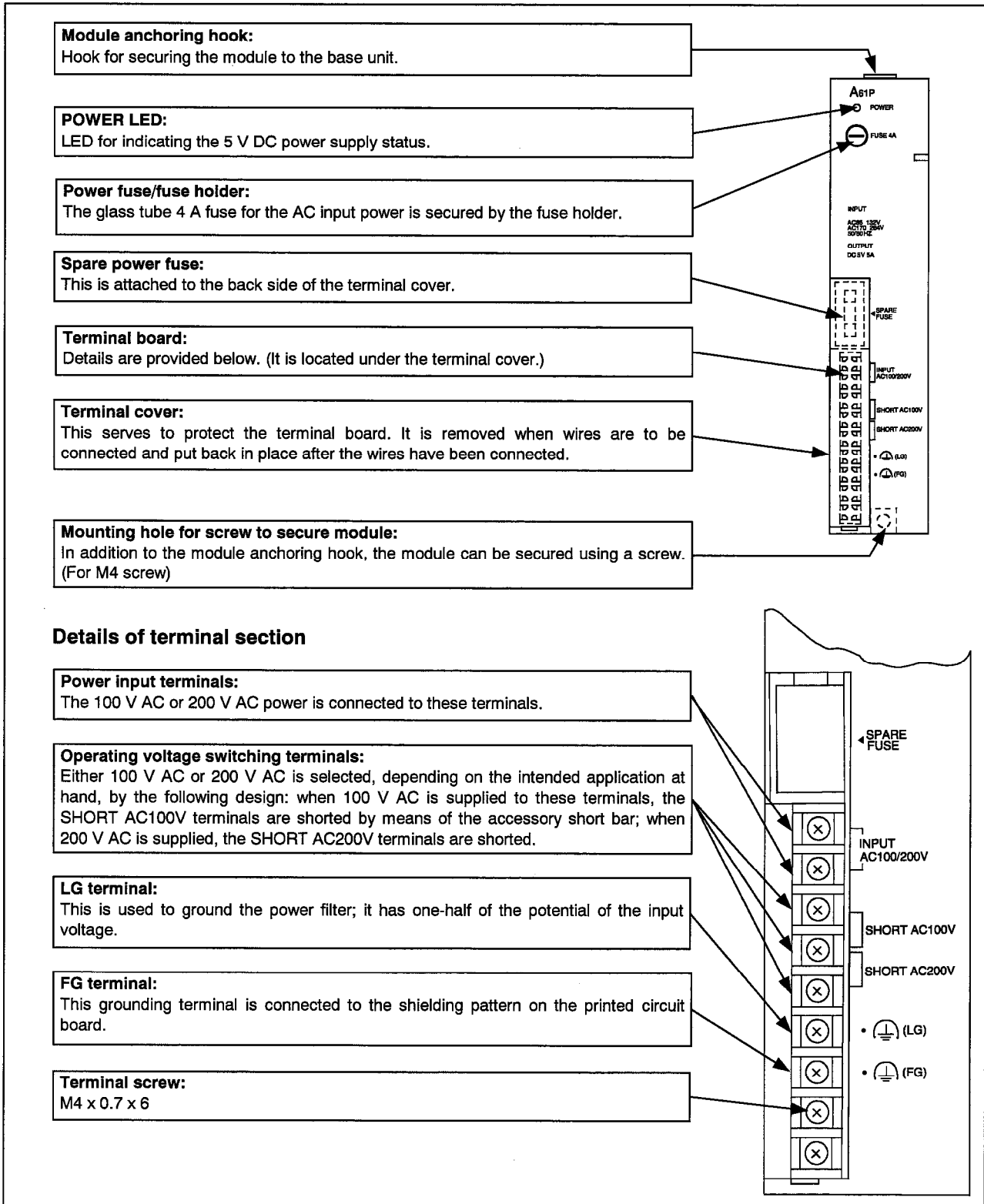

## (2) Names of A62P, A62PEU and A65P module parts

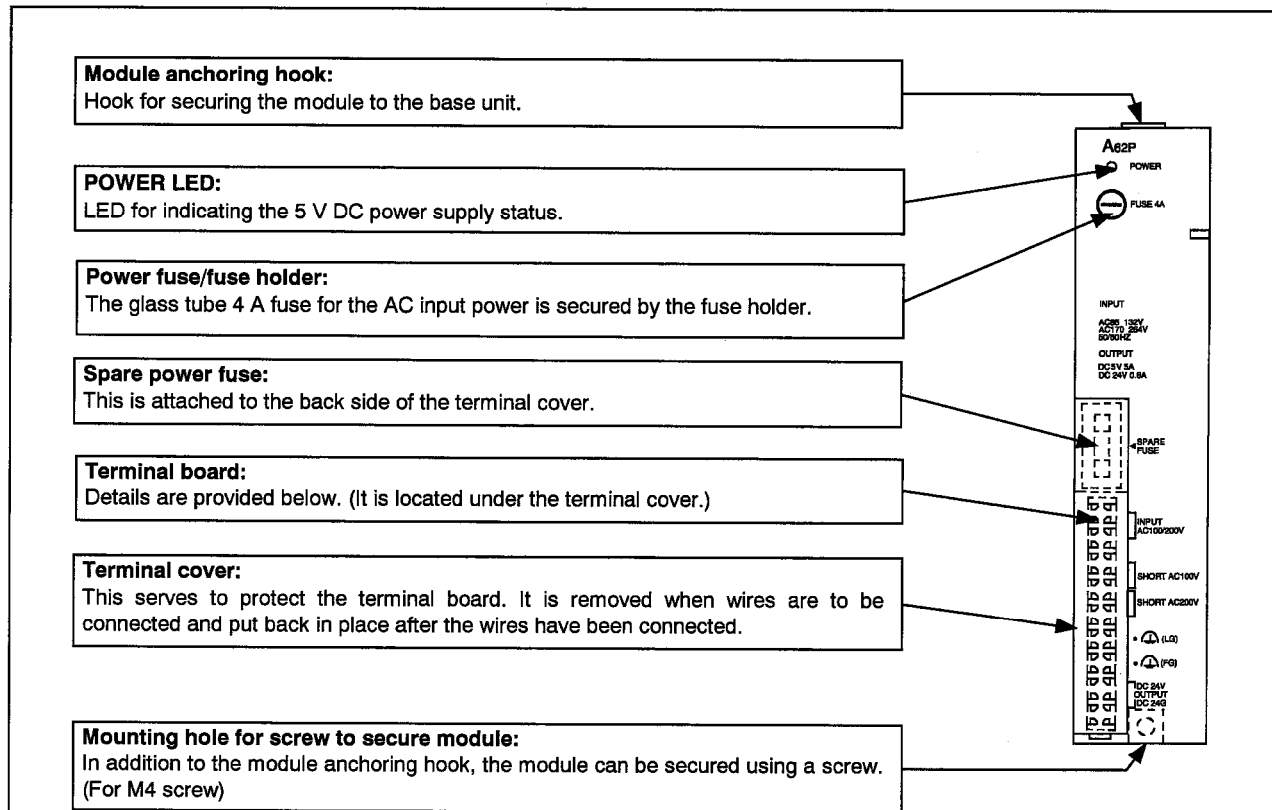

### Details of terminal section

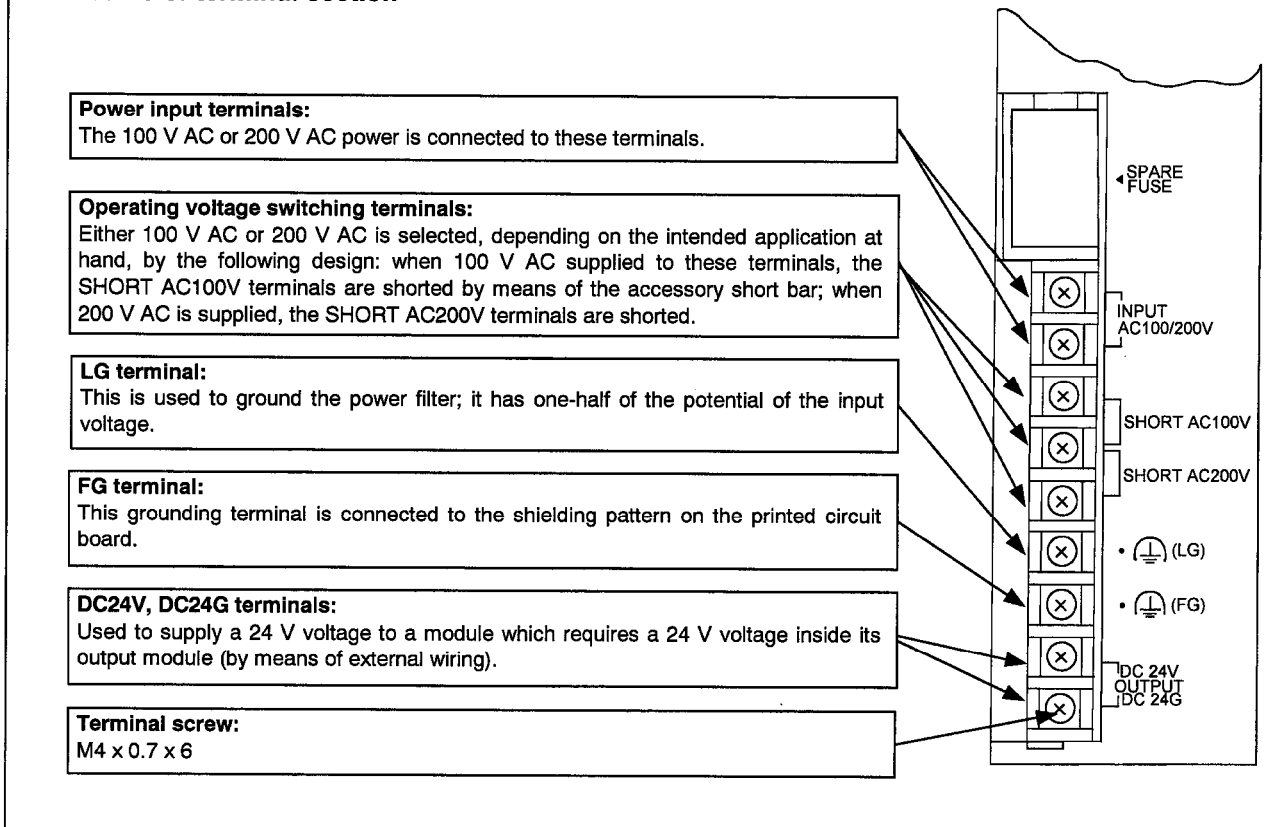



## (3) Names of A63P module parts

**Module anchoring hook:**  
Hook for securing the module to the base unit.

**POWER LED:**  
LED for indicating the 5 V DC power supply status.

**Power fuse/fuse holder:**  
The glass tube fuse for the DC input power is secured by the fuse holder.  
The fuse ratings are as follows:  
6.3 A (SM6.3A) for A63P,  
4 A (GTH4) for A67P.

**Spare power fuse:**  
This is attached to the back side of the terminal cover.

**Terminal board:**  
Details are provided below. (It is located under the terminal cover.)

**Terminal cover:**  
This serves to protect the terminal board. It is removed when wires are to be connected and put back in place after the wires have been connected.

**Mounting hole for screw to secure module:**  
In addition to the module anchoring hook, the module can be secured using a screw.  
(For M4 screw)

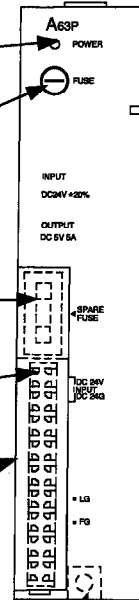

### Details of terminal section

**Power input terminals:**  
The 24 V DC power is connected to these terminals.  
Do not connect the "+" and "-" of the 24 V DC power in reverse: this will blow the fuse.

**LG terminal:**  
This is used to ground the power filter.

**FG terminal:**  
This grounding terminal is connected to the shielding pattern on the printed circuit board.

**Terminal screw:**  
M4 x 0.7 x 6

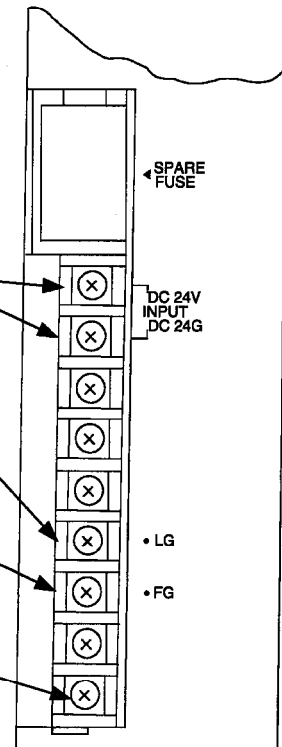

## (4) Names of A66P module parts

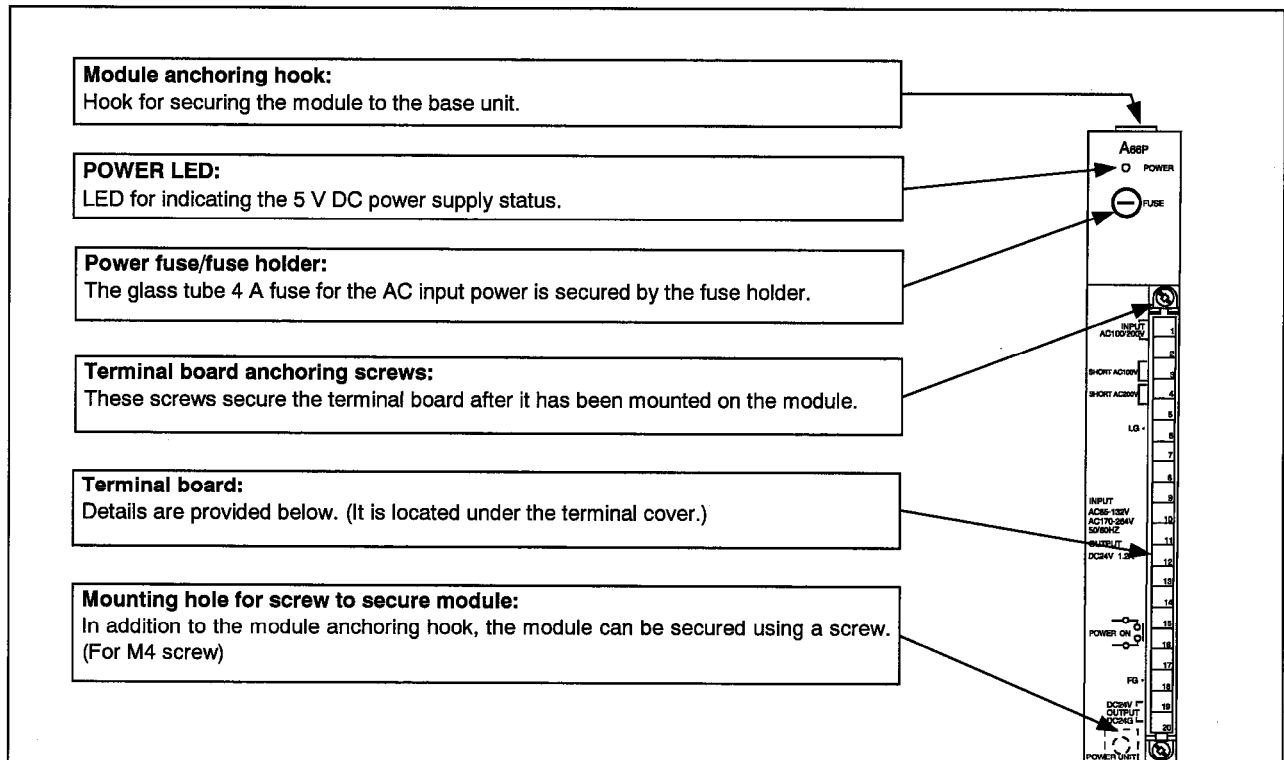

### Details of terminal section

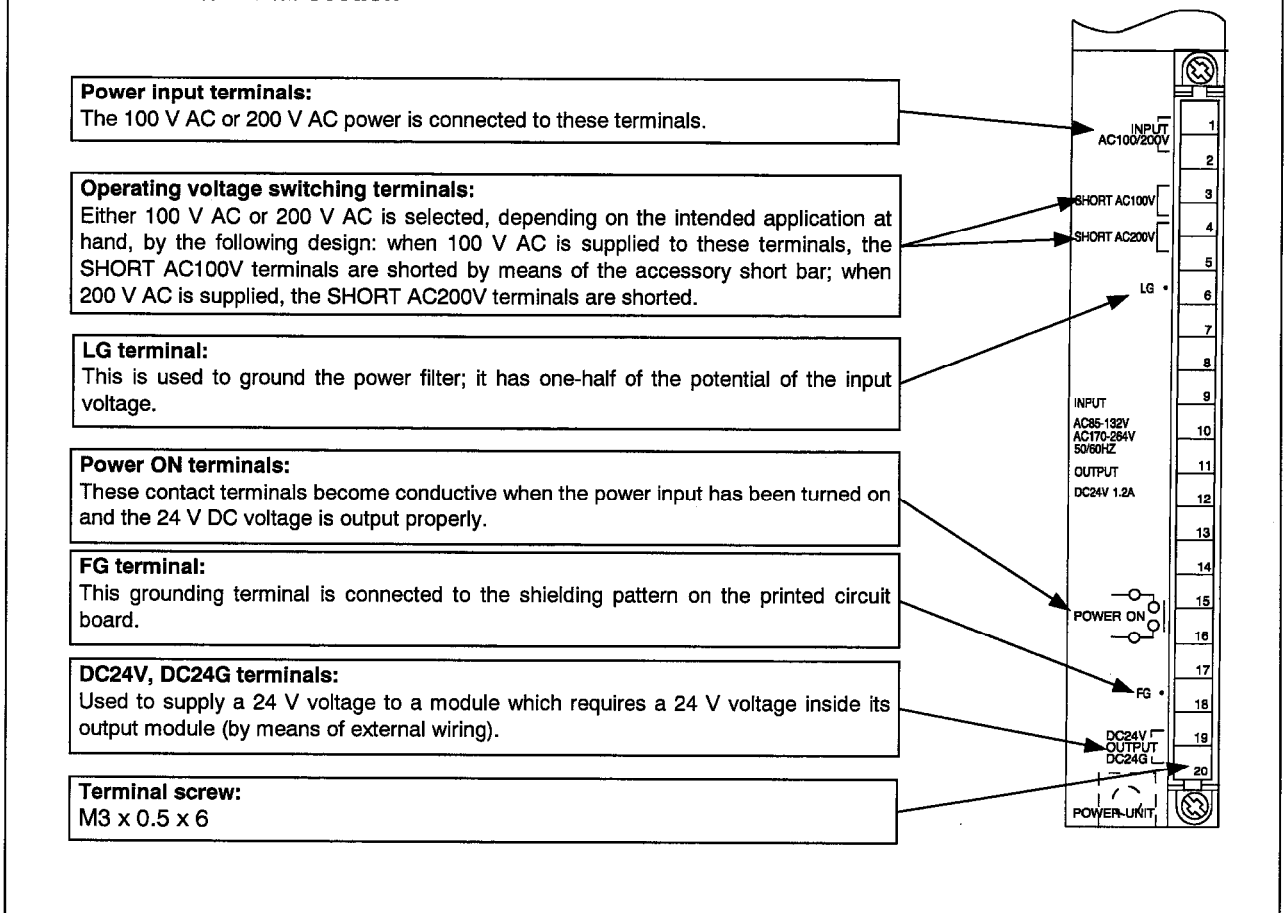

# 5. POWER SUPPLY MODULES

(5) Names of A1S61P , A1S62P and A1S63P module parts

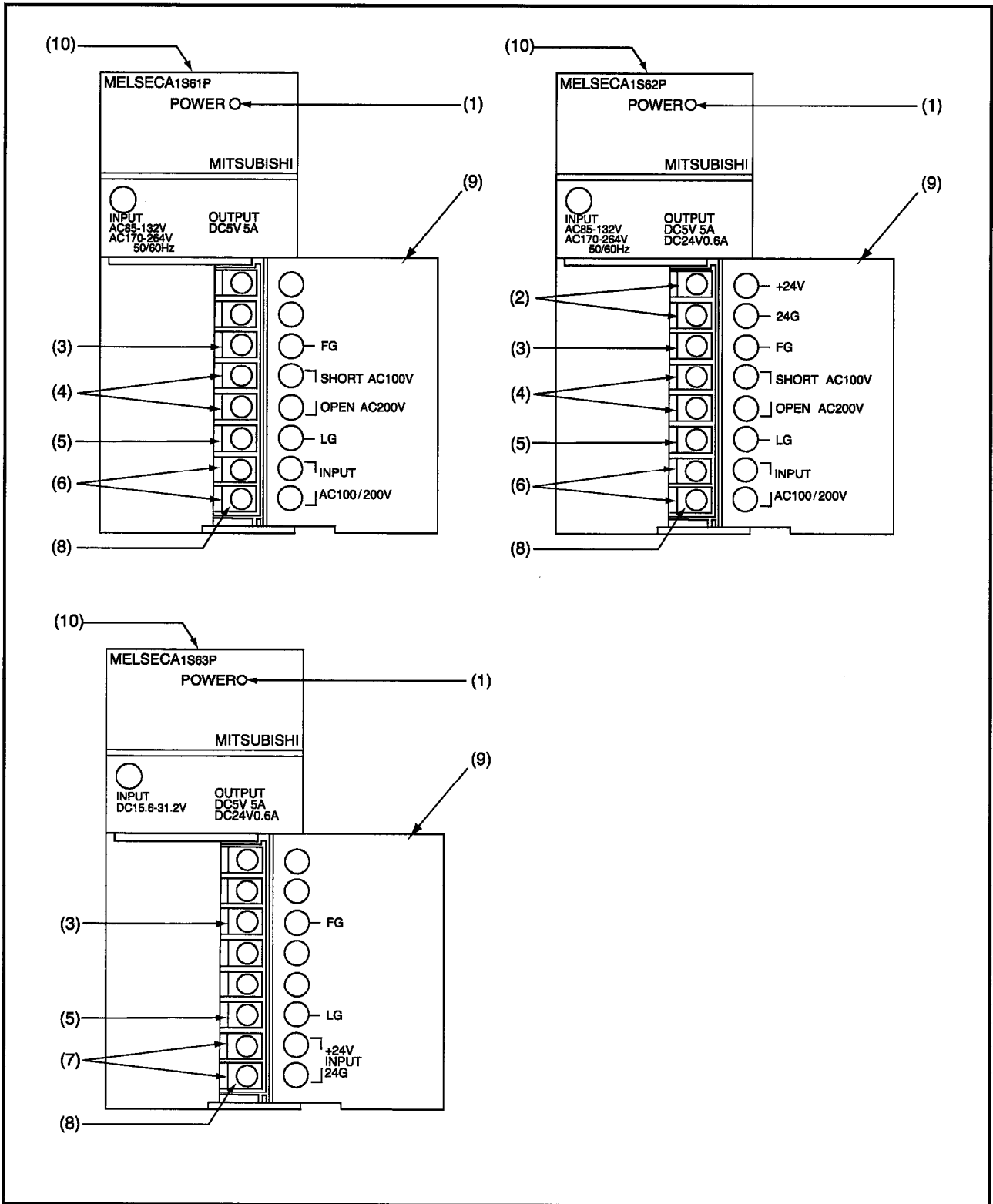

# 5. POWER SUPPLY MODULES

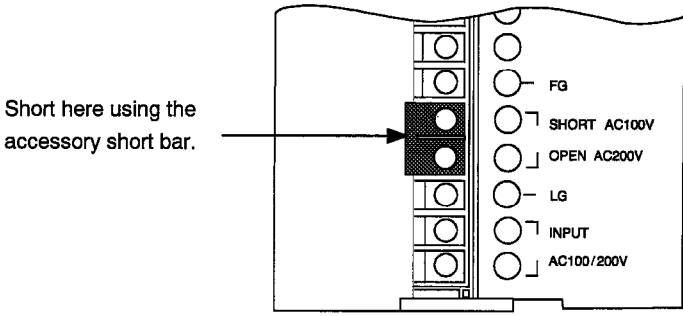
No.	Part	Function
(1)	POWER LED	LED for indicating the 5 V DC power.
(2)	DC24V, DC24G terminals	Used to supply a 24 V DC voltage to a module which requires a 24 V voltage inside its output module (by means of external wiring).
(3)	FG terminal	This grounding terminal is connected to the shielding pattern on the printed circuit board.
(4)	Operating voltage switching terminals	<p>When 100 V AC is supplied to these terminals, the terminals are shorted by means of the accessory short bar; when 200 V AC is supplied, the terminals are opened. In this way, either 100 V AC or 200 V AC is selected according to the intended application at hand.</p> <p>&lt;Setting when 100 V AC is the supply voltage used&gt;</p> 
(5)	LG terminal	This is used to ground the power filter. With the A1S61P and A1S62P, it has one-half of the potential of the input voltage.
(6)	Power input terminal	The 100 V AC or 200 V AC power supply is connected to this terminal.
(7)	Power input terminal	The 24 V DC power supply is connected to this terminal.
(8)	Terminal screw	M3.5 x 7
(9)	Terminal cover	For protecting the terminal board.
(10)	Module securing screw	For securing the module to the base unit.

### CHECKPOINTS

- (1) Do not set the supply voltage incorrectly since the following trouble will occur if the setting does not correspond to the supply voltage.

	Supply voltage	
	100 V AC	200 V AC
Set to 100 V AC (operating voltage switching terminals shorted)	—	Destruction of power supply module (CPU remains trouble-free)
Set to 200 V AC (operating voltage switching terminals open)	No trouble in module but CPU fails to operate	—

## 5.2.3 Settings

Depending on the supply voltage which is supplied to the A61P, A61PEU, A62P, A62PEU, A65P or A66P power supply module, the operating voltage switching terminals may need to be shorted by means of the short bar (supplied). Described below is the setting method.

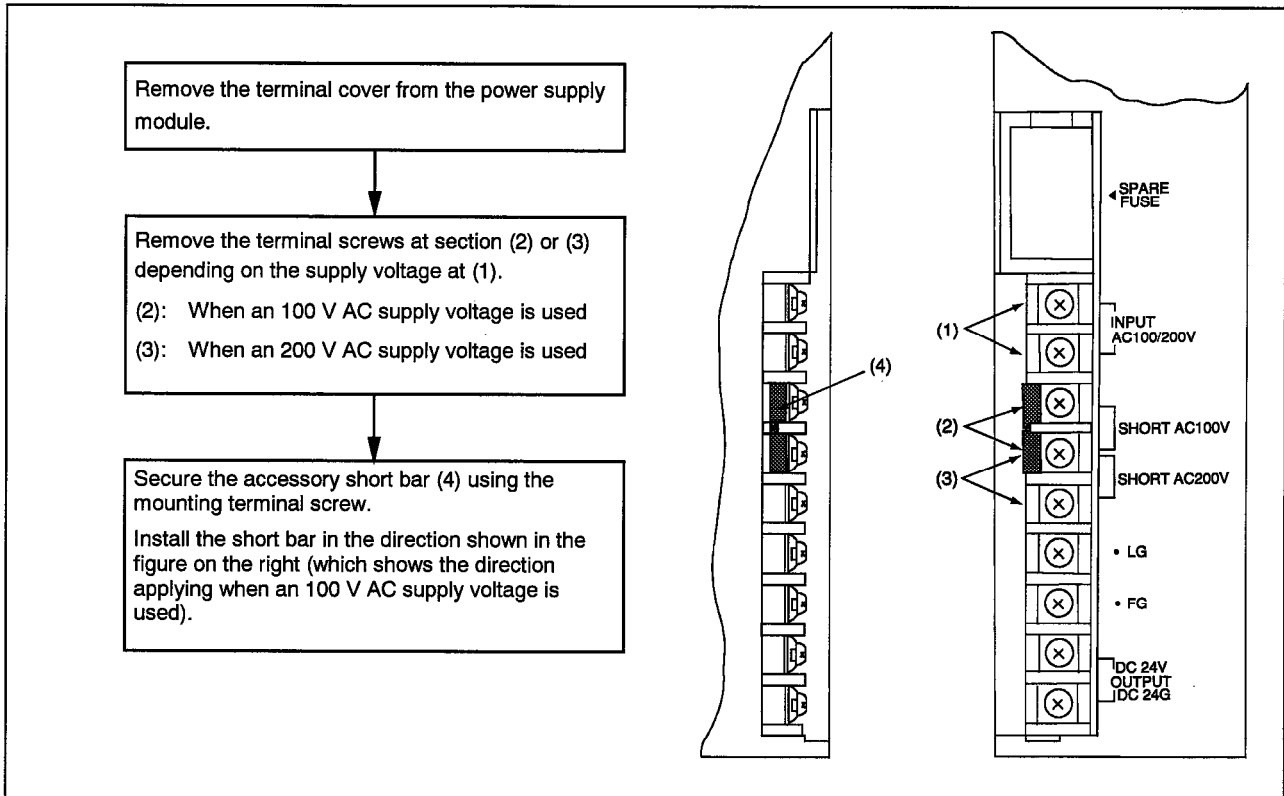

### CHECKPOINTS

- (1) Do not set the supply voltage incorrectly since the following trouble will occur if the setting does not correspond to the supply voltage.

	Supply voltage	
	100 V AC	200 V AC
Set to 100 V AC (short bar mounted at (2))	—	Destruction of power supply module (CPU remains trouble-free)
Set to 200 V AC (short bar mounted at (3))	No trouble in module but CPU fails to operate	—
No setting (short bar is not mounted)	No trouble in module but CPU fails to operate	

# 6 BASE UNIT AND EXTENSION CABLES

## 6.1 Specifications

Described below are the specifications of the extension base units and extension cables which can be used with the system.

### 6.1.1 Specifications Table for Standard Type of Extension Base Unit

Item	Model name		
	A62B	A65B	A68B
I/O module installation capacity	2 units	5 units	8 units
Power supply module installation required	Yes		
Mounting hole size	6 mm dia. elongated hole (for M5 screws)		
Terminal screw size	—		
Compatible cable size	—		
Compatible solderless terminals	—		
Compatible tightening torque	—		
Dimensions (mm)	238 x 250 x 29	352 x 250 x 29	466 x 250 x 29
Weight (kg)	1.1	1.4	1.9
Accessories	—		

### 6.1.2 Specifications Table for Standard Type of Extension Cables

Item	Model name		
	AC06B	AC12B	AC30B
Cable length (m)	0.6	1.2	3
5 V DC supply line resistance ( $\Omega$ (at 55°C))	0.019	0.028	0.052
Applications	<ul style="list-style-type: none"> <li>• Connection between extension base unit and master base unit</li> <li>• Connection between extension base units</li> </ul>		
Weight (kg)	0.34	0.52	1.06



### Caution

- Connect the extension cables securely to the connectors on the master and extension base units. Check for liftoff after installation. Defective contact can cause input and/or output errors.

#### CHECKPOINTS

The A6SIMX64Y64 cannot be connected since no power can be supplied.

### 6.1.3 Specifications Table for Compact Type of Extension Base Unit

Item	Model name	
	A1S65B	A1S68B
I/O module installation capacity	5 units	8 units
Power supply module installation required	Yes	
Mounting hole size	6 mm dia. elongated hole (for M5 screws)	
Terminal screw size	—	—
Compatible cable size	—	—
Compatible solderless terminals	—	—
Dimensions (mm)	315 x 130 x 28	420 x 130 x 28
Weight (kg)	0.71	0.95
Accessories	M5 x 25 mounting screws x 4	

### 6.1.4 Specifications Table for Compact Type of Extension Cables

Table 6.3 gives the specifications of the extension cables which can be used with the A2USCPU system.

**Table 6.3 Extension cable specifications**

Item	Model name							
	A1SC01B	A1SC03B	A1SC07B	A1SC12B	A1SC30B	A1SC60B	A1SC05NB	A1SC07NB
Cable length (m)	0.055	0.33	0.7	1.2	3.0	6.0	0.45	0.7
DC 5 V supply line resistance ( $\Omega$ (at 55°C))	0.02	0.021	0.036	0.055	0.121	0.182	0.037	0.045
Applications	Connection between extension base unit and master base unit							
Weight (kg)	0.025	0.10	0.14	0.20	0.4	0.65	0.2	0.22

When an extension cable is used, do not run it near or bunch it with any of the main circuit (high-voltage, high-current) lines.

## 6.2 Handling Precautions

Described below are the precautions for handling the base unit from its removal from the packing carton to its installation.

- (1) Do not drop the base unit or subject it to strong impact since its terminal board connectors and pin connectors are made of plastic.



### Caution

- Do not remove the printed circuit boards from the base unit. Failure to heed this caution can result in trouble, malfunctioning, injury or a fire.
- Take care not to allow chips, scraps of wire or other foreign matter to enter the base unit. This can cause trouble, malfunctioning or a fire.

## 6.3 Names of Parts

Described below are the names of the parts of the extension base units .

(1) Standard type of extension base units (A62B, A65B, A68B)

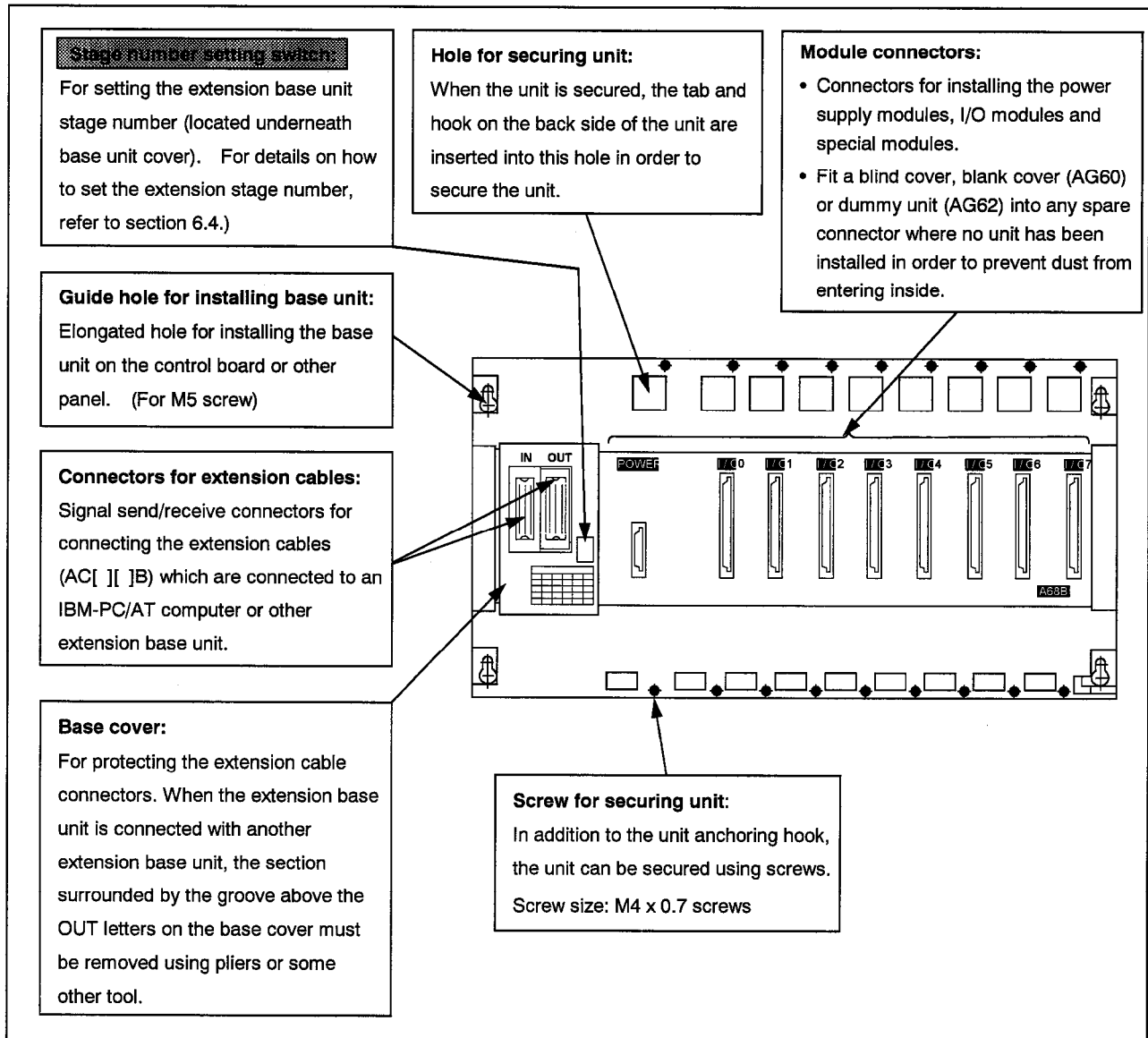

### REMARKS

Whatever is shaded ( ■ ) must be set before the base unit is installed and operation is commenced.



## 6. BASE UNIT AND EXTENSION CABLES

MELSEC-A

### (2) Compact type of extension base units

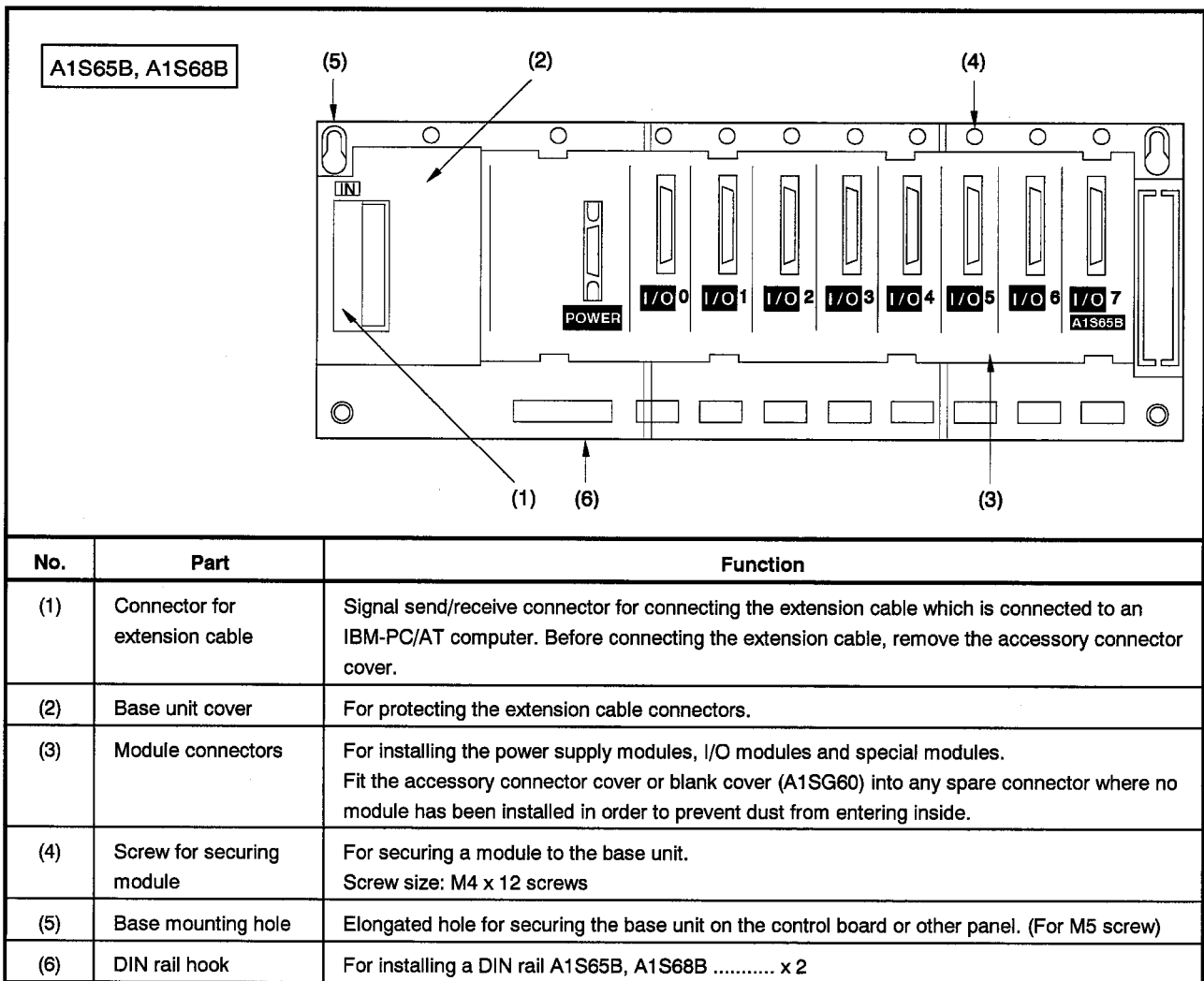

## 6.4 Setting the Extension Sage Number

Described below is the method used to set the stage number for each extension base unit when these extension units are used.

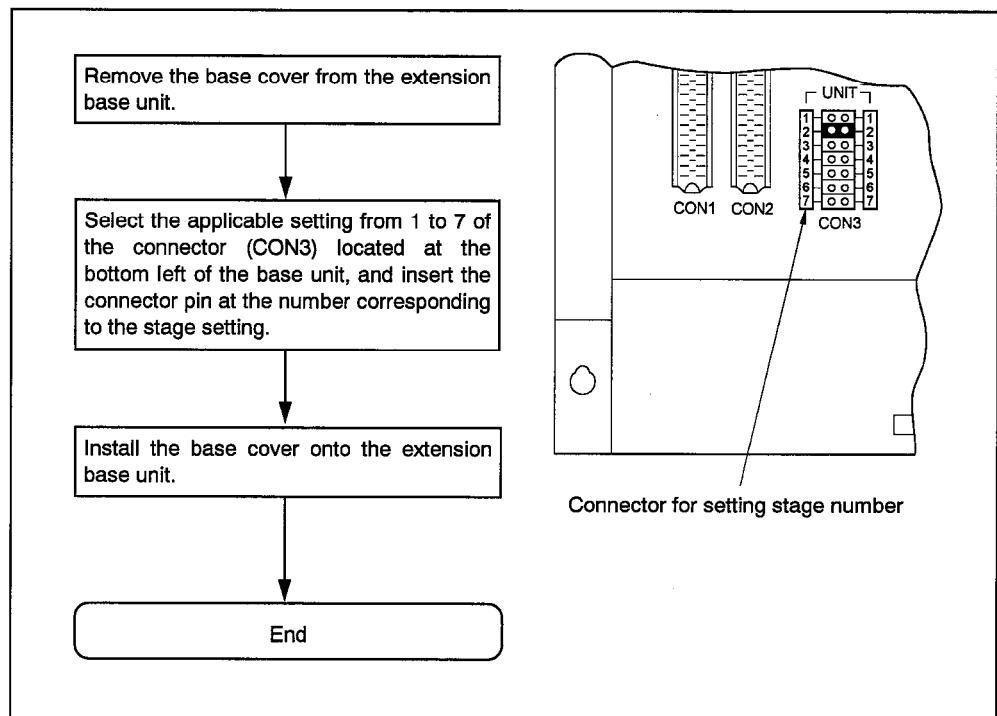

Settings for extension base unit stage number

	Settings for extension stage number						
	1st stage	2nd stage	3rd stage	4th stage	5th stage	6th stage	7th stage
Stage number connector setting	 CON3	 CON3	 CON3	 CON3	 CON3	 CON3	 CON3

### CHECKPOINT

Set the stage number setting connector (CON3) to a number from 1 to 7 which corresponds to the extension stage number. Do not set the unit at more than two stages, duplicate an existing stage number or fail to set the stage number. Otherwise, input and/or output errors will occur.

# 7 MOUNTING AND INSTALLATION

This chapter describes the mounting and installation procedures and provides some cautionary notes for improving the reliability of the system and giving full rein to its functions.

## 7.1 Failsafe Measure for Proper Operation when the Power is Turned On

When the sequencer power is turned on or off, the process output may temporarily fail to function properly due to the difference in the delay time and startup time between the power supply for the IBM-PC/AT computer and external power supply (DC, in particular) for the process.

For instance, when the power for the IBM-PC/AT computer is turned on after the external power supply for the process has been turned on at the DC output module, the DC output module may deliver an incorrect output for an instant when the power supply for the IBM-PC/AT computer is turned on. In this case, it is necessary to configure a circuit which enables the power supply for the IBM-PC/AT computer to be turned on first.

Fig. 5.1 shows the timing at which the external power supply for the process is turned on

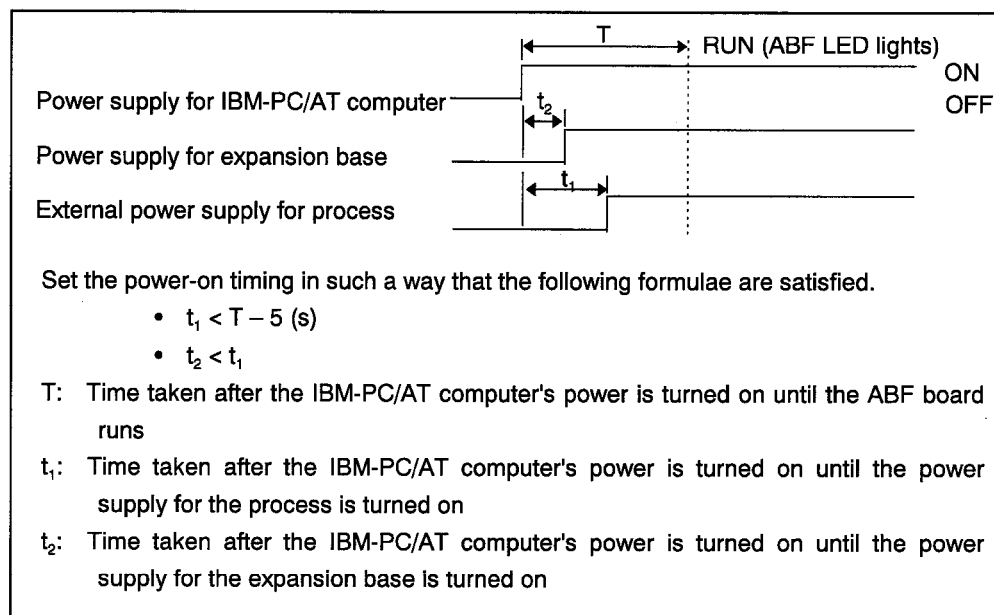

Fig. 7.1 Timing at which external power supply for process is turned on

## 7.2 Failsafe Measure for Output Module Failures

It may not be possible for the IBM-PC/AT computer to detect a failure which has occurred in the input/output control section.

In a case like this, all the indicators may light up or go off, and it may not be possible to ensure the proper operation or safety of the control target, depending on the nature of the failure concerned.

The manufacturer makes every possible effort to ensure the highest quality of its products. Nevertheless, an external failsafe circuit must be configured so that the machine is protected from damage and accidents in the event that the sequencer fails for some reason or other.

An example of a failsafe circuit is shown below.

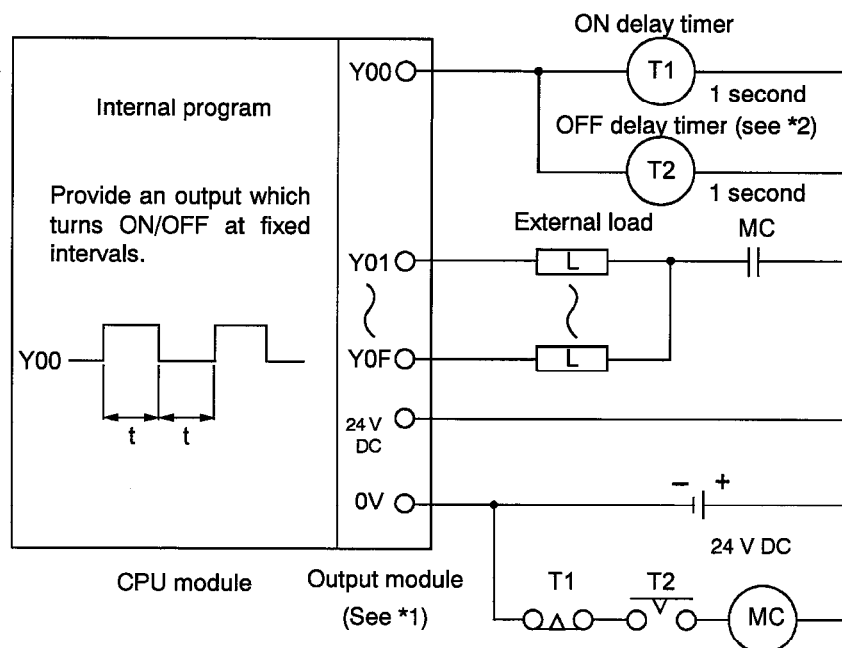

t: Set this to approximately double the program running time (1 scan).

(\*1) Since Y00 is repeatedly turned ON/OFF at intervals of t seconds, use a contactless output module (transistor in the above example).

(\*2) If it is hard to obtain an OFF delay timer (especially a miniature timer), use an ON delay timer such as the indicated on the next page to configure a failsafe circuit.

When configuring a failsafe circuit using ON delay timers only

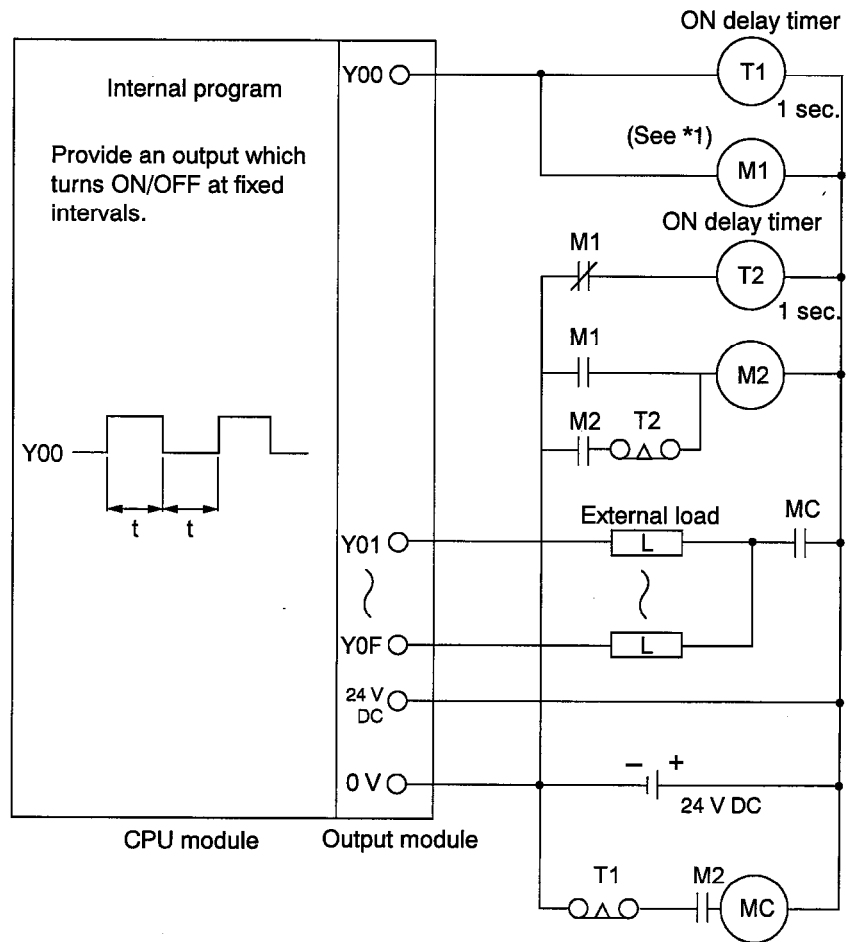

t: Set this to approximately double the program running time (1 scan).

(\*1) Use a solid-state relay for the M1 relay.

### 7.3 Installation Environment

---

Avoid installing the expansion base unit in the following kinds of environments.

- (1) Where the ambient temperature is outside the 0 to 55°C range
- (2) Where the ambient humidity is outside the 10 to 90% RH range
- (3) Where sudden changes in the temperature may cause condensation to be formed
- (4) Where corrosive or inflammable gases are present
- (5) Where high concentrations of dust, iron powder or other conductive powders, oil mist, salt particles or organic solvents are present
- (6) Where the sequencer is exposed to direct sunlight
- (7) Where strong electrical or magnetic fields are generated
- (8) Where vibration or impact may be transmitted to the sequencer directly

### **7.4 Expansion Base Unit Installation**

This item describes how to install the expansion base unit, and it provides some cautionary notes.

#### **7.4.1 Cautionary Notes on Installation**

This item provides some cautionary notes to be heeded when the expansion base unit is to be installed in a board, etc.

- (1) In order to ensure adequate ventilation and facilitate the replacement of the unit, provide the following clearances between the top of the unit and the structures or parts.
  - A series: At least 80 mm (3.15 inch)
  - AnS series: At least 30 mm (1.18 inch)
- (2) Do not use the unit installed perpendicularly or horizontally as doing so causes poor ventilation.
- (3) Install the expansion base unit on a flat and level surface. An uneven or warped installation surface can strain the printed circuit board and cause trouble.
- (4) Avoid locations for installing the unit near a large electromagnetic contactor, no-fuse breaker or other source of vibration: use a separate panel or install it at a distance from such sources.
- (5) Provide a wiring duct where necessary.

Take the following points into consideration if the clearance dimensions above and below the sequencer will be less than those shown in Fig. 7.2.

  - (a) When the unit is to be installed above the sequencer, make the duct height less than 50 mm (2 inch) in order to ensure adequate ventilation.

Leave enough clearance above the sequencer to untighten and remove the mounting screws on the top of the unit.

It will not be possible to replace the unit unless the mounting screws on the top of the unit can be removed.
  - (b) When the unit is to be installed below the sequencer, leave enough clearance to safeguard the 100 V AC/200 V AC input lines of the power supply module and input and 12/24 V DC lines of the Input/Output module from any adverse effects.
- (6) In order to avoid the effects of radiation noise and heat, leave a clearance of at least 100 mm (3.9 inch) when any apparatus has been positioned in front of the sequencer (when any apparatus has been installed on the other side of the door). Furthermore, leave a clearance of at least 50 mm (2 inch) between the left and right sides of the base unit and the apparatus.

## 7.4.2 Installation Positions of Expansion Base Unit

This item describes the installation positions of the expansion base unit.

For the installation positions in the IBM-PC/AT computer, refer to the cautionary notes provided for the computer concerned.

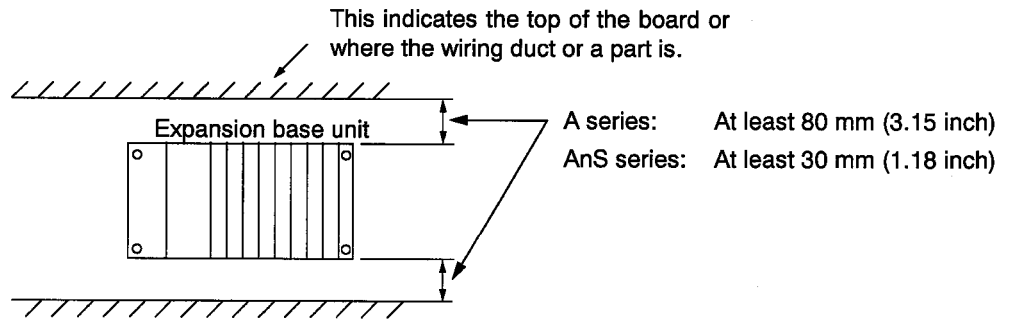

Fig. 7.2 Installation of expansion base unit

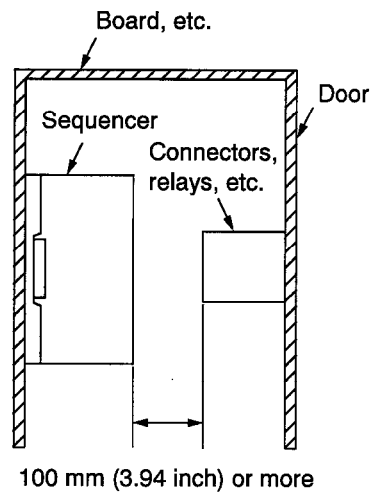

Fig. 7.3 Clearances with apparatus in front of the sequencer

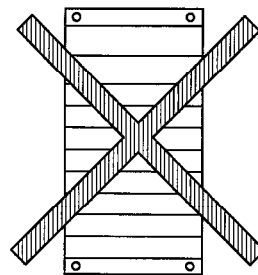

Fig. 7.4 Perpendicular installation (prohibited)

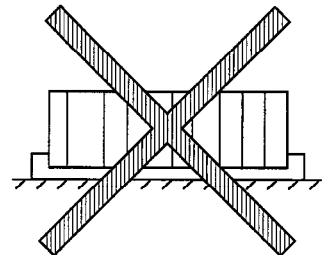

Fig. 7.5 Horizontal installation (prohibited)



### 7.5 Module Installation and Removal

---

This item describes the procedures for installing the power supply module, CPU module, Input/Output module, special module, etc. onto the base unit and removing them from the base unit.



#### **Danger**

- Before proceeding with installation, wiring work, etc., be absolutely sure to shut down at the external sources all the power for all the phases concerned.  
Failure to do so may cause electric shocks or damage the product.
- After having installed the units and connected the wires, be absolutely sure to attach the connector cover provided with the product before turning on the power or performing operations.  
Failure to attach the connector cover may lead to electric shocks.

(1) Module installation.

The procedure for installing a module is described below.

(a) A series

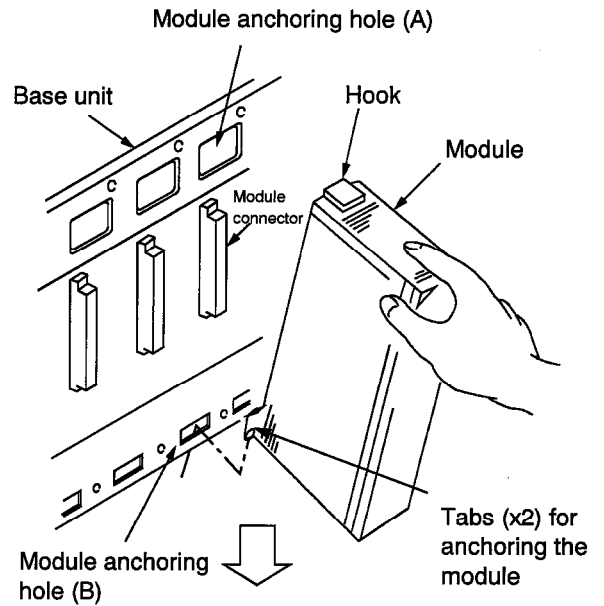
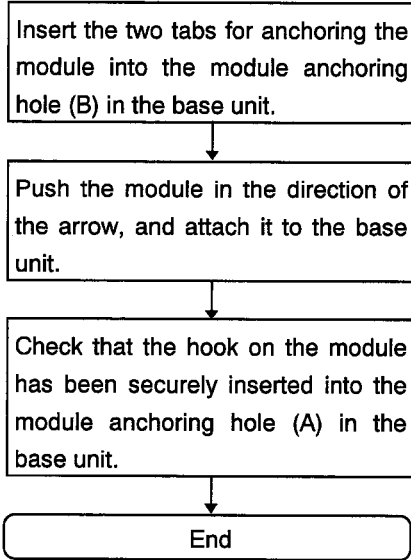

(b) AnS series

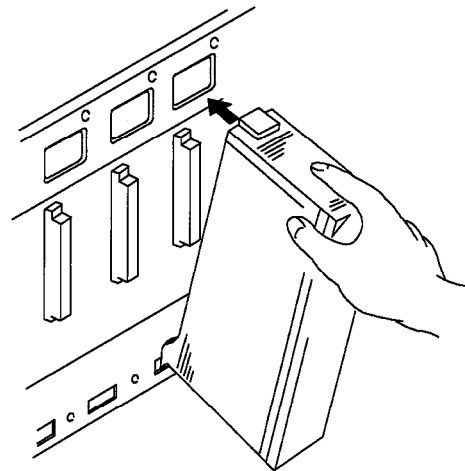
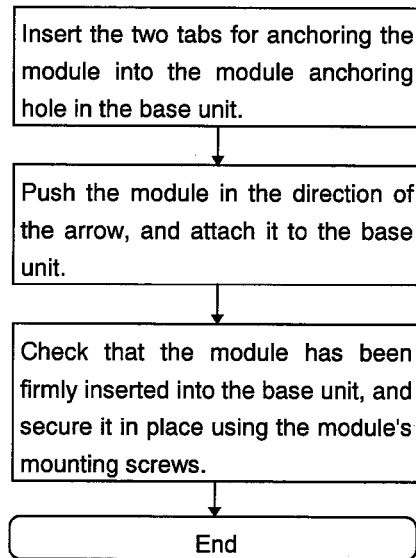

### CHECKPOINTS

(1) To secure the module, the tabs for anchoring the module must be inserted into the module anchoring hole (B). Forcing the module into place in order to secure it without inserting the tabs may bend the module connector pins or damage the module.

[Only when A series is used]

Screw the module into the base when it is to be used in a location subject to major vibration or impact. The user should provide M4 x 0.7 x 12 screws for this purpose. Refer to the figure on the right for installation.

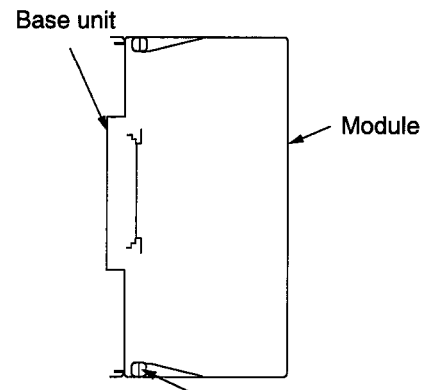

Screw for securing module  
(M4 x 0.7 x 12 screw)  
(Used only with the A series)

### **Caution**

- Insert the tabs for anchoring the module provided at the bottom of the module securely into the base unit anchoring hole first, and then install. Incorrect operation or malfunctioning may occur or the module may fall off if the module is not installed properly.

(2) Removing the module

The procedure for removing a module is described below.

(a) A series

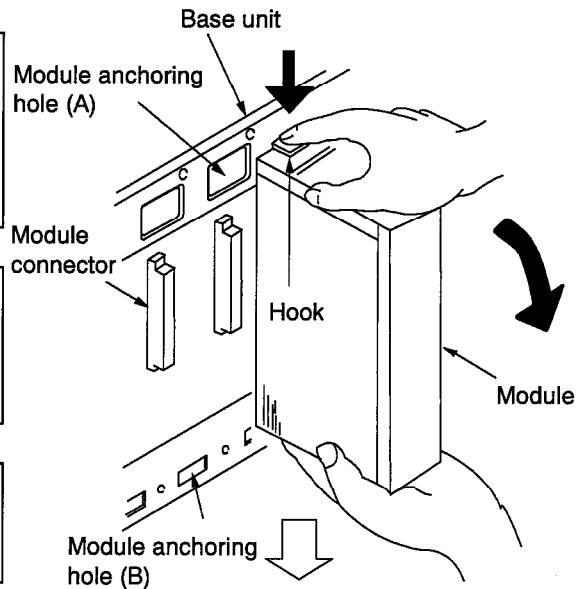
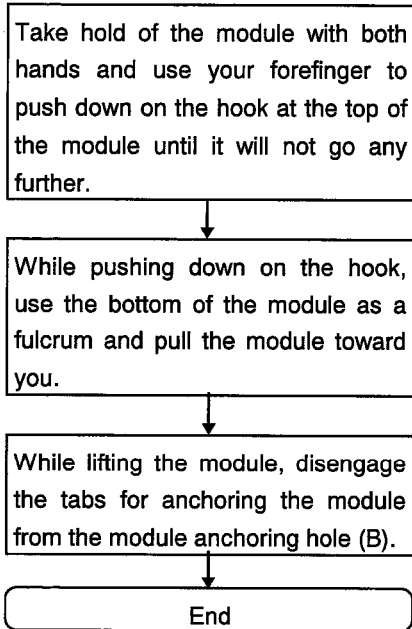

(b) AnS series

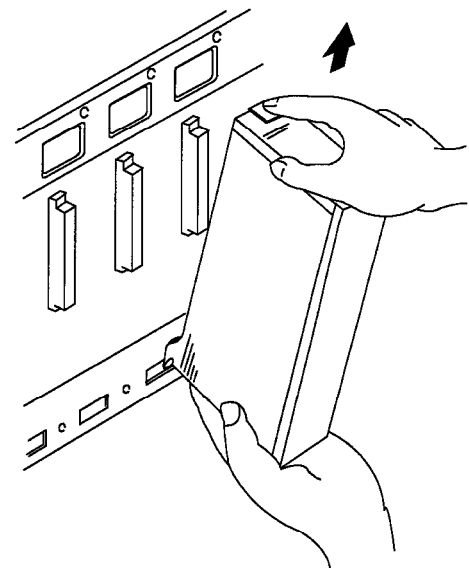
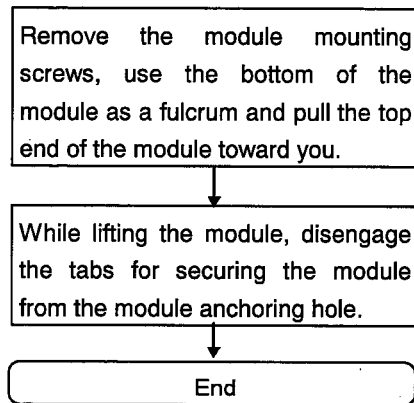

CHECKPOINTS

To remove the module, first the hook must be disengaged from the module anchoring hole (A), and then the tabs for securing the module must be disengaged from the module anchoring hole (B). Forcefully removing the module may damage the hook or tabs for securing the module.

### 7.6 Wiring

This item contains details concerning the wiring which the user should be familiar with to use the system.



#### **Danger**

- Before proceeding with installation, wiring work, etc., be absolutely sure to shut down at the external sources all the power for all the phases concerned. Failure to do so may cause electric shocks or damage the product.
- Upon completion of the installation, wiring work, etc., be absolutely sure to attach the connector cover provided with the module before turning on the power or performing operations.  
Failure to attach the connector cover may lead to electric shocks.



#### **Caution**

- Before connecting the wires to the sequencer, check the product's rated voltage and connector layout.  
Connecting a supply voltage which is at variance with the rating or connecting the wires improperly may cause fires and malfunctioning.
- Tighten up the connector screws using the specific torque.  
Looseness of these screws may cause short-circuiting, fires and malfunctioning.
- Take care to keep chips, scraps of wire and other foreign matter away from the module.  
Failure to do so may cause fires, failures or malfunctioning.
- Pressure-bond, pressure-weld or solder properly the connectors for external connections using the specified tools.  
Refer to the User's Manual accompanying the input/output module for details on the pressure-bonding and pressure-welding tools.  
Imperfect connections may cause short-circuiting, fires and malfunctioning.

## 7.6.1 Wiring Precautions

This item describes the precautions to be heeded in connecting the power cable and input/output wires.

(1) Power supply wiring for the expansion base unit

- (a) Connect a constant-voltage transformer if the voltage fluctuations exceed the specified rating.

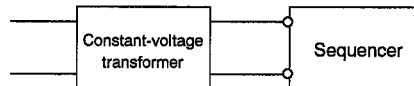

- (b) Ensure that the power supplied gives rise to minimal noise both between wires and between the equipment and ground. Connect an insulating transformer if the level of noise is high.

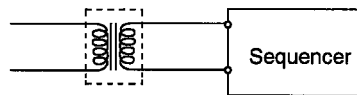

Insulating transformer

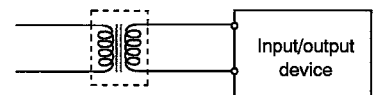

Insulating transformer

- (c) When using an insulating transformer or power transformer to reduce the voltage from 200 V AC to 100 V AC, select one whose capacity exceeds the values listed in the table below.

Power supply module model name	Transformer capacity
A61P (EU)	110 VA x n
A62P (EU)	110 VA x n
A65P	110 VA x n
A66P	95 VA x n
AIS61P	105 VA x n
AIS62P	105 VA x n

n: This indicates the number of power supply modules used.

- (d) When connecting the wires, separate the wires used for the sequencer power supply from those used for the input/output devices and power equipment, as shown in the figures below.

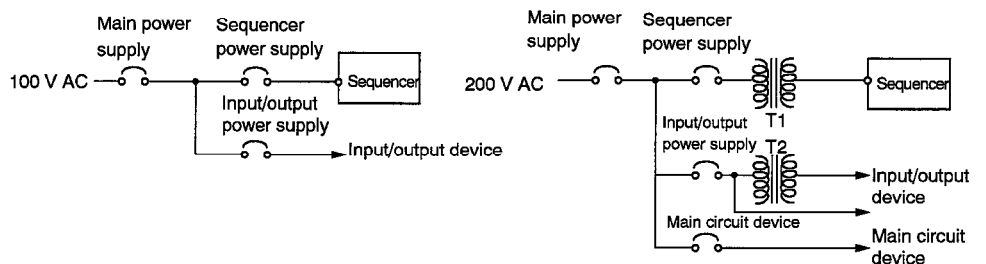

REMARKS
To ensure safety, provide each module or device with a dedicated switch for the power supply wiring if the module or device concerned falls into the category of devices whose "input/output modules are replaced while on-line."

- (e) Precaution for using 24 V DC output of power supply module models A62P, A65P, A66P and A1S62P  
Do not connect the 24 V DC outputs of a multiple number of power supply modules in parallel and supply them to a single input/output module. Parallel connection can damage the power supply modules. When one power supply module is not enough to provide the 24 V DC output capacity, supply the voltage from an external DC 24 V power supply.



**Caution** ● Do not connect the outputs of a multiple number of power supply modules in parallel. Failure to heed this caution may cause the power supply modules to heat up or result in fires or malfunctioning.

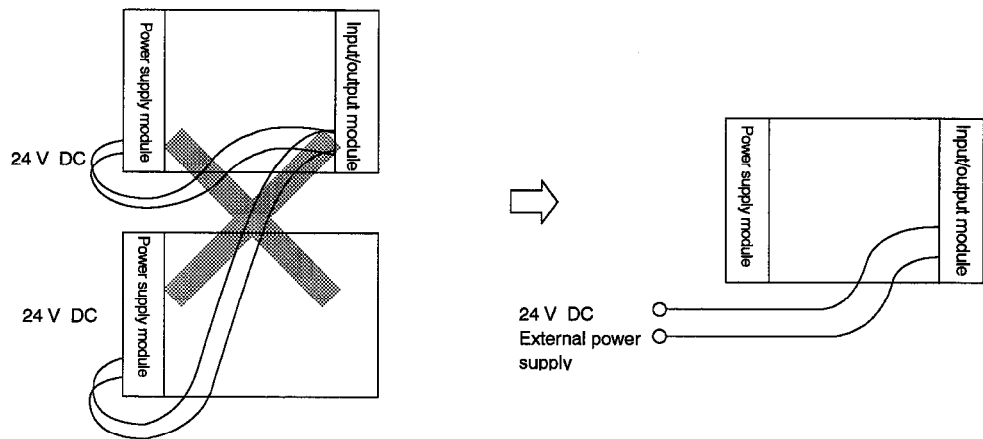

- (f) Twist the 100 V AC, 200 V AC and 24 V DC cables as tightly as possible, and make the connections between the modules as short as possible.
- (g) Use cables of the maximum thickness if possible (max. 2 mm<sup>2</sup>) for the 100 V AC, 200 V AC and 24 V DC cables so as to minimize reductions in the voltage.
- (h) Do not bundle the 100 V AC, 200 V AC and 24 V DC cables together with the main circuit (high voltage, high current) cables or input/output signal wires, and do not run them in the vicinity of such. If possible, maintain a distance of at least 100 mm (3.94 inch) between them.
- (i) To safeguard against surges triggered by lightning, connect a lightning surge absorber, as shown in the figure below.

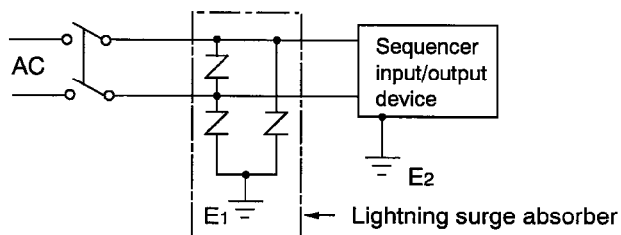

## CHECKPOINTS

- (1) Connect the lightning surge absorber ground ( $E_1$ ) and sequencer ground ( $E_2$ ) separately.
- (2) Select a lightning surge absorber which ensures that its maximum allowable circuit voltage will not be exceeded even when the supply voltage rises to its maximum level.

## (2) Input/output device wiring

**Caution**

- Do not bundle the control and communication cables together with the main circuit cables or power cables, and do not run them in the vicinity of such. As a general guideline, maintain a distance of at least 100 mm (3.94 inch) between them. Otherwise, noise may result causing malfunctioning.

- (a) The cable which can be connected to the terminal board connectors ranges from 0.75 to 2 mm<sup>2</sup> in size. However, a 0.75 mm<sup>2</sup> cable is recommended since it is easier to handle.
- (b) Choose separate wiring routes for the input wires and output wires.
- (c) Lay the input/output signal wires at least 100 mm (3.94 inch) away from the high-voltage and high-current main circuit cables.
- (d) If the wires cannot be laid at a distance from the main circuit cables or power cables, use batch shielded cables and connect them to ground at the sequencer side. In some cases, connect them to ground at the opposite side.

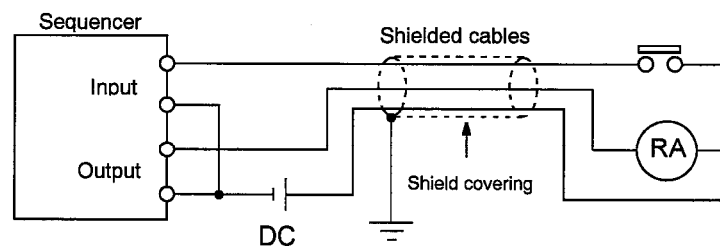

- (e) When pipes have been laid and wires connected, ensure that the pipes are properly grounded.
- (f) Run the 24 V DC input/output wires at a distance from the 100 V AC or 200 V AC cable.
- (g) When wires or cables are laid over distance in excess of 200 meters, current leakage stemming from the line capacity will give rise to trouble. Refer to the troubleshooting procedures in the User's Manual of the Input/Output module.



(3) Grounding



- The frame ground (FG) terminal must be connected straight to ground (type 3 grounding or above). Failure to do so may cause electric shocks and improper operation.

The grounding of the IBM-PC/AT computer is illustrated below.

- (a) Use the dedicated ground inside the same board or use the common ground. Type 3 grounding applies (ground resistance: less than 100 Ω).

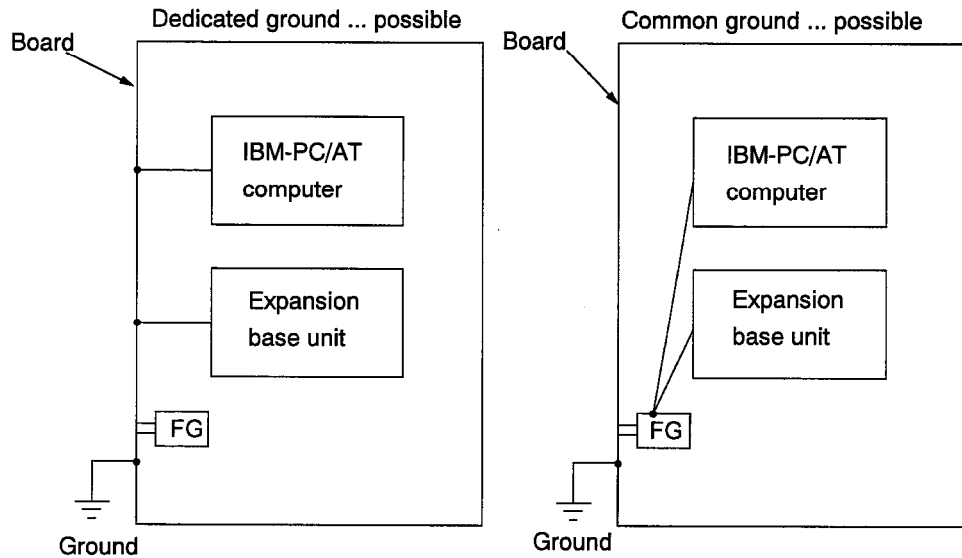

- (b) The table below indicates the cases in which the IBM-PC/AT computer can or cannot be used.

	IBM-PC/AT computer	Outlet	Can/cannot be used
FG terminal	Yes	Yes	Yes
	Yes	No	Yes
	No	Yes	Yes
	No	No	No

FG terminal: Yes = provided;  
No = not provided

## 7.7 Wiring Connections to Module Terminals

This item gives an example of the connection of the power cable and grounding wire to the expansion base.

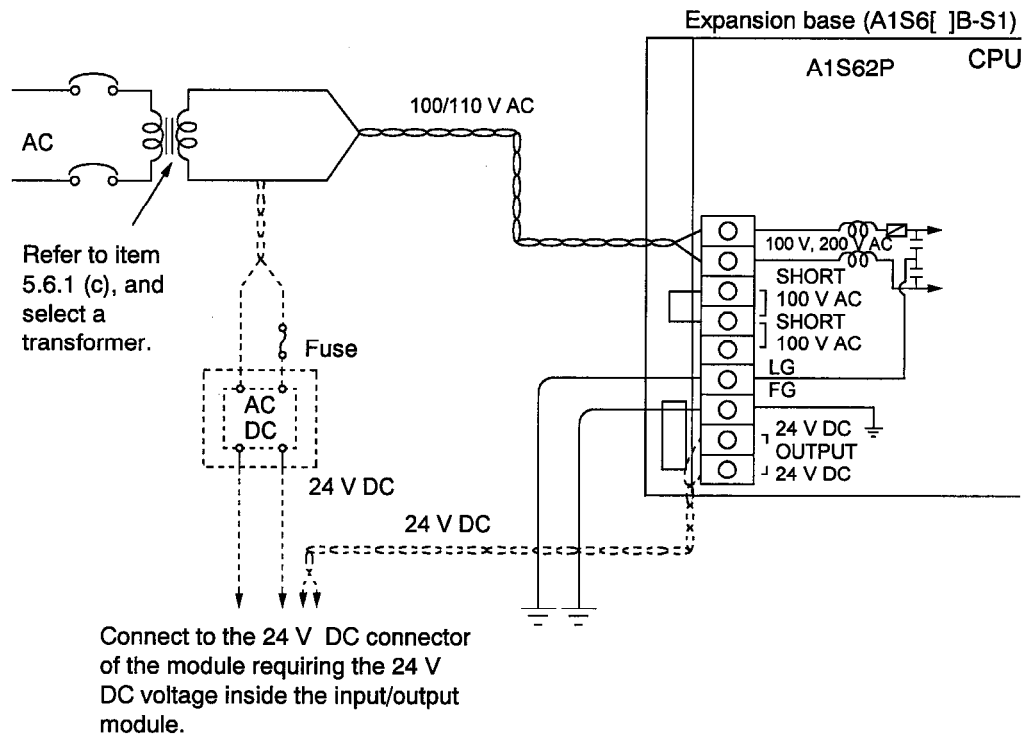

[ ] This indicates an arbitrary character string.

### CHECKPOINTS

- (1) Use cables of the maximum thickness if possible (max. 2 mm<sup>2</sup>) for the 100 V AC, 200 V AC and 24 V DC cables, and be absolutely sure to twist them from the lead-in terminal. If solderless terminals are provided, use solderless terminals provided with insulating sleeves in order to prevent short-circuiting caused by looseness in the screws.
- (2) When the LG terminal and FG terminal have been connected, these terminals must be connected to ground. Do not connect them if they are not connected to ground. Susceptibility to noise will increase if the LG and FG terminals have been connected but not grounded. The LG terminal has one-half of the potential of the input voltage so that an electric shock may be received if the terminal area is touched.
- (3) It is recommended that a noise-limiting transformer, line filter or other such part be attached externally.

## 7.8 Error Output Terminal Connection Method

This item describes how to connect the error output terminals.

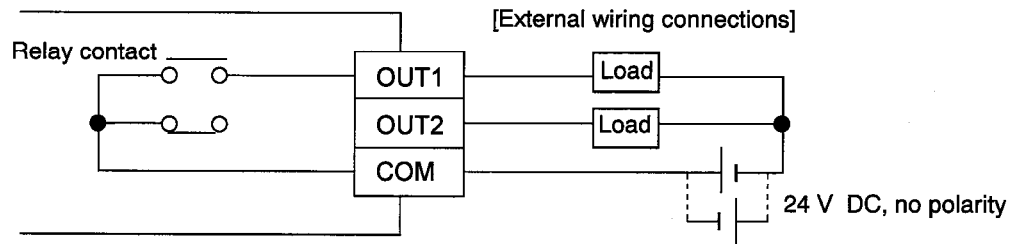

- (1) OUT1: Set ON (shorted) when an error is detected.
- (2) OUT2: Set OFF (open) when an error is detected.



[Output specifications]

Item	Specification	Remarks
Output configuration	OUT1: Normally open contact	—
	OUT2: Normally closed contact	A normally closed contact is recommended to ensure safety.
Rated voltage	24 V DC	—
Maximum allowable current	1.0 A	—
Maximum applicable load	1 mA	10 mV DC

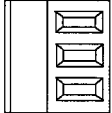
[Error output terminal specifications]

Error output terminal	Item	Specification
	Applicable wire size	0.13 to 2.5 mm <sup>2</sup>
	Terminal screw tightening torque	0.4 Nm
	Wire peeling length	Use with 7 mm of wire coating removed  7 mm

### **7.9 Precautions for Connection with Uninterruptible Power System**

---

The following points should be borne in mind when the power supply modules on the expansion base are to be connected with an uninterruptible power system (UPS).

Use a normal inverter power supply type of UPS with a voltage distortion rate of less than 5%.  
Do not use a normal commercial power supply type of UPS.

## 8 DRIVER INSTALLATION, DELETION

This chapter describes the installation and deletion of the drivers for operating the ABF board.

### 8.1 Installation/Deletion of Windows NT Driver

#### 8.1.1 Installation of Windows NT Driver

Follow the procedure below to install the Windows NT driver.

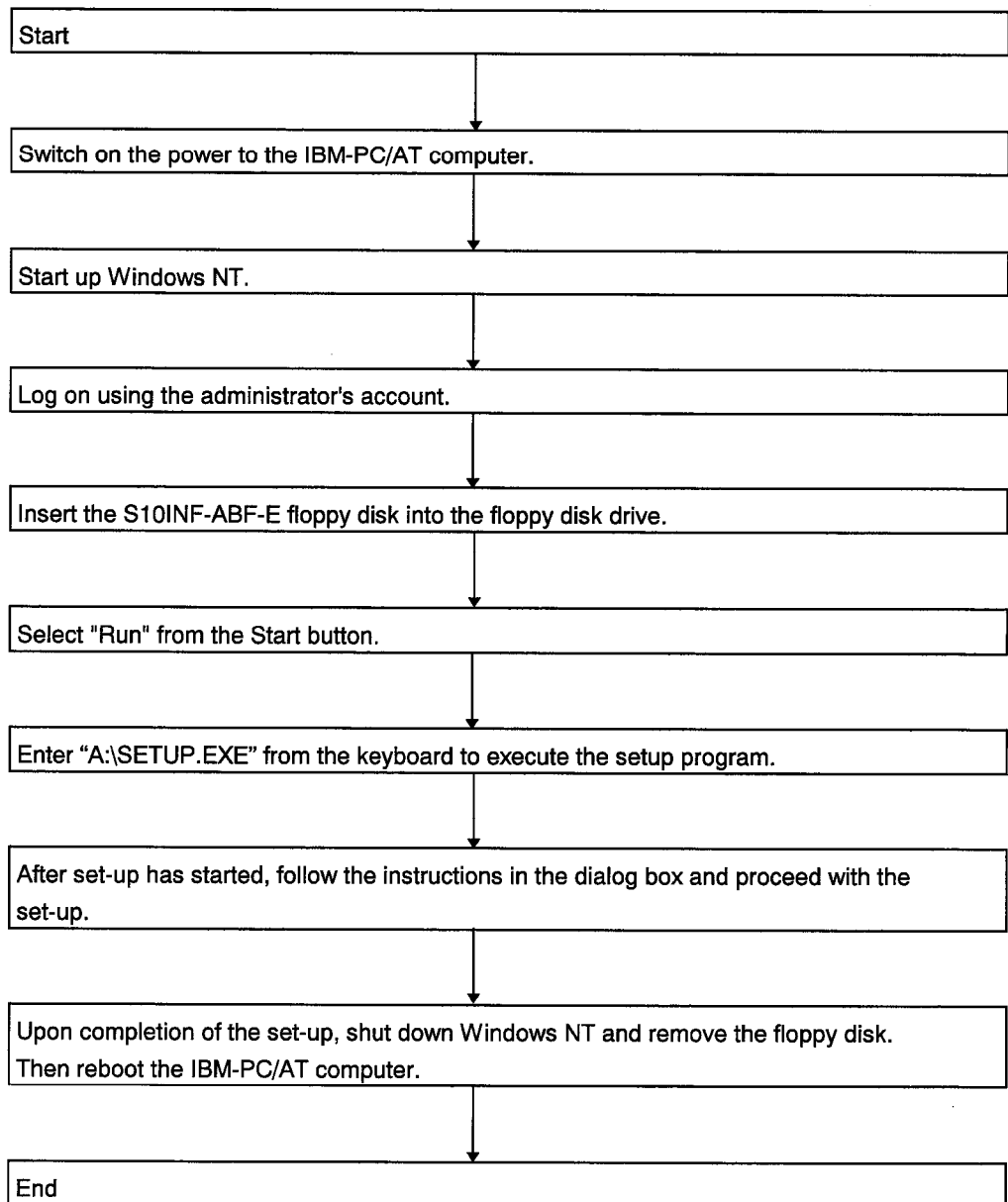

## 8.1.2 Directories Configuration After Installation

The Directories configuration after the Windows NT driver has been installed is shown below.

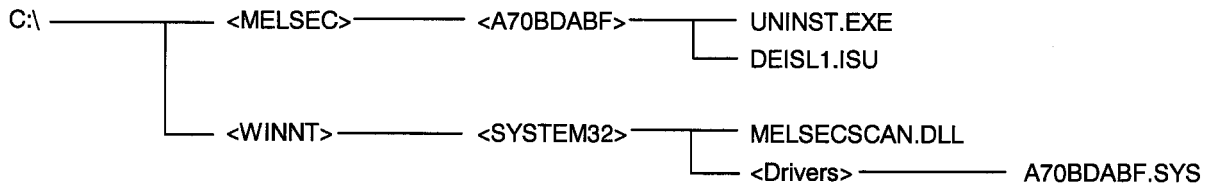

(\*1) About 700 free K bytes are required on the hard disk for installation.

(\*2) The driver is installed in the MELSEC directory as the default but the user may designate any directory for installation.

## 8.1.3 Deletion of Windows NT Driver

The steps for deleting the Windows NT driver are outlined below.

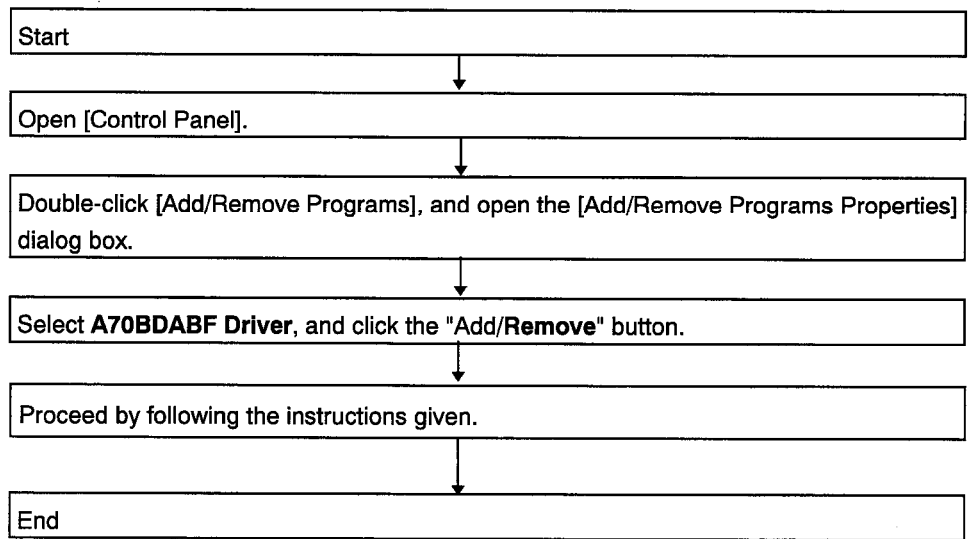

## 8.1.4 Windows NT Driver Status Change Procedure

The steps for changing the Windows NT driver status are outlined below.

Start

Select the setting from the Start button, and then select "Control Panel."

Double click on the "Device" icon on the "Control Panel." The dialog box shown below now appears.

Select A70BDABF on the dialog box.

Device	Status	Startup
A70BDABF	Started	Automatic
Abiosdsk	Disabled	Disabled
AFD Networking Support Environmer	Started	Automatic
Aha154x	Started	Boot
Aha174x	Disabled	Disabled
aic78xx	Disabled	Disabled
Always	Disabled	Disabled
amiOnt	Disabled	Disabled
amsint	Disabled	Disabled
Arrow	Disabled	Disabled

Click on the Start button to start; click on the Stop button to stop.

## 9 UTILITY

Described below are the operations and settings of the utility.

### 9.1 Start Method

The method of starting the utility is indicated below.

Select [Start] → [Programs] → [Melsec] from Windows NT 4.0, and click [A70BDABF Utility].



#### CHECKPOINTS

- The dedicated driver (A70BDABF) is required to start the ABF utility.
- When the dedicated driver (A70BDABF) has not been started up, switch to the dedicated driver, and reboot the IBM-PC/AT computer.
- When the ABF driver provided with SoftLogic has been started up, switch to the dedicated driver (A70BDABF).
- A multiple number of ABF utilities cannot be started.



**9.2 Table of Functions**

---

The functions of the utility are listed in the table below.

<b>Function</b>	<b>Description</b>	<b>Reference page</b>
INFORMATION	Displays the board status.	Section 9.4
DEVICE MONITOR	Monitors the bit devices and buffer memory.	Section 9.5
I/O LOCATION	Provides the I/O allocation.	Section 9.6
TEST	Tests whether the board status is normal.	Section 9.7
VERSION	Displays the version of the utility.	Section 9.8

9.3 Description of Buttons

The common buttons are described below.

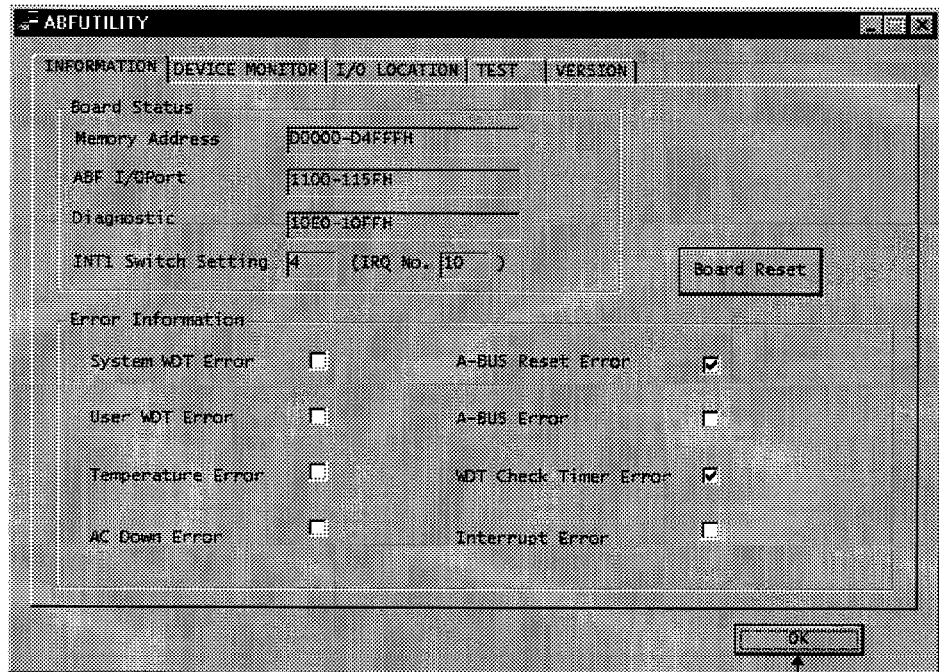

(1)  button

(1)

The ABF utility dialog screen appears when data has been changed on the I/O LOCATION screen. The ABF utility is exited if no changes have been made.

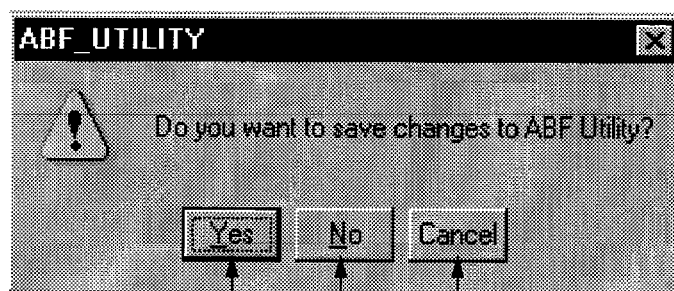

For displaying the ABF utility.  
 For exiting the ABF utility without saving the settings.  
 For saving the settings and exiting the ABF utility.

9.4 INFORMATION Screen Operations

This screen shows the board status.

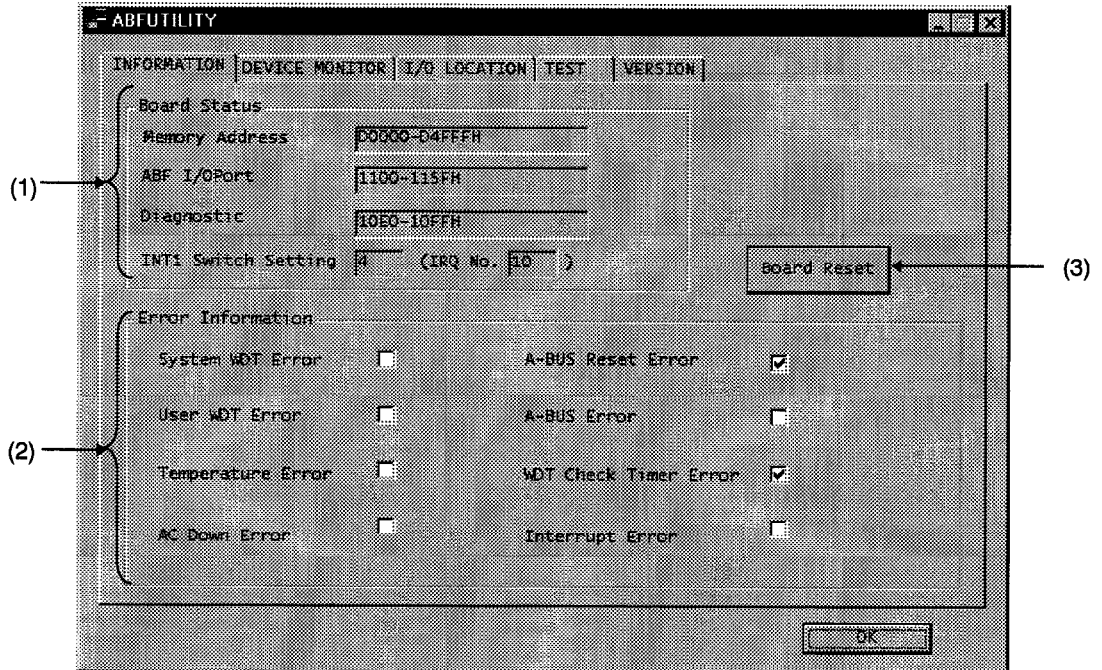

(1) Board Status

This indicates the board status.

- Memory Address:** Displays the range of the memory addresses occupied by the board.
- ABF I/O Port:** Displays the range of the I/O board addresses occupied by the board.
- Diagnostic:** Displays the range of the I/O board addresses occupied by Error Information.
- INT1 Switch Setting:** Displays the INT number corresponding to the IRQ number.
- IRQ No.:** Displays the IRQ number used by the board.

## (2) Error Information

This indicates the board error information (Normal: ; error: )

System WDT Error:	The operating system has run out of control, and the system WDT has started counting up. (The default setting of the system WDT is approximately 2 sec.)
User WDT Error:	The user WDT setting has been exceeded due to an out-of-control situation or processing has extended beyond the allotted time, and a time-out has occurred for the application program.
Temperature Error:	The temperature inside the IBM-PC/AT computer has exceeded the specified range.
AC Down Error:	The power supply unit has detected an instantaneous stop whose level is not sufficient to reset the hardware. (As the default, this error appears when an instantaneous stop has occurred for 5 or more times in a 2-second period.)
A-BUS Reset Error:	The power supply for the extension base unit is down.
A-BUS Error:	The A-bus has been in the wait status for more than 15 $\mu$ .
WDT Check Timer Error:	The WDT check timer has failed.
Interrupt Error:	An interrupt has occurred.

(3)  button

This displays the board reset dialog screen.

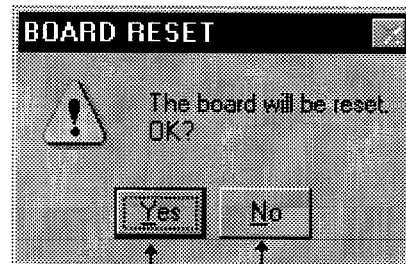

For canceling the updating of the displayed information.  
For resetting the displayed information and displaying the latest information.

## 9.5 DEVICE MONITOR Screen Operations

The bit devices and buffer memory are monitored on this screen.

### 9.5.1 Initial Screen

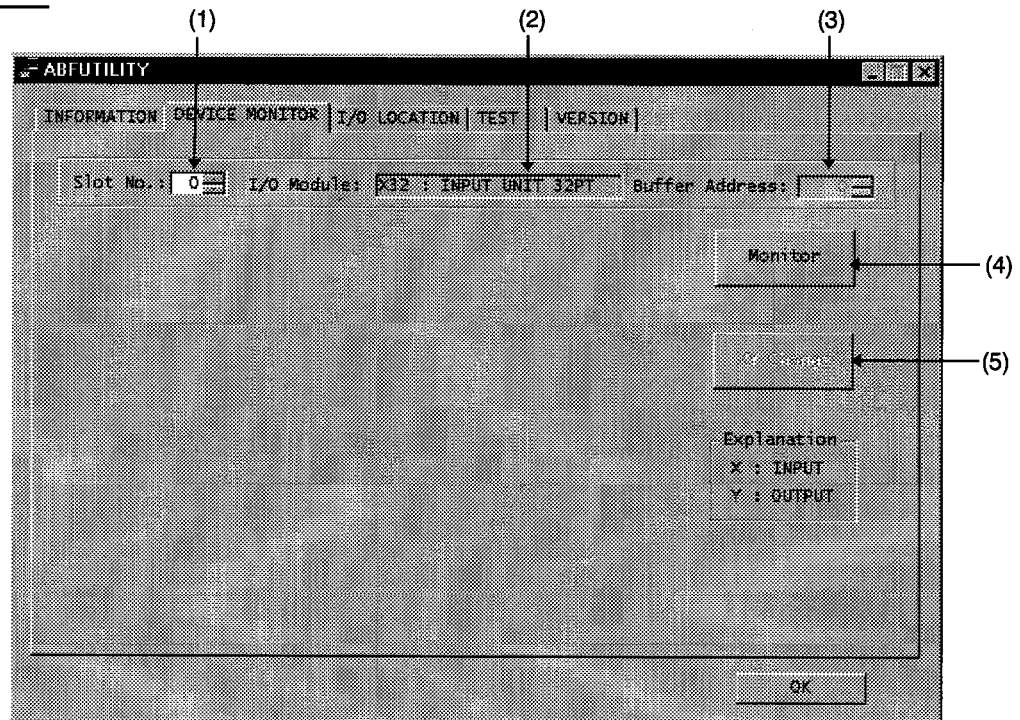

(1) Slot No.:

The number of the slot to be monitored is input here. (Any number from 0 to 55 can be selected.)

(2) I/O Module:

The I/O module data corresponding to Slot No. is displayed here. (It cannot be set)  
Refer to the I/O LOCATION screen operations in section 9.6 in this manual for details on settings.

(3) Buffer Address:

This is ignored on the initial screen.

(4) **Monitor** button:

This is used to switch to the bit device screen or buffer memory screen and start monitoring.

(5) **XY Change** button:

This is ignored on the initial screen.

#### CHECKPOINTS

- When I/O Module has been changed on the I/O LOCATION screen, the change will not be reflected on the DEVICE MONITOR screen unless the Board Reset button on the INFORMATION screen is clicked first.

## 9.5.2 Bit Device Screen

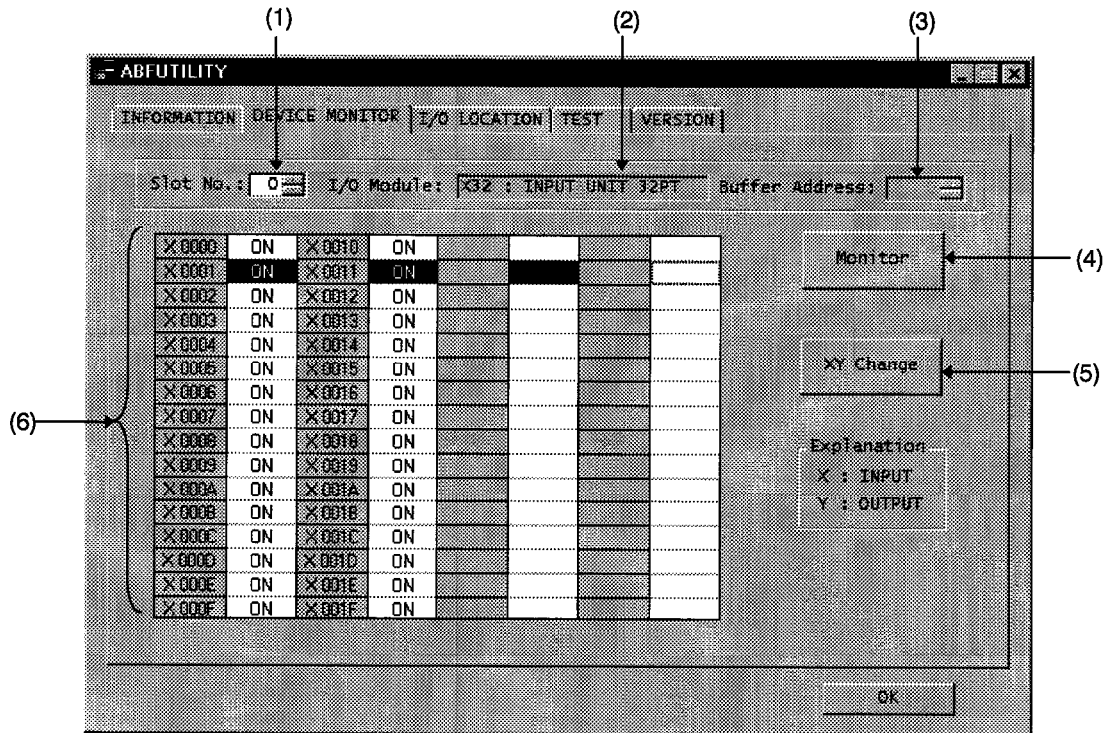

- (1) Slot No.:  
The number of the slot to be monitored is input here. (Any number from 0 to 55 can be selected.)
- (2) I/O Module:  
The I/O module data corresponding to Slot No. is displayed here. (It cannot be set)  
Refer to the I/O LOCATION screen operations in section 9.6 in this manual for details on settings.
- (3) Buffer Address:  
This is ignored on the bit device screen.

(4)  button:  
This is used to switch to the Bit Device screen or Buffer Memory screen and start monitoring.

(5)  button:  
This is used to change device type X or Y and display the type.

(6) Device information:

The statuses of the current devices for the module selected in Slot No. are displayed in these columns. To display other devices, make the selection in Slot No. and click the "Monitor" button.

Up to 64 points, can be displayed.

Data is displayed here (no display for OFF).

The device numbers are displayed here.

X 0000	ON	X 0010	ON				
X 0001	ON	X 0011	ON				
X 0002	ON	X 0012	ON				
X 0003	ON	X 0013	ON				
X 0004	ON	X 0014	ON				
X 0005	ON	X 0015	ON				
X 0006	ON	X 0016	ON				
X 0007	ON	X 0017	ON				
X 0008	ON	X 0018	ON				
X 0009	ON	X 0019	ON				
X 000A	ON	X 001A	ON				
X 000B	ON	X 001B	ON				
X 000C	ON	X 001C	ON				
X 000D	ON	X 001D	ON				
X 000E	ON	X 001E	ON				
X 000F	ON	X 001F	ON				

The cursor can be moved using the tab key.

The data can be set to ON or OFF by the space key or by double-clicking.

When the data is ON

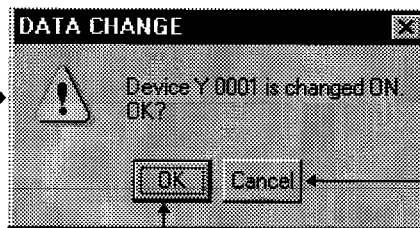

For canceling the data change to OFF.

For changing the data to OFF.

When the data is OFF

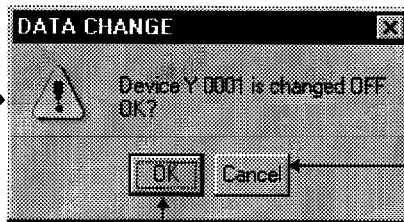

For canceling the data change to ON.

For changing the data to ON.

CHECKPOINTS

- Data for X device types cannot be changed.
- No display appears when the data is OFF.



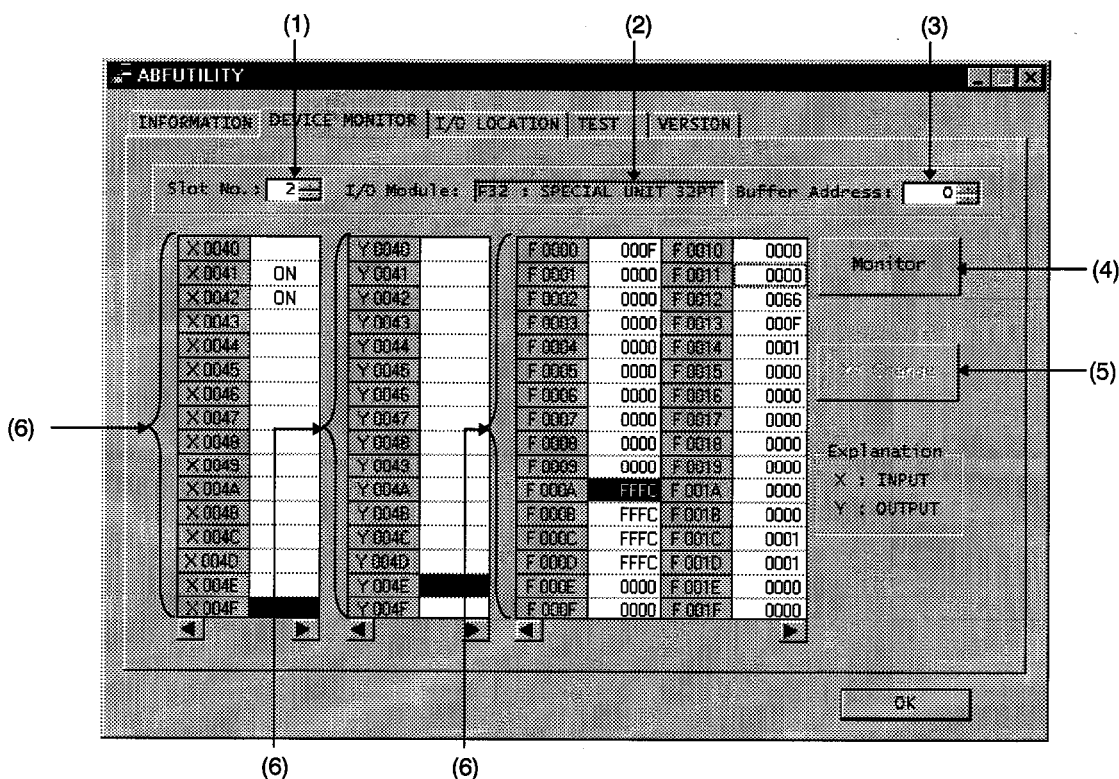

- To control the effect of the changes in the data on the sequencer while it is operating, stop SoftLogic so that the entire system will function on the safe side at all times.

9.5.3 Buffer Memory Screen



- (1) Slot No.:  
The number of the slot to be monitored is input here. (Any number from 0 to 55 can be selected.)
- (2) I/O Module:  
The I/O module data corresponding to Slot No. is displayed here. (It cannot be set)  
Refer to the I/O LOCATION screen operations in section 9.6 in this manual for details on settings.
- (3) Buffer Address:  
The buffer memory address is input here from 0 to 1FFFH in hexadecimal notation. (It is valid for special modules only.)

(4)  button:  
This is used to switch to the Bit Device screen or Buffer Memory screen and start monitoring.

(5)  button:  
This is ignored on the Buffer Memory screen.



(6) Device information:

The statuses of the current devices for the module selected in Slot No. are displayed in these columns.

To display other devices, make the selection in Slot No. and click the "Monitor" button.

Up to 64 points can be displayed by scrolling.

Data is displayed here (no display for OFF).

X.0040		Y.0040		F.0000	000F	F.0010	0000
X.0041	ON	Y.0041		F.0001	0000	F.0011	0000
X.0042	ON	Y.0042		F.0002	0000	F.0012	0000
X.0043		Y.0043		F.0003	0000	F.0013	000F
X.0044		Y.0044		F.0004	0000	F.0014	0001
X.0045		Y.0045		F.0005	0000	F.0015	0000
X.0046		Y.0046		F.0006	0000	F.0016	0000
X.0047		Y.0047		F.0007	0000	F.0017	0000
X.0048		Y.0048		F.0008	0000	F.0018	0000
X.0049		Y.0049		F.0009	0000	F.0019	0000
X.004A		Y.004A		F.000A	FFFF	F.001A	0000
X.004B		Y.004B		F.000B	FFFF	F.001B	0000
X.004C		Y.004C		F.000C	FFFF	F.001C	0001
X.004D		Y.004D		F.000D	FFFF	F.001D	0001
X.004E		Y.004E		F.000E	0000	F.001E	0000
X.004F		Y.004F		F.000F	0000	F.001F	0000

The device numbers are displayed here.

The data is displayed here.

The cursor can be moved using the tab key.

The data can be changed by the space key or by double-clicking.

With a Y device type  
 With an F device type (special module)

Refer to the bit device screen in section 9.5.2.

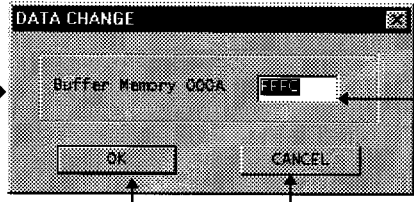

Input the data in hexadecimal notation.

For changing the data.

For canceling the changes in the data.



**Danger**

- To control the effect of the changes in the data on the sequencer while it is operating, stop SoftLogic so that the entire system will function on the safe side at all times.

9.6 I/O LOCATION Screen Operations

This screen is for I/O allocation.

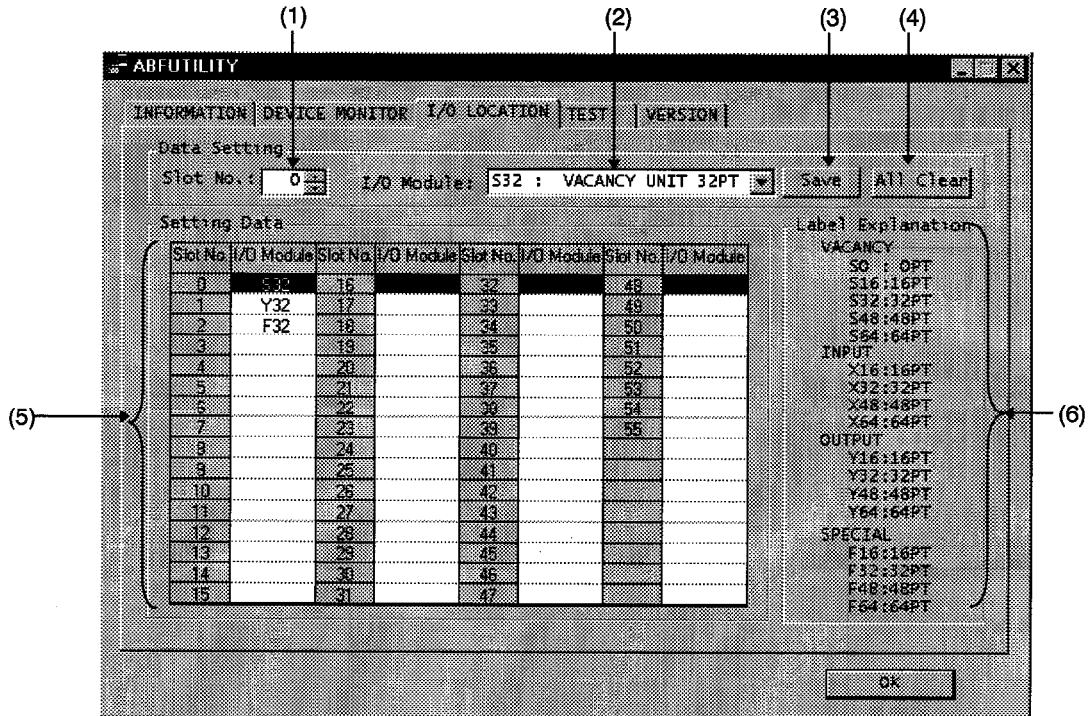

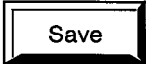
- (1) Slot No.:  
The number of the slot is set here. (Any number from 0 to 55 can be selected.)  
As soon as the number is set, the I/O Module data registered in the Setting Data column is displayed under I/O Module of the Data Setting columns.
- (2) I/O Module:  
The type of I/O module is selected from the combo box list.  
The contents of this list are identical to what is displayed in the Label Explanation column.  
Blanks are treated as cleared data.  
As soon as the type is set, the setting is reflected under I/O Module of the Setting Data columns.
- (3)  button:  
For displaying the SAVE dialog screen.

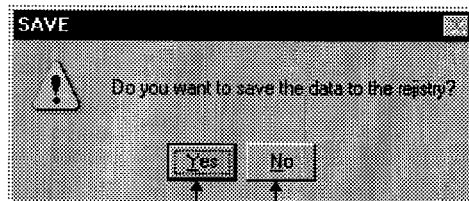

For canceling the saving of the data settings in the registry.  
For saving the data settings in the registry.

(4) **All Clear** button:

For displaying the ALL CLEAR dialog screen.

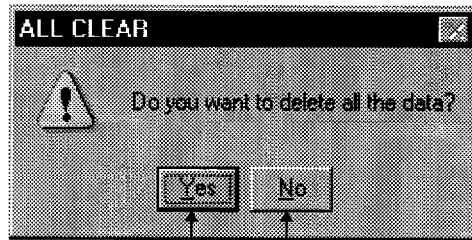

For canceling the deletion of all the I/O allocation data.

For deleting all the I/O allocation data.

(5) Setting Data

For displaying what was set in the Data Setting column.

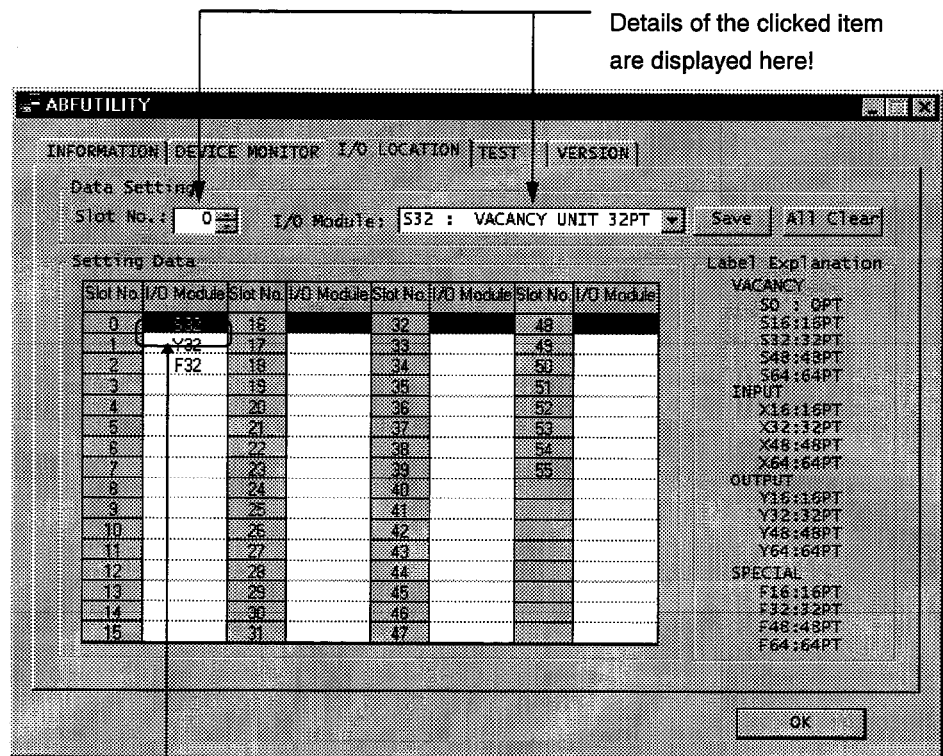

Click!

When the appropriate place in the Setting Data column is clicked, details of the clicked item are reflected in the Data Setting column.

(6) Label Explanation

The types of I/O modules are listed here.

<b>CHECKPOINTS</b>
<ul style="list-style-type: none"> <li>● Data is changed in the Data Setting column.</li> <li>● Only device types X, Y and F can be handled by the utility.</li> </ul>

9.7 TEST Screen Operations

This screen is for verifying whether the board status is normal.

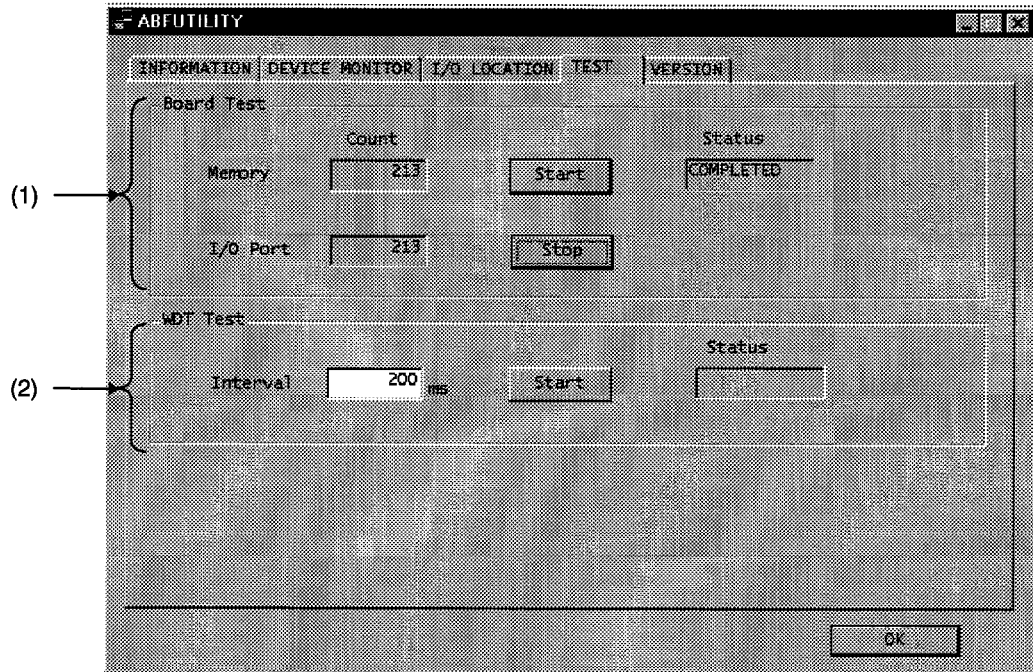

- (1) Board Test  
For testing the board status. (Refer to Board Test in section 9.7.1.)
- (2) WDT Test  
For testing the WDT status. (Refer to WDT Test in section 9.7.2.)

9.7.1 Board Test

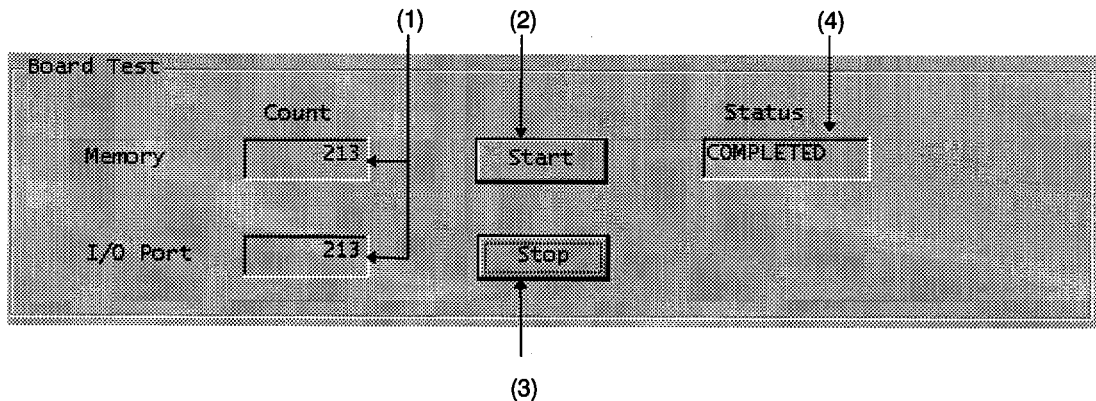

(1) Memory Count, I/O Port Count

When the "Start" button is clicked, write, read and compare are counted as 1 and they are added continuously from 0 to 65535 until the "Stop" button is clicked. (These counts cannot be input.)

(2)  button

For displaying the CAUTION dialog screen.

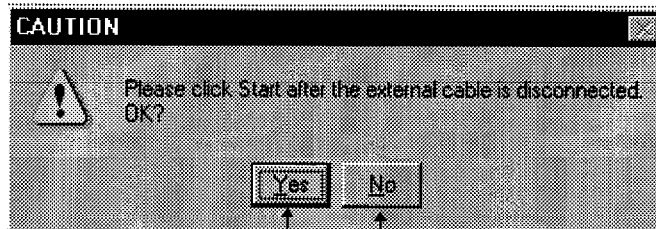

For canceling the start of the board test.

For disconnecting the external cable and starting the board test (write, read, compare) when the external cable has not been disconnected.

After the board test has commenced, all the buttons except the "Stop" button and the tab are no longer operable.

CHECKPOINTS
<ul style="list-style-type: none"> <li>● Disconnect the external cable before starting the board test.</li> <li>● Click the "Stop" button to stop the board test before changing the screen.</li> </ul>

- (3)  button

This terminates the board test (write, read, compare), and the board reset dialog screen appears.

Upon completion of the board test, operation is restored to all the buttons except the "Stop" button and the tab.

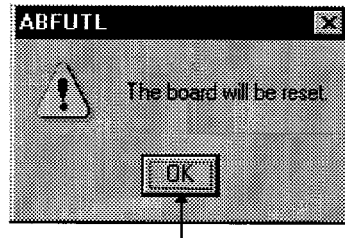

For clearing the data displayed on the TEST screen.

- (4) Status

For displaying the results of the board test (write, read, compare).

Details of the results are displayed as follows.

"RUN":	Now running
"COMPLETED":	OK
"ERROR":	NG
Blank:	Not conducted

When an error has occurred, the data compare error dialog screen appears.

[When a memory check error has occurred]

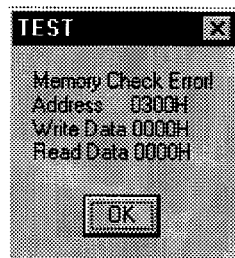

[When an I/O port check error has occurred]

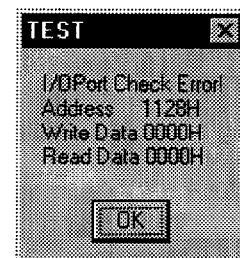

When the compared value differs from the test value, an error message appears and the compare operation is suspended.

### CHECKPOINTS

- Click the "Stop" button to stop the board test before changing the screen.

9.7.2 WDT Test

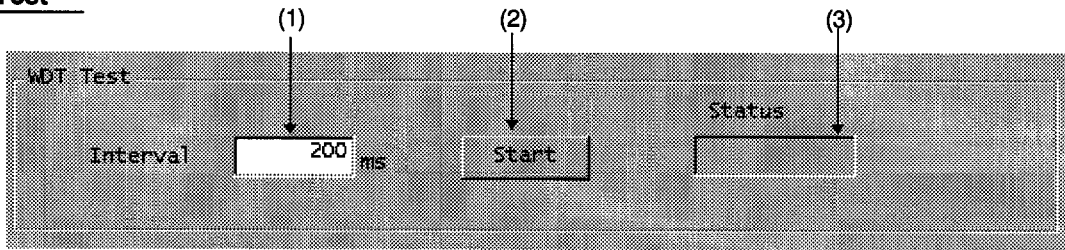

(1) Interval:

The WDT (watchdog timer) test interval is set in the 160 to 10240 ms range here. Input the interval using the figures 16 to 1024 since the input data is handled in 10 ms units. The default is 200 x 10ms.

(2)  button:

For displaying the board reset dialog screen and starting the WDT test.

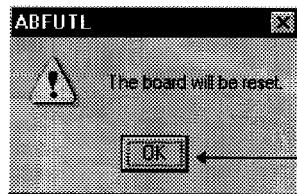

For clearing the data displayed on the TEST screen and starting the WDT test.

After the WDT test has commenced, all the buttons and the tab as well as Interval, etc. can no longer be controlled.

(3) Status:

For displaying the results of the WDT test. Details of the results are displayed as follows.

- "RUN": Now running
- "COMPLETED": OK
- "ERROR": NG
- Blank: Not conducted

As a result of the WDT test, the WDT CHECK dialog screen shown below appears.

[When the WDT is operating correctly]

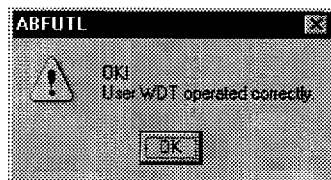

[When the WDT is operating abnormally]

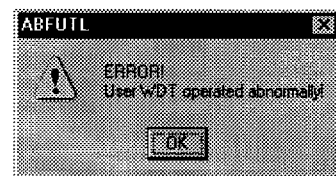

CHECKPOINTS

- All the data displayed on the TEST screen is cleared by clicking the "Board Reset" button on the INFORMATION screen. (Refer to the INFORMATION screen operations in Section 9.6.)

**9.8** VERSION Information

The utility version is displayed on this screen.

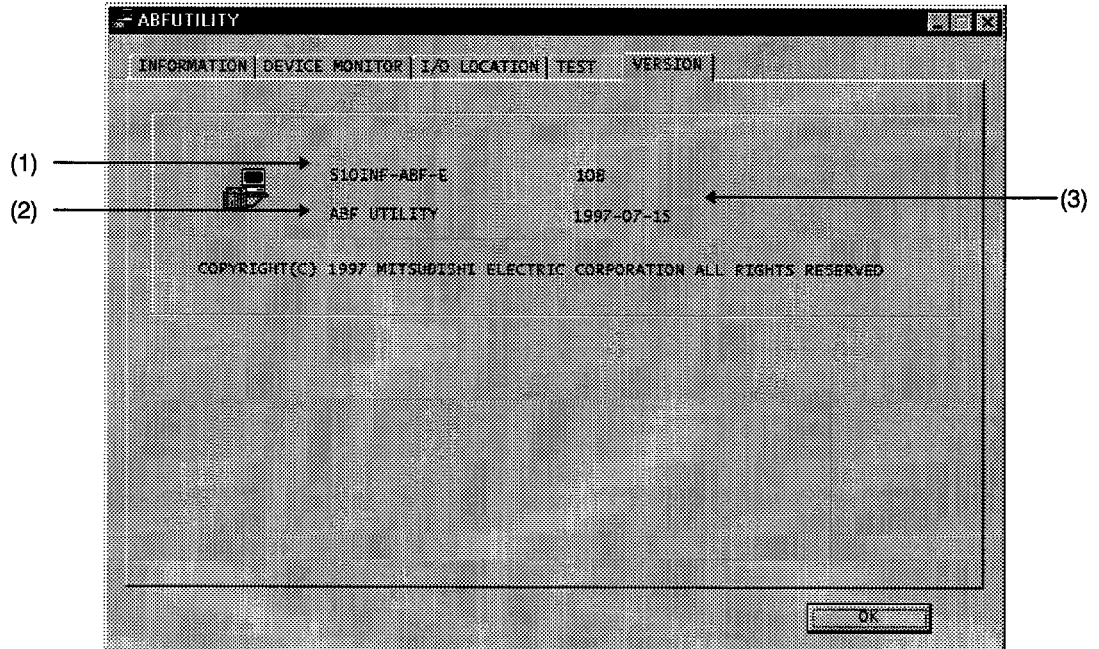

- (1) Model name:  
The model name of the utility is displayed here.
- (2) Product name:  
The product name of the utility is displayed here.
- (3) Version:  
The version of the utility is displayed here.



# 10 TROUBLESHOOTING

This chapter describes the various procedures for pinpointing the causes of various kinds of trouble which may occur during the construction of the system, and the suggested remedial action for rectifying the trouble.

## 10.1 Troubleshooting Tips

---

To start up the system quickly, there obviously should be as few incidences of trouble as possible but it is also important if trouble does occur that its cause be located as quickly as possible.

Two basic points are to be borne in mind when proceeding with troubleshooting.

(1) Visual checks

Check out the following points

- (a) Movements of the modules on the expansion base (stop, operating modes)
- (b) Power supply on/off status
- (c) Wiring connection status
- (d) LED display statuses

After checking out (a) to (d), connect the IBM-PC/AT computer to the external equipment, and check the operation of the user program.

(2) Narrowing down the possible cause of the trouble

On the basis of what has been ascertained in (1), figure out the general area where the trouble has occurred.

- (a) IBM-PC/AT computer side or expansion base unit side?
- (b) IBM-PC/AT computer itself or board?
- (c) Connecting cables?

## 10.2 Troubleshooting Flow

The nature of possible trouble is described by symptom.

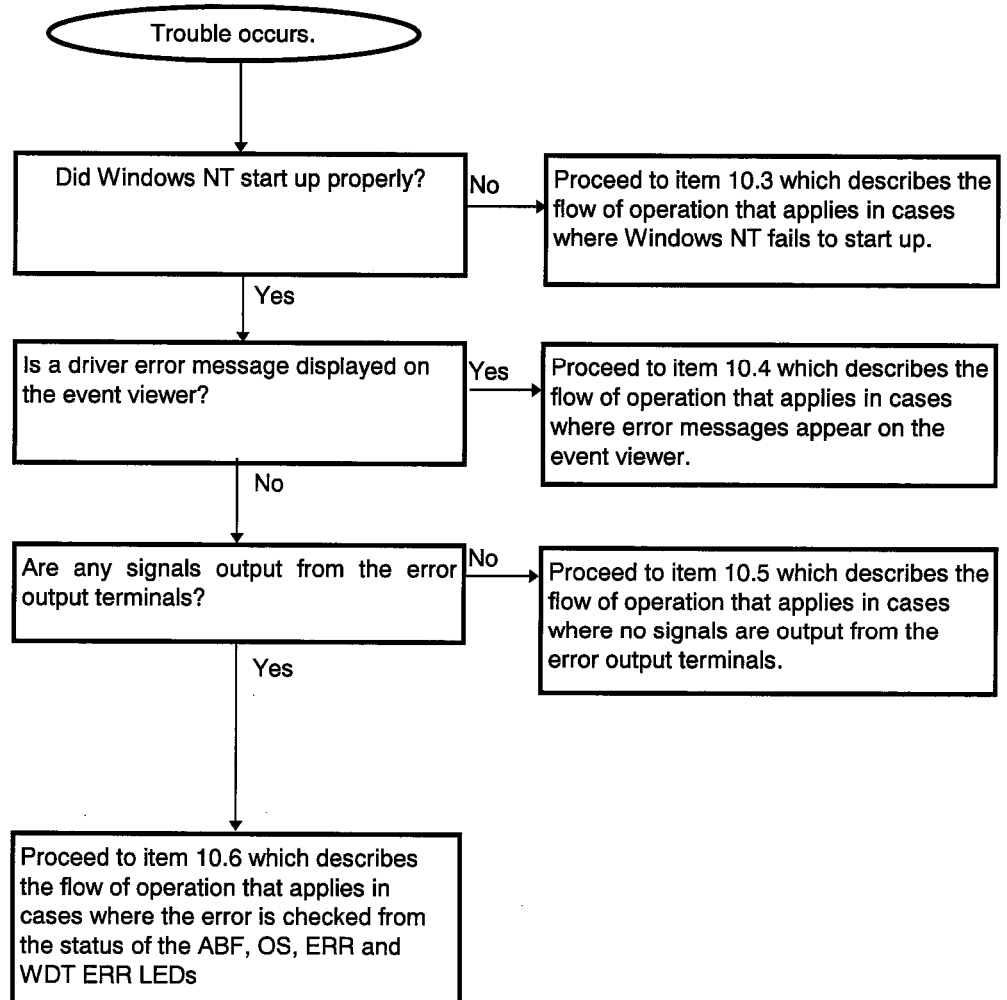

10.3 Flow in Cases where Windows NT Fails to Start Up

This item describes the flow of operation that applies in cases where Windows NT fails to start up.

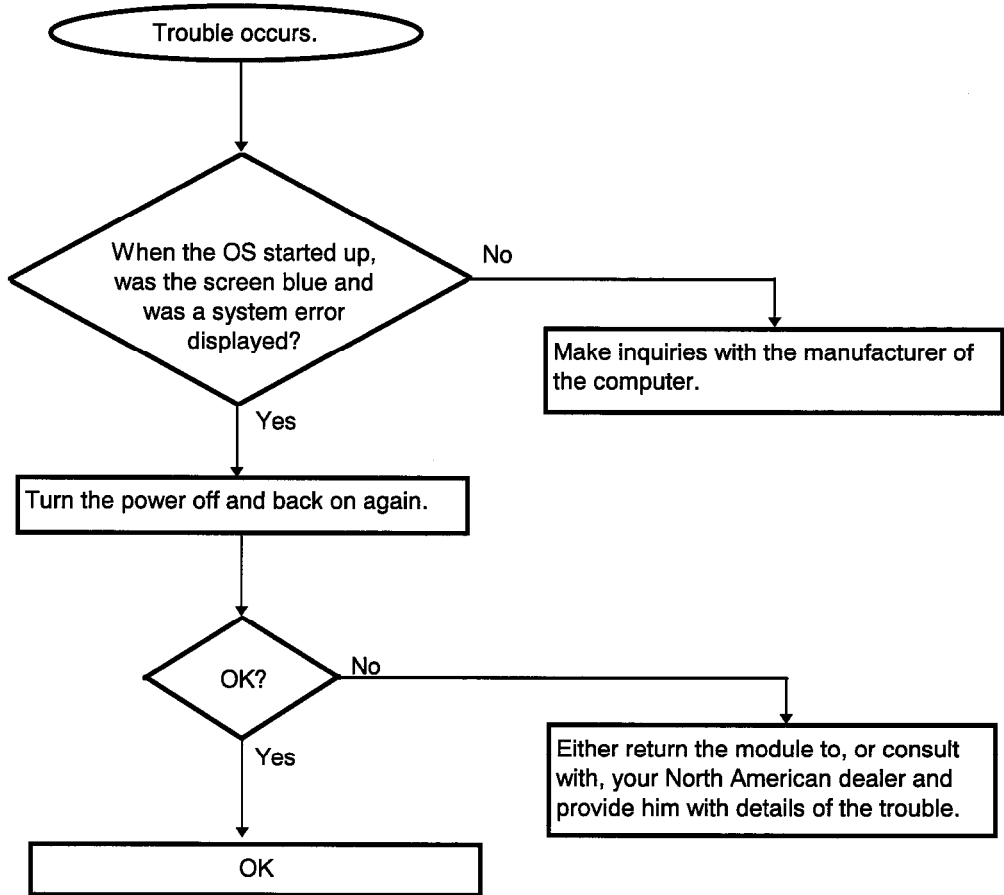

## 10.4 Flow in Cases where Error Messages Appear on Event Viewer

This item describes the flow of operation that applies in cases where error messages appear on the event viewer.

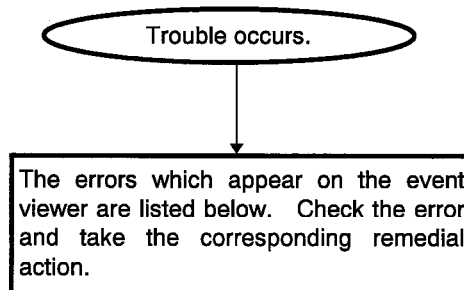

Event ID 0 to 65535	Error description	Remedial action
4096	The A70BDE-ABF board is not installed or the other hardware overlaps with the Input/Output address.	Change the ABF board's Input/Output address settings. Also, check whether the board has been installed.
4097	The maximum allowed number of installable boards has been exceeded.	Check that only one ABF board has been installed per IBM-PC/AT computer.
4098	The board competes with other devices because a mistake was found in setting such as MEM, INT and DIP switches.	Check all the setting switches, and check that none of the settings of the other option boards are duplicated.
4099	The RAM of the board is abnormal.	Check all the setting switches. If there is no fault in the setting switches, replace the ABF board.
4100	The A-bus is abnormal.	Check the expansion base unit's power supply. Check for defective contacts in the cables. Replace the ABF board.
4101	The power supply on the extension base unit is abnormal.	Check whether the POWER lamp of the power supply module on the expansion base unit is lit. If the POWER lamp is not lit, check whether power is being supplied to the module. Replace the power supply module if the power is being supplied.
4102	There is a module which is not supported.	Check the model names of the modules on the expansion base unit. Also, remove any modules which are not supported.
4103	There is an output module with a blown fuse.	Replace the fuse of the output module. If an output module of the AnS series is involved, check that the external power is being supplied properly.

## 10.5 Flow in Cases where No Signals are Output from Error Output Terminals

This item describes the flow of operation that applies in cases where no signals are output from the error output terminals.

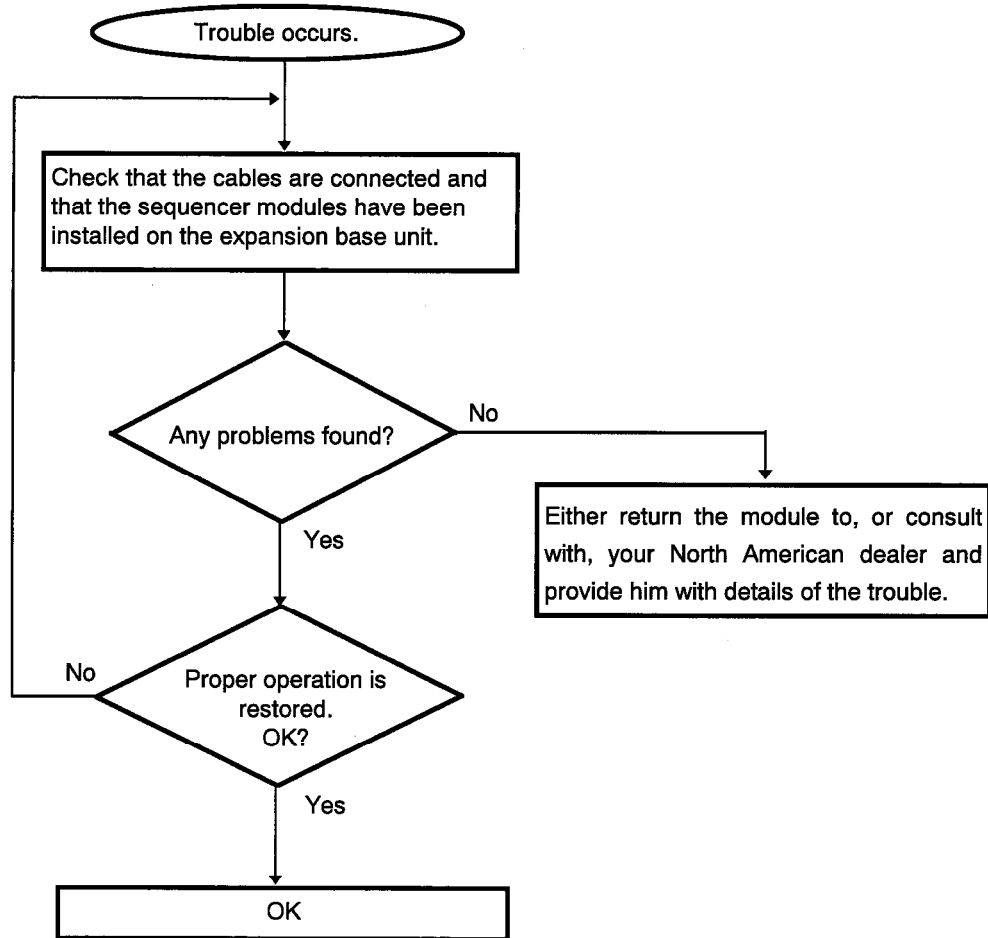

## 10.6 Flow in Cases where the Error is Checked from the Status of the ABF, OS, ERR and WDT ERR LEDs

This item describes the flow of operation that applies in cases where the error is checked from the status of the ABF, OS, ERR and WDT ERR LEDs. After checking out the error, take the remedial action in accordance with the flow indicated in the reference item column.

OS LED	ABF LED	ERR LED	WDT ERR LED	Error	Refer to item
Flashing	Off	Off	Off	System startup error	Item 10.6.1
Off	Off	Flashing	On	System WDT error	Item 10.6.2
Off	Off	Flashing	Off	User WDT error	Item 10.6.3
On	On	On	Off	Internal temperature rise error or AC cut-off detection error	Item 10.6.4
On	Off	On	Off	A-bus reset error processing, A-bus trouble error processing or gate array self-diagnosis error	Item 10.6.5

## 10.6.1 Flow in Cases where System Startup Error has Occurred

This item describes the flow of operation that applies in cases where a system startup error has occurred.

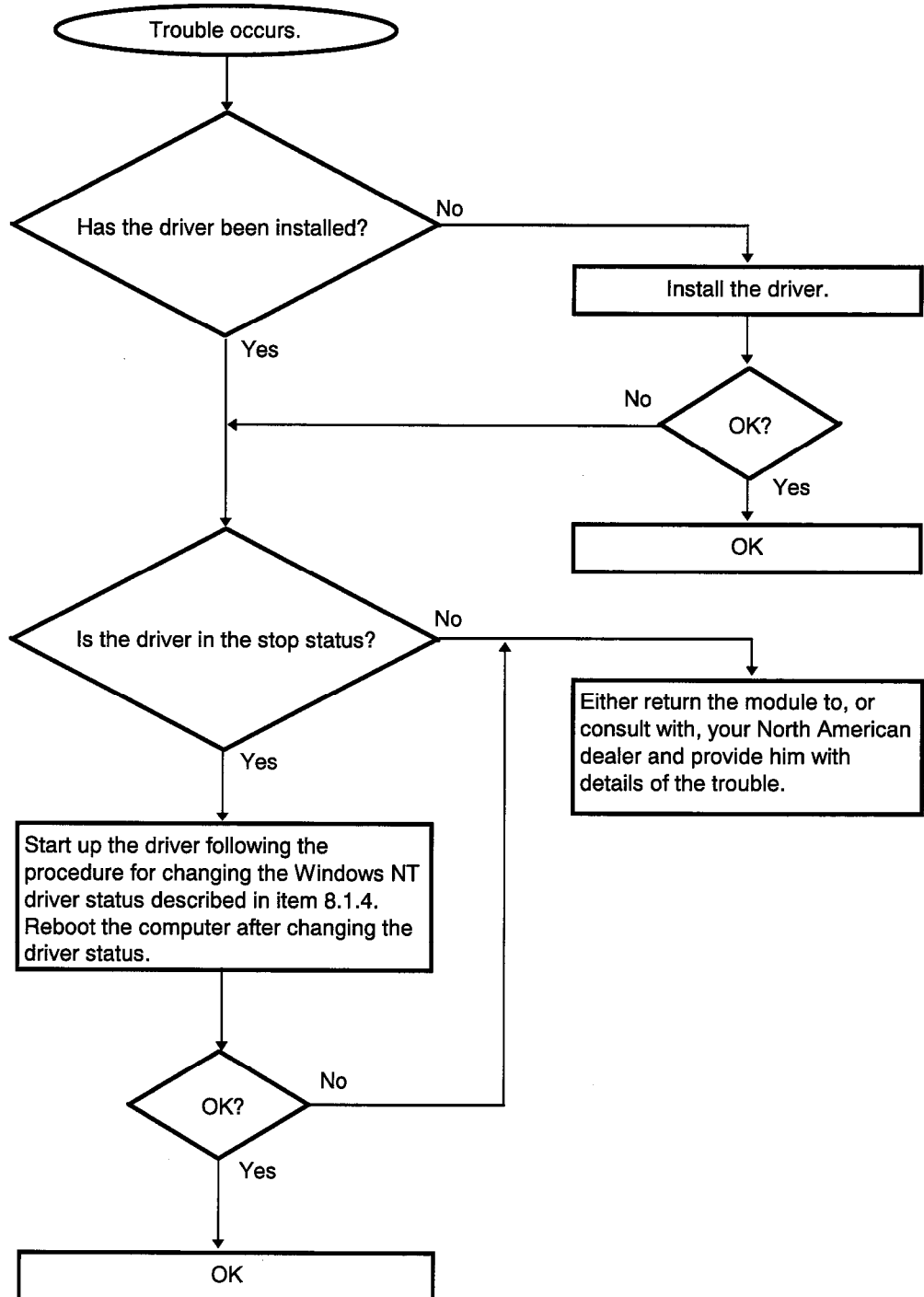

## 10.6.2 Flow in Cases where System WDT Error has Occurred

This item describes the flow of operation that applies in cases where a system WDT error has occurred.

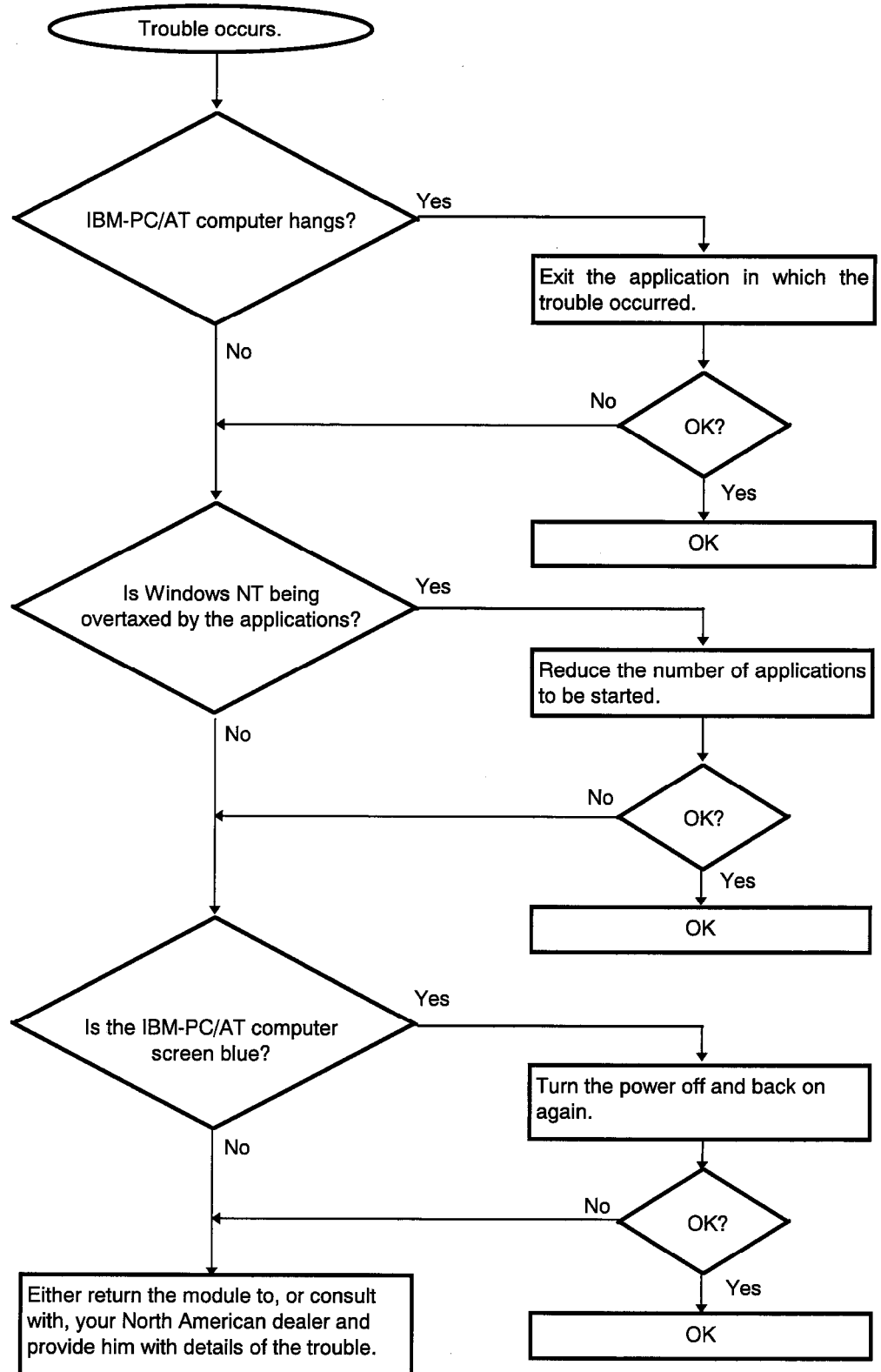



## 10.6.3 Flow in Cases where User WDT Error has Occurred

This item describes the flow of operation that applies in cases where a user WDT error has occurred.

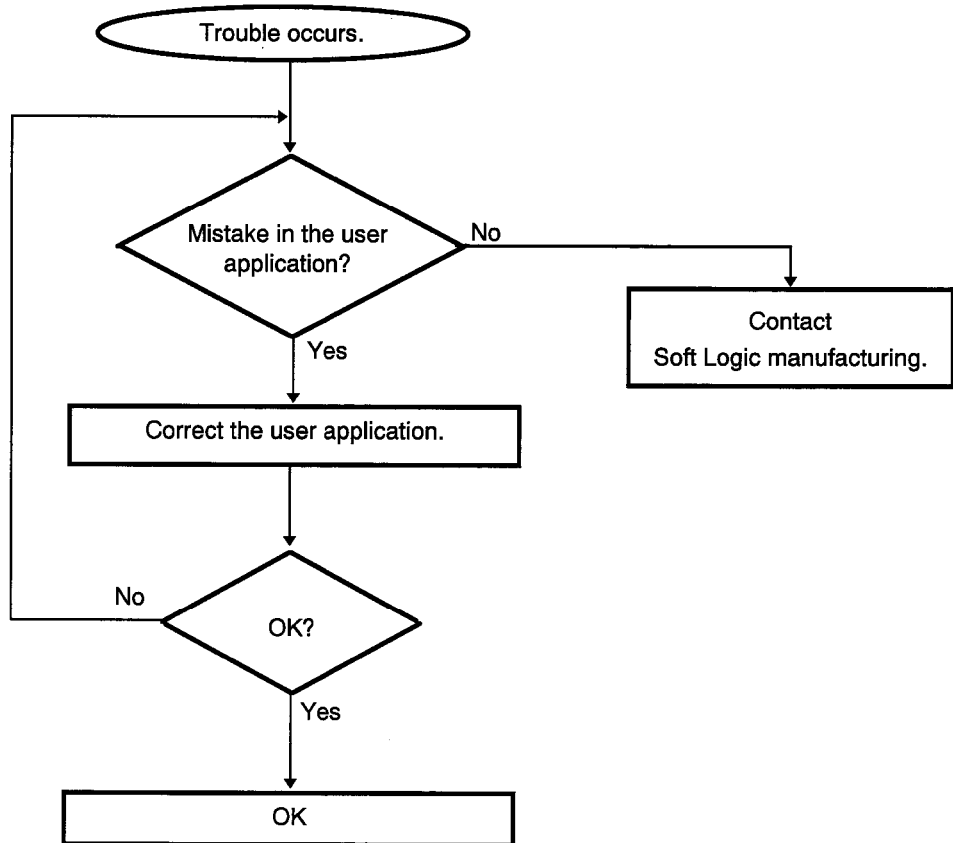

## 10.6.4 Flow in Cases where Internal Temperature Rise Error or AC Cut-off Detection Error has Occurred

This item describes the flow of operation that applies in cases where an internal temperature rise error or an AC cut-off detection error has occurred.

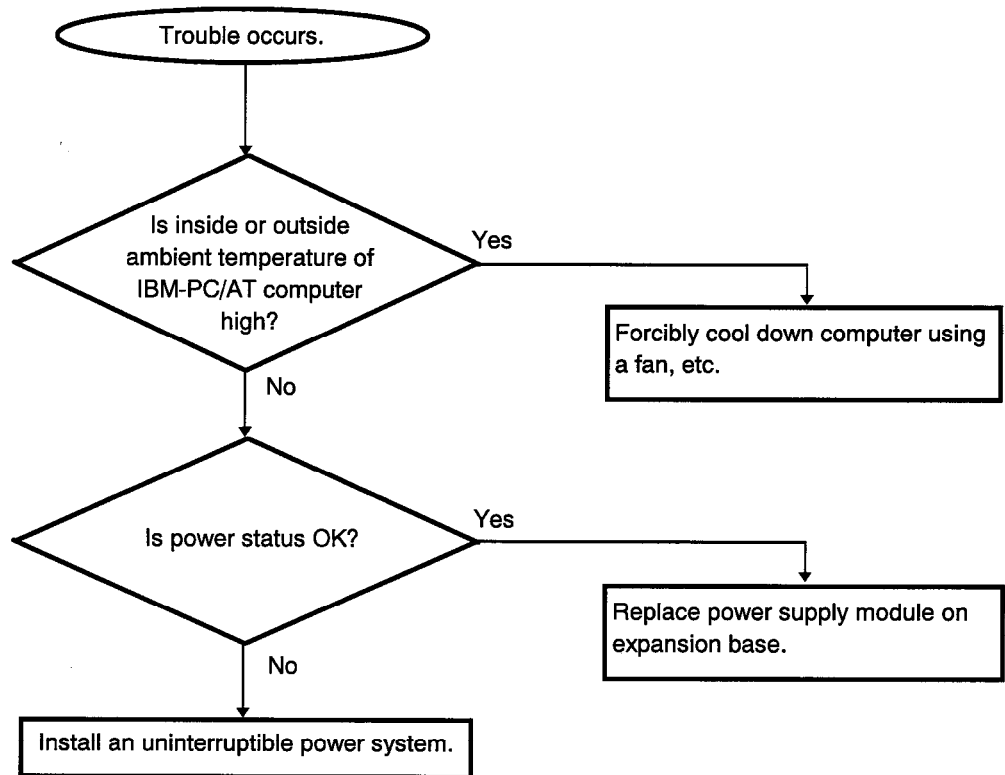

**10.6.5 Flow in Cases where A-bus Reset Error Processing, A-bus Trouble Error Processing or Gate Array Self-diagnosis Error has Occurred**

This item describes the flow of operation that applies in cases where an A-bus reset error processing, an A-bus trouble error processing or a gate array self-diagnosis error has occurred.

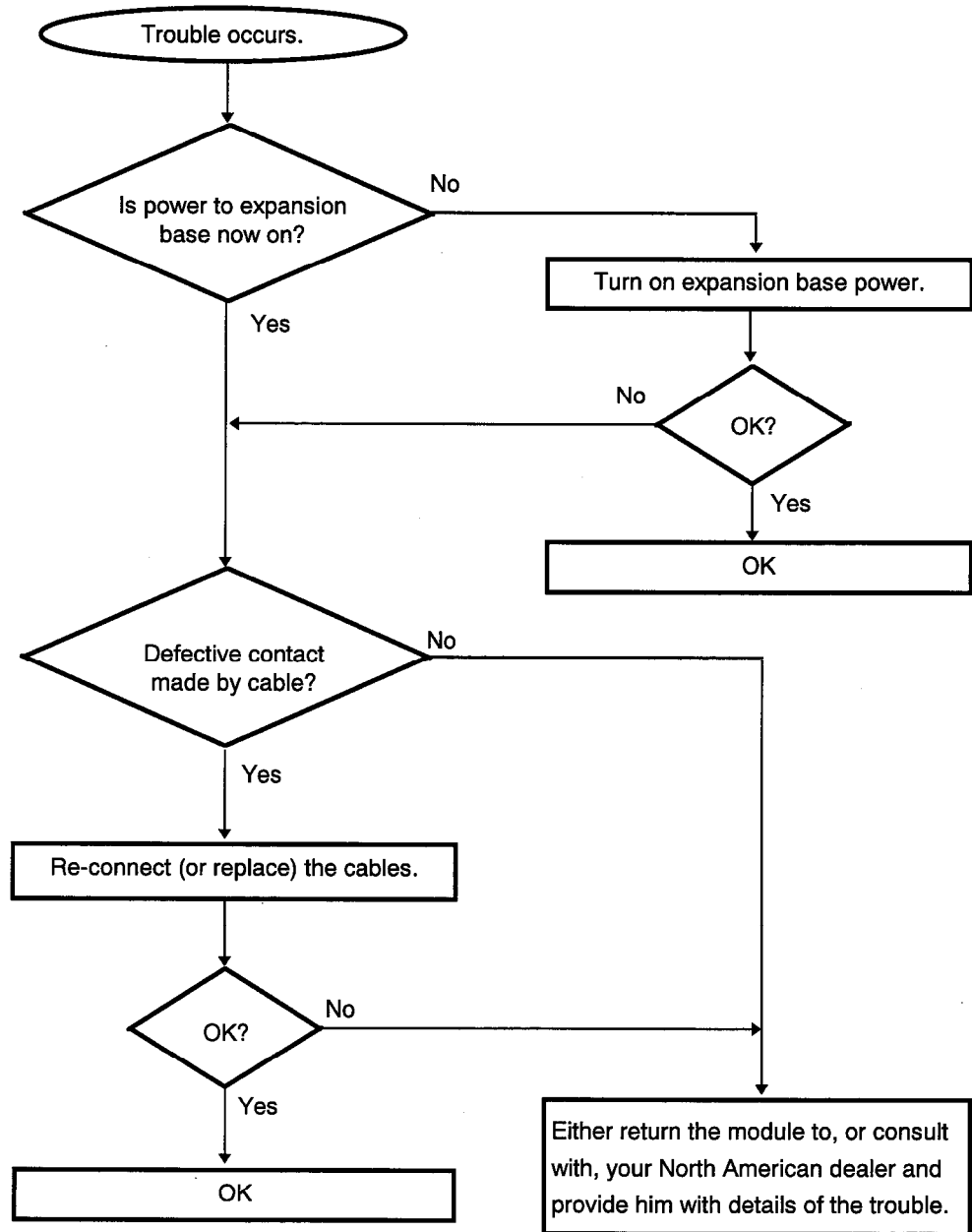

## 10.7 Flow in Cases where ABF Utility Error has Occurred

The error messages and the remedial actions for errors occurring during the use of ABF UTILITY are given below.

<b>Error message</b>	<b>Remedial action</b>
Specified Slot No. is outside the rang.	Check the specified slot number.
Specified Data is outside the rang.	Check the specified data.
Specified Address is outside the rang.	Check the specified address.
The maximum I/O point is exceeded.	Check the number of I/O points specified.
There is an item of the unsetting.	Check the items to be set.

## APPENDIX

## Appendix 1 List of Controllable Input/Output Modules and Special Function Modules

(1) When the A series is used

Module	Model name	Description	No. of points occupied [Input/Output allocation module type]	Current consumption (A)		Remarks
				5 V DC	24 V DC	
AC input module	AX10-UL	16 points, 100 V AC input module	16 [16 input points]	0.055	—	
	AX11	32 points, 100 V AC input module	32 [32 input points]	0.11	—	
	AX20	16 points, 200 V AC input module	16 [16 input points]	0.055	—	
	AX21	32 points, 200 V AC input module	32 [32 input points]	0.11	—	
	AX31	32 points, 12/24 V AC/DC input module	32 [32 input points]	0.11	—	
	AX31C	32 points, 12/24 V AC/DC input module	32 [32 input points]	0.11	—	
DC input module	AX40-UL	16 points, 12/24 V DC input module	16 [16 input points]	0.055	—	
	AX41	32 points, 12/24 V DC input module	32 [32 input points]	0.11	—	
	AX41C-S1	32 points, 12/24 V DC input module	32 [32 input points]	0.11	—	
	AX42	64 points, 12/24 V DC input module	64 [64 input points]	0.12	—	
	AX70-UL	16 points, 5/12/24 V DC input module	16 [16 input points]	0.055	—	
	AX71	32 points, 5/12/24 V DC input module	32 [32 input points]	0.11	—	
	AX80-UL	16 points, 12/24 V DC source input module	16 [16 input points]	0.055	—	
	AX81-S1	32 points, 12/24 V DC source input module	32 [32 input points]	0.105	—	
	AX81B	32 points, 24 V DC sync/source input module	64 [64 input points]	0.125	—	
Output module	AY10	16 points, relay contact, output module, for 2 A	16 [16 output points]	0.115	0.15	The (*1) mark denotes a source load module. Modules without this mark are sync load modules.
	AY11A	16 points, relay contact output module, for independent contact output	16 [16 output points]	0.115	0.15	
	AY11-UL	16 points, relay contact output module, with surge killer	16 [16 output points]	0.115	0.15	

Module	Model name	Description	No. of points occupied [Input/Output allocation module type]	Current consumption (A)		Remarks
				5 V DC	24 V DC	
Output module	AY13	32 points, relay contact output module, for 2 A	32 [32 output points]	0.23	0.29	
	AY22	16 points, triac output module, for 2 A (fused)	16 [16 output points]	0.305	—	
	AY23	32 points, triac output module, for 0.6 A (fused)	32 [32 output points]	0.59	—	
	AY40-UL	16 points, 12/24 V DC transistor output module, for 0.1 A	16 [16 output points]	0.115	0.016	
	AY41-UL	32 points, 12/24 V DC transistor output module, for 0.1 A	32 [32 output points]	0.23	0.04	
	AY42	64 points, 12/24 V DC transistor output module (fused)	64 [64 output points]	0.29	0.08	
	AY50-UL	16 points, 12/24 V DC transistor output module, for 0.5 A (fused)	16 [16 output points]	0.115	0.13	
	AY51-UL	32 points, 12/24 V DC transistor output module, for 0.5 A	32 [32 output points]	0.23	0.10	
	AY51-S1	32 points, 12/24 V DC transistor output module, for 0.3 A (fused)	32 [32 output points]	0.31	0.02	
	AY60	16 points, 12/24/48 V DC transistor output module, for 2 A (fused)	16 [16 output points]	0.115	0.13	
	AY60S	16 points, 12/24/48 V DC transistor output module, for 2 A	16 [16 output points]	0.075	0.006	
	AY60E	16 points, 12/24/48 V DC transistor output module, for 2 A (fused)	16 [16 output points]	0.115	0.006	
	AY70	16 points, for TTL, CMOS (5/12 V DC) output module, for 16 mA	16 [16 output points]	0.10	12 V DC 0.11	
	AY71	32 points, for TTL, CMOS (5/12 V DC) output module, for 16 mA	32 [32 output points]	0.20	12 V DC 0.20	

Module	Model name	Description	No. of points occupied [Input/Output allocation module type]	Current consumption (A)		Remarks
				5 V DC	24 V DC	
Output module	AY80 (1*)	16 points, 12/24 V DC transistor output module, for 0.5 A (fused)	16 [16 output points]	0.115	0.12	The short-circuit protection and overheating protection functions provided with the AY60EP, AY80EP, AY81EP and AY82EP are as follows.  [Short-circuit protection function] This protects the transistors from overcurrents caused by short-circuiting, etc. of the external wiring.  [Overheating protection function] This protects the transistors from damage resulting from abnormal temperature rises in the transistors due to external factors.
	AY80EP (1*)	16 points, 12/24 V DC transistor output module, for 0.8 A, with short-circuit protection and overheating protection functions	16 [16 output points]	0.115	0.22	
	AY81 (1*)	32 points, 12/24 V DC transistor output module, for 0.5 A	32 [32 output points]	0.23	0.10	
	AY81EP (1*)	32 points, 12/24 V DC transistor output module, for 0.8 A, with short-circuit protection and overheating protection functions	32 [32 output points]	0.23	0.44	
	AY82EP (1*)	64 points, 12/24 V DC transistor output module, for 0.1 A, with short-circuit protection and overheating protection functions	64 [64 output points]	0.29	0.10	
	AY60EP (1*)	16 points, 12/24/48 V DC transistor output module, 12/24 V DC for 2 A, 48 V DC for 0.8 A (fused)	16 [16 output points]	0.115	0.13	
	AY60EP (1*)	16 points, 12/24 V DC transistor output module, for 2 A, with short-circuit protection and overheating protection functions	16 [16 output points]	0.115	0.22	
Dynamic composite I/O module	A42XY	64 input points, 64 output points, dynamic scanning type	64 [64 output points]	0.11	0.235	This module performs Input/Output processing while it scans in 8-point increments independently of the CPU module.
Dummy module	AG62	Module enabling 16, 32, 48 or 64 points to be selected	Setting range [input setting range]	0.07	—	
Blank cover	AG60	Dust-proofing cover for unused slot	16 [16 points available]	—	—	

Module	Model name	Description	No. of points occupied [Input/Output allocation module type]	Current consumption (A)		Remarks
				5 V DC	24 V DC	
A/D converter module	A68AD	4 to 20 mA and 0 to $\pm 10$ V, analog input: 8 channels	32 [32 special points]	0.9	—	
	A616AD	4 to 20 mA and 0 to $\pm 10$ V, analog input: 8 channels; channels can be expanded to a maximum of 121 by A60MX (R)	32 [32 special points]	1.0	—	
	A60MX	Multiplex module (IC relay), analog input: 16 channels	16 [16 points available]	0.65	—	Used in conjunction with A616AD or A616TD.
	A60MXR	Multiplex module (mercury relay), analog input: 16 channels	16 [16 points available]	0.5	—	
Temperature/digital converter module	A616TD	For detecting temperature by thermocouple (when A60MXT is connected); 0 to $\pm 10$ V, 0 to 20 mA (when A60MX (R) is connected)	32 [32 special points]	1.0	—	
	A60MXT	Multiplex module, temperature input: 15 channels; used in conjunction with A616TD to detect temperature by means of thermocouple.	32 [16 points available in first half] [16 points available in second half]	0.8	—	Used in conjunction with A616TD.
	A68RD3	-180 to 600°C temperature input module (3-wire type of platinum resistance thermometer element)	32 [32 special points]	0.94	—	
	A68RD4	-180 to 600°C temperature input module (4-wire type of platinum resistance thermometer element)	32 [32 special points]	0.75	—	
D/A converter module	A68DAV	0 to $\pm 10$ V, analog output: 8 channels	32 [32 special points]	0.15	0.2	
	A68DAI-SI	0 to 20 mA, analog output: 8 channels	32 [32 special points]	0.15	0.4	
	A62DA	4 to 20 mA, 0 to $\pm 10$ V, analog output, 12 bits, 2 channels	32 [32 special points]	0.6	0.35	



Module	Model name	Description	No. of points occupied [Input/Output allocation module type]	Current consumption (A)		Remarks
				5 V DC	24 V DC	
D/A converter module	A616DAV	0 to $\pm 10$ V/0 to $\pm 5$ V, 1/4000 resolution, analog output: 16 channels	32 [32 special points]	0.38	—	15 V DC (A68P) is required.
	A616DAI	4 to 20 mA, 1/4000 resolution, analog output: 16 channels	32 [32 special points]	0.3	—	
High-speed counter module	AD61	Binary 24 bits, 1/2 phase input, reversible counter, 50 kpps, 2 channels	32 [32 special points]	0.3	—	
Positioning module	AD75P1-S3	Pulse train output for 1-axis positioning control, stepper motor usable	32 [32 special points]	0.7	—	
	AD75P2-S3	Pulse train output for 2-axis positioning control (independent or simultaneous 2 axes, linear interpolation, circular interpolation), stepper motor usable	32 [32 special points]	0.7	—	
	AD75P3-S3	Pulse train output for 3-axis positioning control (independent or simultaneous 2 axes, linear interpolation, circular interpolation), stepper motor usable	32 [32 special points]	0.7	—	
	AD71	Pulse train output for positioning control, 2 axes (independent or simultaneous 2 axes, linear interpolation)	32 [32 special points]	1.5	—	
	AD72	For positioning control, analog voltage output (0 to $\pm 10$ V), 2 axes (independent or simultaneous 2 axes, linear interpolation)	48 [16 points available in first half] [32 points available in second half]	0.9	—	
Memory card Centronics interface module	AD 59	32 KB memory, battery back-up, connectable with printer complying with Centronics standard	32 [32 special points]	0.3	—	

(2) When the AnS series is used

Module	Model name	Description	No. of points occupied [Input/Output allocation module type]	Current consumption (A)		Remarks
				5 V DC	24 V DC	
AC input module	A1SX10	16 points, 100 V AC input module	16 [16 input points]	0.05	—	
	A1SX20	16 points, 200 V AC input module	16 [16 input points]	0.05	—	
	A1SX30	16 points, 12/24 V AC, DC 12/24 V input module	16 [16 input points]	0.05	—	
DC input module	A1SX40	16 points, 12/24 V DC input module	16 [16 input points]	0.05	—	
	A1SX40-S1	16 points, 12/24 V DC input module	16 [16 input points]	0.05	—	
	A1SX40-S2	16 points, 24 V DC input module	16 [16 input points]	0.05	—	
	A1SX41	32 points, 12/24 V DC input module	32 [32 input points]	0.08	—	
	A1SX41-S2	32 points, 24 V DC input module	32 [32 input points]	0.08	—	
	A1SX42-S2	64 points, 24 V DC input module	64 [64 input points]	0.09	—	
	A1SX42	64 points, dynamic input module	64 [64 input points]	0.09	—	
	A1SX71	32 points, 5/12/24 V DC input module	32 [32 input points]	0.075	—	
	A1SX80	16 points, 12/24 V DC sync/source input module	16 [16 input points]	0.05	—	
	A1SX80-S1	16 points, 24 V DC sync/source input module	16 [16 input points]	0.05	—	
	A1SX80-S2	16 points, 24 V DC sync/source input module	16 [16 input points]	0.05	—	
	A1SX81	32 points, 12/24 V DC sync/source input module	32 [32 input points]	0.08	—	
	A1SX81-S2	32 points, 24 V DC sync/source input module	32 [32 input points]	0.08	—	
Output module	A1SY10	16 points, relay contact, output module (2 A)	16 [16 output points]	0.12	0.09	
	A1SY18A	8 points, relay contact output module (2 A) for independent contact	16 [16 output points]	0.24	0.075	
	A1SY22	16 points, triac output module (0.6 A)	16 [16 output points]	0.27	(200 V AC) 0.004	
	A1SY28A	8 points, triac output module, (1 A) All points independent	16 [16 output points]	0.13	—	

Module	Model name	Description	No. of points occupied [Input/Output allocation module type]	Current consumption (A)		Remarks
				5 V DC	24 V DC	
Output module	A1SY40	16 points, 12/24 V DC transistor output module (0.1 A), sync type	16 [16 output points]	0.27	0.016	
	A1SY41	32 points, 12/24 V DC transistor output module (0.1 A), sync type	32 [32 output points]	0.50	0.016	
	A1SY42	64 points, 12/24 V DC transistor output module (0.1 A), sync type	64 [64 output points]	0.93	0.016	
	A1SY50	16 points, 12/24 V DC transistor output module (0.5 A), sync type	16 [16 output points]	0.12	0.12	
	A1SY60	16 points, 24 V DC transistor output module (2 A), sync type	16 [16 output points]	0.12	0.015	
	A1SY60E	16 points, 5/12/24 V DC transistor output module (2 A), source type	16 [16 output points]	0.2	0.010	
	A1SY68A	8 points, 5/12/24 V/48 V DC transistor output module, sync/source type, all points independent	16 [16 output points]	0.11	—	
	A1SY71	32 points, 5/12 V DC transistor output module (0.016 A), sync type	32 [32 output points]	0.40	0.15	
	A1SY80	16 points, 12/24 V DC transistor output module (0.8 A), source type	16 [16 output points]	0.12	0.04	
	A1SY81	32 points, 12/24 V DC transistor output module (0.1 A), source type	32 [32 output points]	0.50	0.016	
Input/output combined module	A1SH42	32 points, 12/24 V DC input module 32 points, 12/24 V DC transistor output module (0.1 A), sync type	32 [32 output points]	0.50	0.008	
	A1SX48Y18	8 points, 24 V DC input module 8 points, relay contact output module	16 [16 output points]	0.085	0.045	
	A1SX48Y58	8 points, 24 V DC input module 8 points, 12/24 V DC transistor output module	16 [16 output points]	0.06	0.06	

Module	Model name	Description	No. of points occupied [Input/Output allocation module type]	Current consumption (A)		Remarks
				5 V DC	24 V DC	
High-speed counter module	A1SD61	32 points, signed binary, 50 kpps, 1 channel	32 [32 special points]	0.35	—	
	A1SD62	32 points, 24-bit binary, 100 kpps, 2 channels	32 [32 special points]	0.1	—	
A/D converter module	A1S64AD	4 to 20 mA, 0 to 10 V, analog, 4 channels	32 [32 special points]	0.4	—	
	A1S68AD	0 to 20 mA, -10 to 10 V, analog, 8 channels	32 [32 special points]	0.4	—	
D/A converter module	A1S62DA	4 to 20 mA, 0 to 10 V, analog output: 2 channels	32 [32 special points]	0.8	—	
	A1S68DAV	-10 to 10 V, analog output: 8 channels	32 [32 special points]	0.65	—	
	A1S68DAI	4 to 20 mA, analog output: 8 channels	32 [32 special points]	0.85	—	
Temperature /digital converter module	A1S62RD3	For Pt100 (3-wire type) connections, temperature input: 2 channels	32 [32 special points]	0.54	—	
	A1S62RD4	For Pt100 (4-wire type) connections, temperature input: 2 channels	32 [32 special points]	0.44	—	
Analog I/O module	A1S63ADA	Analog input: 2 channels, simple loop control enabled, analog output: 1 channel	32 [32 special points]	0.8	—	
Pulse catcher module	A1SP60	Module for inputting pulses with short ON time (min. 0.5 ms pulses), 16 input points	16 [16 output points]	0.055	—	
Analog timer module	A1ST60	Module enabling timer settings (0.1 to 1.0 sec, 1 to 10 sec, 10 to 60 sec, 60 to 600 sec) to be changed using variable resistors, analog timer, 8 points	16 [16 output points]	0.55	—	
Positioning module	A1SD70	Analog voltage output (0 to ±10 V) for 1-axis positioning control, speed control, speed/position control	48 16 points available in first half 32 points in second half 32 [32 special points]	0.3	—	
	A1SD71-S2	Pulse train output for positioning control, speed control, speed/position control, 2 axes (independent or simultaneous 2 axes, linear interpolation)		0.8	—	

Module	Model name	Description	No. of points occupied [Input/Output allocation module type]	Current consumption (A)		Remarks
				5 V DC	24 V DC	
Positioning module	A1SD75P1-S3	Pulse train output for 1-axis positioning control, stepper motor usable	32 [32 special points]	0.7	—	
	A1SD75P2-S3	Pulse train output for 2-axis positioning control, stepper motor usable	32 [32 special points]	0.7	—	
	A1SD75P3-S3	Pulse train output for 3-axis positioning control, stepper motor usable	32 [32 special points]	0.7	—	
MELSECNET/MINI-S3 master module	A1SJ71PT32-S3	For MELSECNET/MINI-S3 master station, maximum of 64 stations, remote input/output of total of 512 input/output points, remote terminal control exercised	Input/Output dedicated mode: 32 [32 special points] Expansion mode: 48 [48 special points]	0.35	—	

**Appendix 2** Outline Drawings of A70BDE-ABF

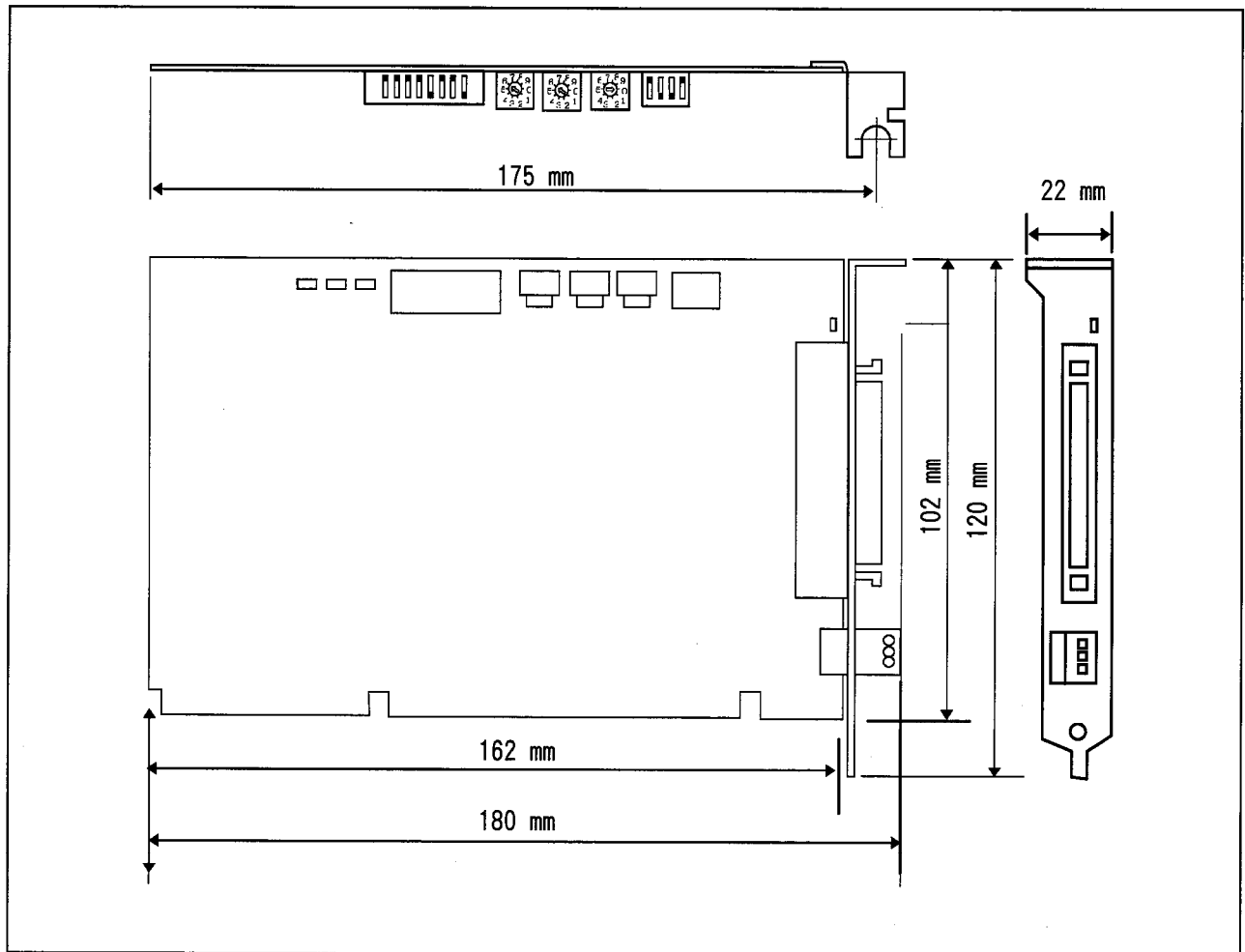



FOR IBM-PC/AT COMPUTERS  
MODEL A70BDE-ABF A-BUS CONTROL INTERFACE BOARD

# User's Manual

MODEL	A70BDE-ABF-U-E
MODEL CODE	13JL01
IB(NA)66754-B(9709)MEE	

 **mitsubishi electric corporation**

HEAD OFFICE : MITSUBISHI DENKI BLDG MARUNOUCHI TOKYO 100-0005 TELEX : J24532 CABLE MELCO TOKYO  
NAGOYA WORKS : 1-14 , YADA-MINAMI 5 , HIGASHI-KU, NAGOYA , JAPAN

When exported from Japan, this manual does not require application to the  
Ministry of International Trade and Industry for service transaction permission.

Specifications subject to change without notice.